



Transnet Freight Rail RME, a division of

TRANSNET SOC LTD

Registration Number 1990/000900/30

[hereinafter referred to as **Transnet**]

REQUEST FOR QUOTATION (RFQ) No RME RBY 098/2014

**FOR THE SUPPLY OF: VARIOUS ELECTRICAL MATERIALS INCLUDING A KIOSK
AND DISTRIBUTION BOARD**

FOR DELIVERY TO: RICHARDS BAY

ISSUE DATE: 04 NOVEMBER 2014 – 10 NOVEMBER 2014

COMPULSORY BRIEFING SESSION: 11 NOVEMBER 2014 AT 11:00

**BRIEFING LOCATION: OLD NAVAL BASE, COMMODORES CLOSE,
MEERENSEE, RICHARDS BAY, 3901**

CLOSING DATE: 13 NOVEMBER 2014

CLOSING TIME: 10:00

PREVIEW COPY ONLY

Section 1 NOTICE TO BIDDERS

Quotations which must be completed as indicated in Section 2 of this RFQ are to be submitted as follows:

METHOD:

Tender box / fax / e-mail

CLOSING VENUE:

Transnet Freight Rail RME,

The Chairman of the Acquisition Council,
Inyanda House 1, 21 Wellington Road,
Parktown, Gauteng

Fax numbers and e-mail details are as follows: Fax numbers: 011 774

9760, 011 774 9129 or 011 774 9186 and e-mail:

Nomsa.Maseko@transnet.net

Note: Please fax/e-mail your "Proof" (fax report or e-mail proof) with the first page of the tender document that is stamped with company details to, 086 515 9978 or to

TRANSPORT@TRANSNETNET.CO.ZA OR TRANSPORT@TRANSNET.CO.ZA
with the first page of the tender document that is stamped with company details to, 086 515 9978 or to

1 Responses to RFQ

Responses to this RFQ [Quotations] must not include documents or reference relating to any other quotation or proposal. Any additional conditions must be embodied in an accompanying letter.

2 Broad-Based Black Economic Empowerment [B-BBEE]

Transnet fully endorses and supports the Government's Broad-Based Black Economic Empowerment Programme and it would therefore prefer to do business with local business enterprises who share these same values. Transnet will accordingly allow a "preference" to companies who provide a valid B-BBEE Verification Certificate. All procurement transactions will be evaluated according to the B-BBEE Verification Certificate.

2.1 B-BBEE Scorecard and Rating

As prescribed in terms of the Preferential Procurement Policy Framework Act (PPPFA), Act 5 of 2000 and its Regulations, Respondents are to note that the following preference point system is applicable to all bids:

- the 80/20 system for requirements with a Rand value of up to R1 000 000 (all applicable taxes included).
- Bidders are to note that if the 80/20 preference point system is stipulated in this RFP and all Bids received exceed R1 000 000.00, the RFP must be cancelled.

The value of this bid is estimated to be below R1000 000 (all applicable taxes included) and therefore the **80/20** system shall be applicable.

When Transnet invites prospective suppliers to submit Proposals for its various expenditure programmes, it requires Respondents to have their B-BBEE status verified in compliance with the

Codes of Good Practice issued in terms of the Broad Based Black Economic Empowerment Act No. 53 of 2003.

The Department of Trade and Industry recently revised the Codes of Good Practice on 11 October 2013 [Government Gazette No. 36928]. The Revised Codes will replace the Black Economic Empowerment Codes of Good Practice issued on 9 February 2007. The Revised Codes provide for a one year transitional period starting 11 October 2013. During the transitional period, companies may elect to be measured in terms of the Revised Codes or the 2007 version of the Codes. After the first year of the implementation of the Revised Codes, B-BBEE compliance will be measured in terms of the Revised Codes without any discretion. Companies which are governed by Sector-specific Codes will be measured in terms of those Sector Codes.

As such, Transnet will accept B-BBEE certificates issued based on the Revised Codes. Transnet will also continue to accept B-BBEE certificates issued in terms of the 2007 version of the Codes provided it was issued before 10 October 2014. Thereafter, Transnet will only accept B-BBEE certificates issued based on the Revised Codes.

Respondents are required to complete Annexure A [the B-BBEE Preference Point Claim Form] and submit it together with proof of their B-BBEE Status as stipulated in the Claim Form in order to obtain preference points for their B-BBEE status.

Note: Failure to submit a valid and original B-BBEE certificate or a certified copy thereof at the Closing Date of this RFQ will result in a score of zero being allocated for B-BBEE.

[Refer clause 20 below for Returnable Documents Required]

3 Communication

- a) Respondents are warned that a response will be liable for disqualification should any attempt be made by a Respondent either directly or indirectly to canvass any officer(s) or employee of Transnet in respect of this RFQ between the closing date and the date of the award of the business.
- b) A Respondent may, however, before the closing date and time, direct any written enquiries relating to the RFQ to the following Transnet employee:
Name: Mari Maritz Email: mari.maritz@transnet.net
- c) Respondents may also, at any time after the closing date of the RFQ, communicate with the Regional Supply Chain Manager, Lizelle Smith on any matter relating to its RFQ response:

Telephone 035 905 4609 Email lizelle.smith@transnet.net

4 Tax Clearance

The Respondent's original and valid Tax Clearance Certificate must accompany the Quotation. Note that no business shall be awarded to any Respondent whose tax matters have not been declared by SARS to be in order.

5 VAT Registration

The valid VAT registration number must be stated here: _____ *[if applicable].*

6 Legal Compliance

The successful Respondent shall be in full and complete compliance with any and all applicable national and local laws and regulations.

7 Changes to Quotations

Changes by the Respondent to its submission will not be considered after the closing date and time.

8 Pricing

All prices must be quoted in South African Rand on a fixed price basis, excluding VAT.

9 Prices Subject to Confirmation

Prices quoted which are subject to confirmation will not be considered.

10 Negotiations

Transnet reserves the right to undertake post-tender negotiations with selected Respondents or any number of short-listed Respondents.

11 Binding Offer

Any Quotation furnished pursuant to this RFQ shall be deemed to be an offer. Any exceptions to this statement must be clearly and specifically indicated.

12 Disclaimers

Transnet is not committed to any course of action as a result of its issuance of this RFQ and/or its receipt of a Quotation in response to it. Please note that Transnet reserves the right to:

- modify the RFQ's goods / service(s) and request Respondents to re-bid on any changes;
- reject any Quotation which does not conform to instructions and specifications which are detailed herein;
- disqualify Quotations submitted after the stated submission deadline;
- not necessarily accept the lowest priced Quotation;
- reject all Quotations, if it so decides;
- place an order in connection with this Quotation at any time after the RFQ's closing date;
- award only a portion of the proposed goods / service/s which are reflected in the scope of this RFQ;
- split the award of the order/s between more than one Supplier/Service Provider; or
- make no award at all.

Transnet reserves the right to award business to the highest scoring bidder/s unless objective criteria justify the award to another bidder.

13 Transnet's supplier integrity pact

Transnet's Integrity Pact requires a commitment from suppliers and Transnet that they will not engage in any corrupt and fraudulent practices, anti-competitive practices; and act in bad faith towards each other.

The Integrity Pact also serves to communicate Transnet's Gift Policy as well as the remedies available to Transnet where a Respondent contravenes any provision of the Integrity Pact.

Respondents are required to familiarise themselves with the contents of the Integrity Pact which is available on the Transnet Internet site [www.transnet.net/Tenders/Pages/default.aspx] or on request. Furthermore, Respondents are required to certify that they have acquainted themselves with all the documentation comprising the Transnet Integrity Pact and that they fully comply with all the terms and conditions stipulated in the Transnet Supplier Integrity Pact as follows:

YES	NO
------------	-----------

Should a Respondent need to declare previous transgressions or a serious breach of law in the preceding 5 years as required by Annexure A to the Integrity Pact, such declaration must accompany the Respondent's bid submission.

14 Respondent's Samples

Respondents are not required to submit samples of the Goods tendered for.

15 Evaluation Criteria

Transnet will utilise the following criteria [not necessarily in this order] in choosing a Supplier/Service Provider, if so required:

Criterion/Criteria	Explanation
Administrative responsiveness	Completeness of response and returnable documents
Substantive responsiveness	<p>Prequalification criteria, if any, must be met and whether the Bid materially complies with the scope and/or specification given.</p> <ul style="list-style-type: none"> • All items on the Pricing Schedule should be priced; if not it will result in a bid being disqualified • To facilitate like-for-like comparison bidders must submit pricing strictly in accordance with this price schedule and not utilise a different format. Deviation from this pricing schedule could result in a bid being disqualified.
Functionality Threshold	As prescribed in terms of the Preferential Procurement Policy Framework Act (PPPFA), Act 5 of 2000 and its Regulations, Respondents are to note that functionality is included as threshold with a prescribed percentage threshold of 60%. Compliance to specification, delivery lead-time and regional footprint will be considered as part of the technical evaluation [complete Annexure B – Technical Questionnaire]

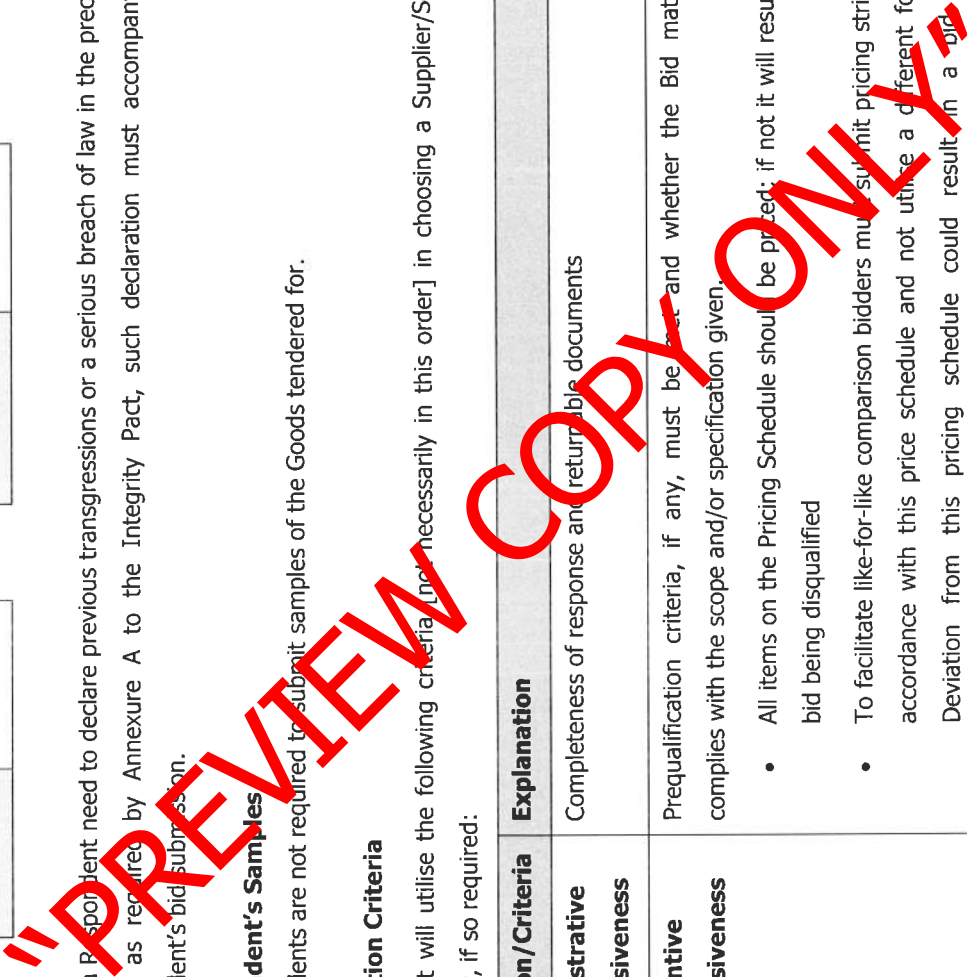

<p>Final weighted evaluation based on 80/20 preference point system as indicated in paragraph 2</p>	<ul style="list-style-type: none"> • Pricing and price basis [firm] - whilst not the sole factor for consideration, competitive pricing and overall level of unconditional discounts¹ will be critical • B-BBEE status of company - Preference points will be awarded to a bidder for attaining the B-BBEE status level of contribution in accordance with the table indicated in Annexure A.
--	--

16 Validity Period

Transnet desires a validity period of 6 [six] weeks from the closing date of this RFQ.

This RFQ is valid until _____.

17 Banking Details

BANK: _____

BRANCH NAME / CODE: _____

ACCOUNT HOLDER: _____

ACCOUNT NUMBER: _____

18 Company Registration

Registration number of company / C.C. _____

Registered name of company / C.C. _____

19 Disclosure of Prices Quoted

Respondents must indicate here whether Transnet may disclose their quoted prices and conditions to other Respondents:

YES NO

20 Returnable Documents

Returnable Documents means all the documents, Sections and Annexures, as listed in the tables below.

a) Respondents are required to submit with their Quotations the **mandatory Returnable Documents**, as detailed below.

Failure to provide all these Returnable Documents at the Closing Date and time of this RFQ will result in a Respondent's disqualification. Respondents are therefore urged to ensure that all these Documents are returned with their Quotations.

¹ Only unconditional discounts will be taken into account during evaluation. A discount which has been offered conditionally will, despite not being taken into account for evaluation purposes, be implemented when payment is effected.

All Sections, as indicated in the footer of each page, must be signed, stamped and dated by the Respondent. Please confirm submission of these mandatory Returnable Documents by so indicating [Yes or No] in the table below:

Mandatory Returnable Documents	Submitted [Yes or No]
SECTION 2 : Quotation Form	
ANNEXURE B : Technical Submission/Questionnaire	
ANNEXURE B1: Brand names and SABS/SANS codes of goods offered for each item quoted in Section 2, Quotation form, items 1 to 29	
ANNEXURE B2 / Letter of company or manufacturer certifying/guaranteeing that they can manufacture type tested boards and bus bars	
ANNEXURE B3: Delivery Lead time on items required	
ANNEXURE B4: Regional Footprint - Geographical Position of company	
ANNEXURE E : Certificate of attendance of site meeting / RFQ briefing	

- a) In addition to the requirements of section (a) above, Respondents are further required to submit with their Quotations the following essential Returnable Documents as detailed below.

Failure to provide all these Returnable Documents may result in a Respondent's disqualification. Respondents are therefore urged to ensure that all these documents are returned with their Quotations.

All Sections, as indicated in the footer of each page, must be signed, stamped and dated by the Respondent. Please confirm submission of these essential Returnable Documents by so indicating [Yes or No] in the table below:

Returnable Documents	Submitted [Yes or No]
SECTION 1 : Notice to Bidders	
- Valid and original B-BBEE Verification Certificate or certified copy thereof [Large Enterprises and QSEs] Note: failure to provide a valid B-BBEE Verification Certificate at the closing date and time of the RFQ will result in an automatic score of zero for preference	
- Valid and original B-BBEE certificate/sworn affidavit or certified copy thereof from auditor, accounting officer or SANAS accredited Verification Agency [EMEs] Note: failure to provide a valid B-BBEE Verification Certificate at the closing date and time of the RFQ will result in an automatic score of zero being allocated for preference	
- In the case of Joint Ventures, a copy of the Joint Venture Agreement or written confirmation of the intention to enter into a Joint Venture Agreement	
- Original valid Tax Clearance Certificate [Consortia / Joint Ventures must submit a separate Tax Clearance Certificate for each party]	

Returnable Documents	Submitted [Yes or No]
SECTION 3: Vendor Application Form	
<ul style="list-style-type: none"> • Original cancelled cheque or bank verification of banking details 	
<ul style="list-style-type: none"> • Certified copies of IDs of shareholder/directors/members [as applicable] 	
<ul style="list-style-type: none"> • Certified copies of the relevant company registration documents from Companies and Intellectual Property Commission (CIPC) 	
<ul style="list-style-type: none"> • Certified copies of the company's shareholding/director's portfolio 	
<ul style="list-style-type: none"> • Entity's letterhead 	
<ul style="list-style-type: none"> • Certified copy of VAT Registration Certificate [RSA entities only] 	
<ul style="list-style-type: none"> • Certified copy of Valid Company Registration Certificate [if applicable] 	
ANNEXURE A – B-BBEE Preference Points Claim Form	
ANNEXURE C: Specification of Goods	
ANNEXURE D : Drawings	

PREVIEW COPY ONLY

Section 2 QUOTATION FORM

I/We _____ hereby offer to supply the goods/services at the prices quoted in the Price Schedule below, in accordance with the conditions related thereto.

I/We agree to be bound by those terms and conditions in:

- the Standard Terms and Conditions for the Supply of Goods or Services to Transnet [available on request]; and
- any other standard or special conditions mentioned and/or embodied in this Request for Quotation.

I/We accept that unless Transnet should otherwise decide and so inform me/us, this Quotation [and, if any, its covering letter and any subsequent exchange of correspondence], together with Transnet's acceptance thereof shall constitute a binding contract between Transnet and me/us.

I/We further agree that if, after I/we have been notified of the acceptance of my/our Quotation, I/we fail to deliver the said goods/services within the delivery lead-time quoted, Transnet may, without prejudice to any other legal remedy which it may have, cancel the order and recover from me/us any expenses incurred by Transnet in calling for Quotation refresh and/or having to accept any less favourable offer.

Price Schedule

I/We quote as follows for the goods required, on "delivered nominated destination" basis, excluding VAT:

Item No	Description of Goods /Services	Unit of Measure	Quantity	Unit Price (ZAR)	Total Price (ZAR)
1	PT12-76 wideX3m long light duty cable trays	M	30		
2	PT19-101 wideX3m long light duty cable trays	M	30		
3	T50I PVC ties	EA	8		
4	Glands + ShroudsNo.1	EA	120		
5	Glands + ShroudsNo.2	EA	20		
6	Glands + ShroudsNo.3	EA	10		
7	Glands + ShroudsNo.5	EA	1		
8	CCG Boxes way no.1	EA	6		
9	80amp 6ka T/pole QF -3(26)-C2 Heinemann or equivalent and must be SABS/SANS approved	EA	5		
10	63Amp 6ka three phase earth leakage QF-N4(13) Heinemann or equivalent and must be SABS/SANS approved	EA	10		
11	63Amp 6ka single phase earth leakage QF-N-2 (13) Heinemann or equivalent and must be SABS/SANS approved	EA	5		

Item No	Description of Goods / Services	Unit of Measure	Quantity	Unit Price (ZAR)	Total Price (ZAR)
12	20Amp 6KA S/Pole MCB QF-1 Heinemann or equivalent and must be SABS/SANS approved	EA	10		
13	15Amp 6KA S/Pole MCB QF-1 Heinemann or equivalent and must be SABS/SANS approved	EA	10		
14	30Amp three phase contactor with 220V coil	EA	5		
15	4X2 extension boxes	EA	5		
16	95mm X 12mm lugs hole	EA	10		
17	PVC tape red, white, blue, green (Ten tolls per colour)	EA	50		
18	2.5mm X 2 core lead wire flex	M	100		
19	95mm ferrules	EA	10		
20	95mmX4core PVC/ECC cable	M	10		
21	Dura cast joint kit J5 or equivalent and must be SABS/SANS approved	EA	1		
22	25mmX4core PVC ECC Cable	M	190		
23	25mmX4core PVC ECC Cable	M	150		
24	2.5mmX2core PVC ECC	M	470		
25	Luminaire 1.5m anti-corrosive double tube IP65 light fittings complete with cool white lamps	EA	60		
26	16Amp industrial switched double sockets	EA	3		
27	63Amp 5 pin female welding plugs PVC AMPCO IP65 without earth leakage (Big Frame) or similar and must be SABS/SANS approved	EA	10		
28	400watt Beka projectolux HPS light fittings or equivalent and must be SABS/SANS approved	EA	7		
29	Supply action cricket kiosk number 01 complete with MCB Notes: Type: 3CR12 Thickness: 2mm Colour: Powder coated orange 40mic pre - wired terminals on the bottom of the kiosk lockable with pad locks Rating: IP65 MCB: CBI 6ka or equivalent Note: MCB must be clip-on type, not din rail Main MCB: 25ka All exposed wires to be covered with polycub covers Circuit breaker for kwh meter separate bucket Label of kiosk Drawing number ; 2115584 kiosk number 01	EA	1		

Item No	Description of Goods / Services	Unit of Measure	Quantity	Unit Price (ZAR)	Total Price (ZAR)
30	<p>Supply surface action cricket DB - boards number 01 to 05</p> <p>Notes: Type: 3CR12 - IP65 3x24 way DB board complete with door Thickness: 1.2mm Colour: Powder coated orange 40mic Legend card holder Lockable lever lock to take pad lock DB blank covers to be fitted mounting brackets for the DB board drawing number 1115584 kiosk number 01 to 05</p>	EA	5		

Notes to Pricing

- All Prices must be quoted in South African Rand, exclusive of VAT
- All items on the Pricing Schedule should be priced; if not it will result in a bid being disqualified.
- To facilitate like-for-like comparison bidders must submit pricing strictly in accordance with this price schedule and not utilise a different format. Deviation from this pricing schedule could result in a bid being disqualified.
- Please note that should you have offered a discounted price(s), Transnet will only consider such price discount(s) in the final evaluation stage if offered on an unconditional basis.
- Refer to Annexure C for the Specification of Goods for the low voltage cable and Infrastructure kiosks
- Refer to Annexure D for the drawings of the kiosk and distribution board

PREVIEW COPY ONLY

Section 3
VENDOR APPLICATION FORM

Respondents are to furnish the following documentation and complete the Vendor Application Form below:

1. **Original** cancelled cheque **OR** letter from the Respondent's bank verifying banking details [with bank stamp]
2. **Certified copy** of Identity Document(s) of Shareholders/Directors/Members [where applicable]
3. **Certified copies** of the relevant company registration documents from Companies and Intellectual Property Commission (CIPC)
4. **Certified copies** of the company's shareholding/director's portfolio
5. A letter on the company's letterhead confirm physical and postal addresses
6. **Original** valid SARS Tax Clearance Certificate
7. **Certified copy** of VAT Registration Certificate
8. **A valid and original B-BBEE Verification Certificate / sworn affidavit or certified copy** thereof meeting the requirements for B-BBEE compliance as per the B-BBEE Codes of Good Practice
9. **Certified copy** of valid Company Registration Certificate [if applicable]

Vendor Application Form

Company trading name							
Company registered name							
Company Registration Number or ID Number if a Sole Proprietor							
Form of entity [✓]	CC	Trust	Pty Ltd	Limited	Partnership	Sole Proprietor	
VAT number [if registered]							
Company telephone number							
Company fax number							
Company email address							
Company website address							
Bank name				Branch & Branch code			
Account holder				Bank account number			
Postal address							



Physical Address						Code
Contact person						Code
Designation						
Telephone						
Email						
Annual turnover range [last financial year]	< R5 m	R5 - 35 m	> R35 m			
Does your company provide	Products	Services	Both			
Area of delivery	National	Provincial	Local			
Is your company a public or private entity	Public		Private			
Does your company have a Tax Directive or IRP30 Certificate	Yes	No				
Main product or services (e.g. Stationery/Consulting)						

Complete B-BBEE Ownership Details:

% Black ownership	% Black women ownership	% Disabled Black ownership	% Youth ownership
Does your entity have a B-BBEE certificate	Yes	No	
What is your B-BBEE status [Level 1 to 9 / Unknown]			
How many personnel does the entity employ	Permanent	Part time	

If you are an existing Vendor with Transnet please complete the following:

Transnet contact person	
Contact number	
Transnet Operating Division	

Duly authorised to sign for and on behalf of Company / Organisation:

Name	Designation
Signature	Date

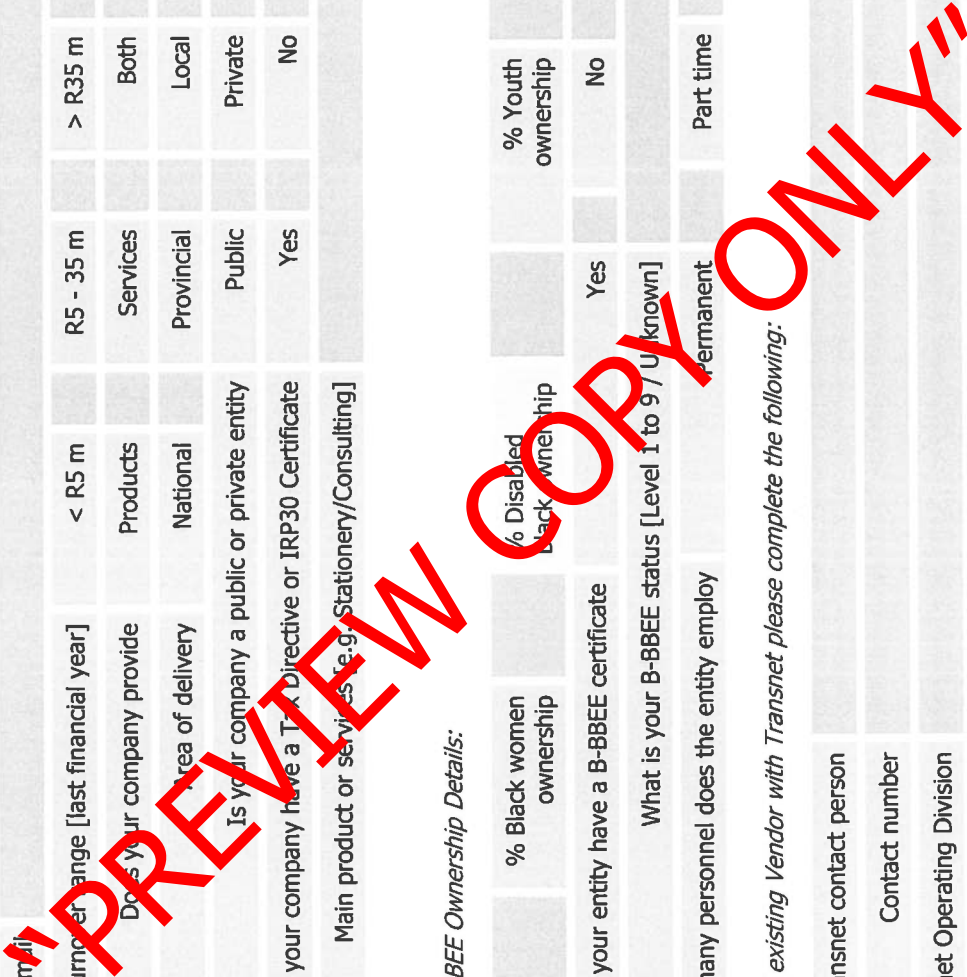

**RFQ FOR THE ONCE-OFF SUPPLY AND DELIVERY OF
VARIOUS ELECTRICAL MATERIALS INCLUDING A KIOSK AND DISTRIBUTION BOARD
TO RICHARDS BAY**

ANNEXURE A: B-BBEE PREFERENCE POINTS CLAIM FORM

This preference form contains general information and serves as a claim for preference points for Broad-Based Black Economic Empowerment [**B-BBEE**] Status Level of Contribution.

"PREVIEW COPY ONLY"

1. INTRODUCTION

- 1.1 A total of 20 preference points shall be awarded for B-BBEE Status Level of Contribution.
- 1.2 Failure on the part of a Bidder to fill in and/or to sign this form and submit a B-BBEE Verification Certificate from a Verification Agency accredited by the South African Accreditation System [**SANAS**] or a Registered Auditor approved by the Independent Regulatory Board of Auditors [**IRBA**] or an Accounting Officer as contemplated in the Close Corporation Act [**CCA**] together with the bid will be interpreted to mean that preference points for B-BBEE Status Level of Contribution are not claimed.

- 1.3 Transnet reserves the right to require of a Bidder, either before a Bid is adjudicated or at any time subsequently, to substantiate any claim in regard to preferences, in any manner required by Transnet.

2. GENERAL DEFINITIONS

- 2.1 **"all applicable taxes"** include value-added tax, pay as you earn, income tax, unemployment insurance fund contributions and skills development levies;
- 2.2 **"B-BBEE"** means broad-based black economic empowerment as defined in section 1 of the Broad-Based Black Economic Empowerment Act;
- 2.3 **"B-BBEE status of contributor"** means the B-BBEE status received by a measured entity, based on its overall performance using the relevant scorecard contained in the Codes of Good Practice on Black Economic Empowerment, issued in terms of section 9(1) of the Broad-Based Black Economic Empowerment Act;
- 2.4 **"Bid"** means a written offer in a prescribed or stipulated form in response to an invitation by Transnet for the provision of goods, works or services;
- 2.5 **"Broad-Based Black Economic Empowerment Act"** means the Broad-Based Black Economic Empowerment Act, 2003 [Act No. 53 of 2003];
- 2.6 **"comparative price"** means the price after the factors of a non-firm price and all unconditional discounts that can utilised have been taken into consideration;
- 2.7 **"consortium or joint venture"** means an association of persons for the purpose of combining their expertise, property, capital, efforts, skills and knowledge in an activity for the execution of a

Respondent's Signature

Date & Company Stamp

- contract;
- 2.8 **"contract"** means the agreement that results from the acceptance of a bid by Transnet;
- 2.9 **"EME"** means any enterprise with an annual total revenue of R5 [five] million or less as per the 2007 version of the B-BBEE Codes of Good Practice and means any enterprise with an annual total revenue of R10 [ten] million or less as per the Revised Codes of Good Practice issued on 11 October 2013 in terms of Government Gazette No. 36928;
- 2.10 **"firm price"** means the price that is only subject to adjustments in accordance with the actual increase or decrease resulting from the change, imposition, or abolition of customs and excise duty and any other duty, levy, or tax, which, in terms of the law or regulation, is binding on the contract and demonstrably has an influence on the price of any supplies, or the rendering costs of any services for the execution of the contract;
- 2.11 **"functionalit"** means the measurement according to predetermined norms, as set out in the bid documents, of a service or commodity that is designed to be practical and useful, working or operating, taking into account, among other factors, the quality, reliability, viability and durability of a service and the technical capacity and ability of a bidder;
- 2.12 **"non-firm prices"** means all prices other than "firm" prices;
- 2.13 **"person"** includes reference to a juristic person;
- 2.14 **"QSE"** means any enterprise with an annual total revenue between R5 [five] million and R35 [thirty five] million as per the 2007 version of the B-BBEE Codes of Good Practice and means any enterprise with an annual total revenue of between R10 [ten] million and R50 [fifty] million as per the Revised Codes of Good Practice issued on 11 October 2013 in terms of Government Gazette No. 36928
- 2.15 **"rand value"** means the total estimated value of a contract in South African currency, calculated at the time of bid invitations, and includes all applicable taxes and expense duties;
- 2.16 **"subcontract"** means the primary contractor's assigning or leasing, or making out work to, or employing another person to support such primary contractor in the execution of part of a project in terms of the contract;
- 2.17 **"total revenue"** bears the same meaning assigned to this expression in the Codes of Good Practice on Black Economic Empowerment, issued in terms of section 9(1) of the Broad-Based Black Empowerment Act and promulgated in the Government Gazette on 9 February 2007;
- 2.18 **"trust"** means the arrangement through which the property of one person is made over or bequeathed to a trustee to administer such property for the benefit of another person; and
- 2.19 **"trustee"** means any person, including the founder of a trust, to whom property is bequeathed in order for such property to be administered for the benefit of another person.

3. ADJUDICATION USING A POINT SYSTEM

- 3.1 The Bidder obtaining the highest number of total points for the evaluation criteria as enumerated in Section 2 of the RFP will be awarded the contract, unless objective criteria justifies the award to another bidder.

- 3.2 Preference points shall be calculated after prices have been brought to a comparative basis taking into account all factors of non-firm prices and all unconditional discounts.
- 3.3 Points scored will be rounded off to 2 [two] decimal places.
- 3.4 In the event of equal points scored, the Bid will be awarded to the Bidder scoring the highest number of preference points for B-BBEE.
- 3.5 However, when functionality is part of the evaluation process and two or more Bids have scored equal points including equal preference points for B-BBEE, the successful Bid will be the one scoring the highest score for functionality.
- 3.6 Should two or more Bids be equal in all respect, the award shall be decided by the drawing of lots.

4. POINTS AWARDED FOR B-BBEE STATUS LEVEL OF CONTRIBUTION

- 4.1 In terms of the Preferential Procurement Regulations, 2011, preference points shall be awarded to a Bidder for attaining the B-BBEE status level of contribution in accordance with the table below:

4.2

B-BBEE Status Level of Contributor	Number of Points [Maximum 20]
1	20
2	8
3	16
4	12
5	8
6	6
7	4
8	2
Non-compliant contributor	0

- 4.3 Bidders who qualify as EMEs in terms of the 2007 version of the Codes of Good Practice must submit a certificate issued by an Accounting Officer as contemplated in the CCA or a Verification Agency accredited by SANAS or a Registered Auditor. Registered auditors do not need to meet the prerequisite for IRBA's approval for the purpose of conducting verification and issuing EME's with B-BBEE Status Level Certificates.
- 4.4 Bidders who qualify as EMEs in terms of the Revised Codes of Good Practice issued on 11 October 2013 in terms of Government Gazette No. 36928 are only required to obtain a sworn affidavit on an annual basis confirming that the entity has an Annual Total Revenue of R10 million or less and the entity's Level of Black ownership.
- 4.5 In terms of the 2007 version of the Codes of Good Practice, Bidders other than EMEs must submit their original and valid B-BBEE status level verification certificate or a certified copy thereof, substantiating their B-BBEE rating issued by a Registered Auditor approved by IRBA or a Verification Agency accredited by SANAS.

- 4.6 In terms of the Revised Codes of Good Practice issued on 11 October 2013 in terms of Government Gazette No. 36928, Bidders who qualify as QSEs are only required to obtain a sworn affidavit on an annual basis confirming that the entity has an Annual Total Revenue of R50 million or less and the entity's Level of Black ownership. Large enterprises must submit their original and valid B-BBEE status level verification certificate or a certified copy thereof, substantiating their B-BBEE rating issued by a Registered Auditor approved by IRBA or a Verification Agency accredited by SANAS.
- 4.7 A trust, consortium or joint venture will qualify for points for its B-BBEE status level as a legal entity, provided that the entity submits its B-BBEE status level certificate.
- 4.8 A trust, consortium or joint venture will qualify for points for their B-BBEE status level as an unincorporated entity, provided that the entity submits their consolidated B-BBEE scorecard as if they were a separate legal entity, and that such a consolidated B-BBEE scorecard is prepared for every separate bid.
- 4.9 Tertiary institutions and public entities will be required to submit their B-BBEE status level certificates in terms of the specialised scorecard contained in the B-BBEE Codes of Good Practice.
- 4.10 A person will not be awarded points for B-BBEE status level if it is indicated in the Bid documents that such a Bidder intends subcontracting more than 25% [twenty-five per cent] of the value of the contract to any other enterprise that does not qualify for at least the same number of points that such a Bidder qualifies for, unless the intended subcontractor is an EME that has the capability and ability to execute the subcontract.
- 4.11 A person awarded a contract may not subcontract more than 25% [twenty-five per cent] of the value of the contract to any other enterprise that does not have an equal or higher B-BBEE status level than the person concerned, unless the contract is subcontracted to an EME that has the capability and ability to execute the subcontract.
- 4.12 Bidders are to note that in terms of paragraph 2.6 of Statement 000 of the Revised Codes of Good Practice issued on 11 October 2013 in terms of Government Gazette No. 36928, any representation made by an entity about its B-BBEE compliance must be supported by suitable evidence or documentation. As such, Transnet reserves the right to request such evidence or documentation from Bidders in order to verify any B-BBEE recognition claimed.

5. B-BBEE STATUS AND SUBCONTRACTING

- 5.1 **Bidders who claim points in respect of B-BBEE Status Level of Contribution must complete the following:**

B-BBEE Status Level of Contributor _____ = _____ [maximum of 20 points]

Note: Points claimed in respect of this paragraph 5.1 must be in accordance with the table reflected in paragraph 4.1 above and must be substantiated by means of a B-BBEE certificate issued by a Verification Agency accredited by SANAS or a Registered Auditor approved by IRBA or a sworn affidavit in the case of an EME or QSE.

5.2 **Subcontracting:**

Will any portion of the contract be subcontracted? YES/NO [delete which is not applicable]

If YES, indicate:

- (i) What percentage of the contract will be subcontracted?%
- (ii) The name of the subcontractor
- (iii) The B-BBEE status level of the subcontractor
- (iv) Is the subcontractor an EME? YES/NO

5.3 Declaration with regard to Company/Firm

- (i) Name of Company/Firm.....
- (ii) VAT registration number.....
- (iii) Company registration number.....
- (iv) Type of Company / Firm [TICK APPLICABLE BOX]
 - Partnerships/Joint Venture/Consortium
 - One person business/sole propriety
 - Close Corporation
 - Company (Pty) Ltd
- (v) Describe Principal Business Activities
.....
.....
.....
- (vi) Company Classification [TICK APPLICABLE BOX]
 - Manufacturer
 - Supplier
 - Professional Service Provider
 - Other Service Providers, e.g Transporter, etc
- (vii) Total number of years the company/firm has been in business.....

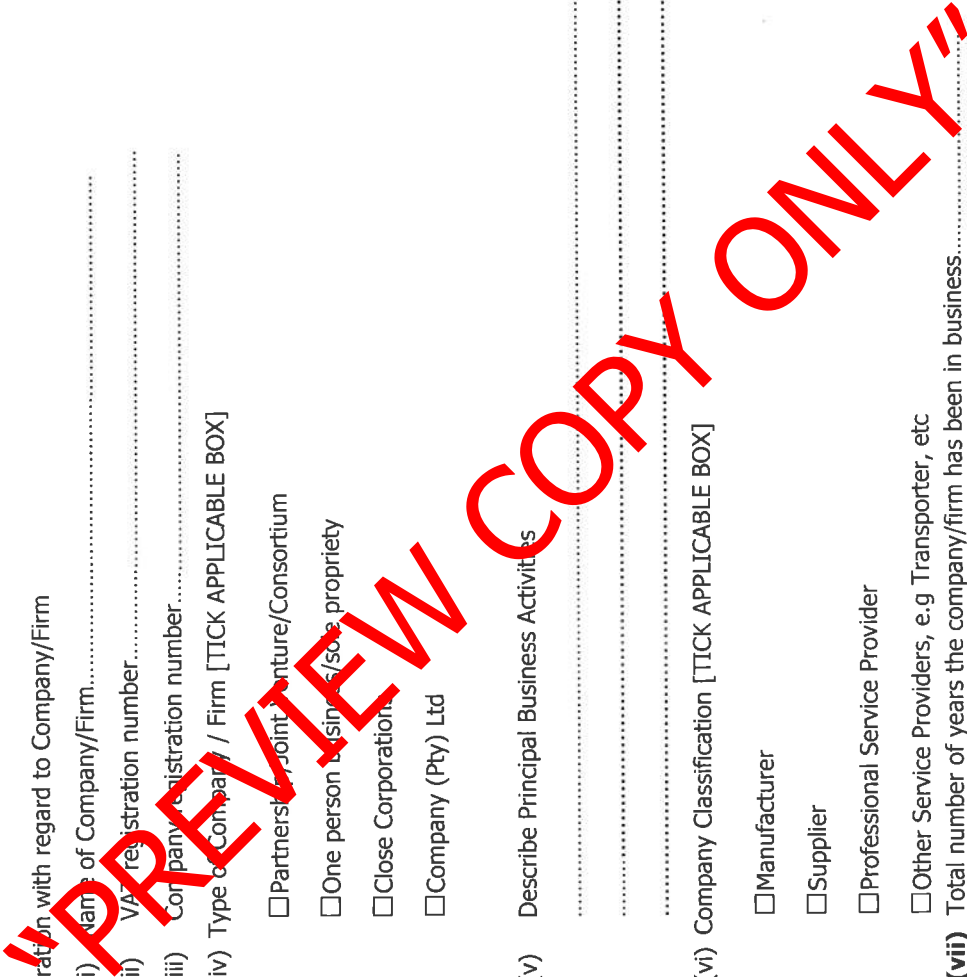

BID DECLARATION

I/we, the undersigned, who warrants that he/she is duly authorised to do so on behalf of the company/firm, certify that points claimed, based on the B-BBEE status level of contribution indicated in paragraph 4 above, qualifies the company/firm for the preference(s) shown and I / we acknowledge that:

- (i) The information furnished is true and correct.
- (ii) In the event of a contract being awarded as a result of points claimed as shown in paragraph 6 above, the contractor may be required to furnish documentary proof to the satisfaction of Transnet that the claims are correct.
- (iii) If the B-BBEE status level of contribution has been claimed or obtained on a fraudulent basis or any of the conditions of contract have not been fulfilled, Transnet may, in

Respondent's Signature

Date & Company Stamp

addition to any other remedy it may have:

- (a) disqualify the person from the bidding process;
- (b) recover costs, losses or damages it has incurred or suffered as a result of that person's conduct;
- (c) cancel the contract and claim any damages which it has suffered as a result of having to make less favourable arrangements due to such cancellation;
- (d) restrict the Bidder or contractor, its shareholders and directors, and/or associated entities, or only the shareholders and directors who acted in a fraudulent manner, from obtaining business from Transnet for a period not exceeding 10 years, after the *audi alteram partem* [hear the other side] rule has been applied; and/or forward the matter for criminal prosecution.

WITNESSES

SIGNATURE OF BIDDER

1.
2.

DATE:

COMPANY NAME:

ADDRESS:

"PREVIEW COPY ONLY"

Respondent's Signature

Date & Company Stamp

ANNEXURE B: TECHNICAL/FUNTIONALITY CRITERIA

Criteria	Sub-Criteria	To be submitted
Compliance to specifications	Brands and SABS/SANS code offered	Complete Annexure B1
	Type Testing of Kiosk	Refer to Annexure B2
Criteria	Sub-Criteria	Lead-times offered
Delivery Lead time	Lead time from date of award of an official purchase order to delivery of the goods (Items 1 to 27 & 30 on the Quotation form)	Complete Annexure B3
	Lead time from date of award of an official purchase order to delivery of the vent fittings (Item 28 on the Quotation form)	
	Lead time from date of award of an official purchase order to delivery of the kiosk (Item 29 on the Quotation form)	
Criteria	Sub-Criteria	Company's geographical position
Regional footprint	Geographical Position	Complete Annexure B4

"PREVIEW COPY ONLY"

Respondent's Signature

Date & Company Stamp

ANNEXURE B1: BRANDS AND SABS/SANS CODES OFFERED

Item No	Description of Goods /Services	SABS/SANS code of goods offered	
1	PT12-76 wideX3m long light duty cable trays		
2	PT19-101 wideX3m long light duty cable trays		
3	T50I PVC ties		
4	Glands + ShroudsNo.1		
5	Glands + ShroudsNo.2		
6	Glands + ShroudsNo.3		
7	Glands + ShroudsNo.4		
8	CCG Boxes way no.1		
Item No	Description of Goods /Services	Brand offered	SABS/SANS code of brand offered
9	80amp 6ka T/pole QF -3(26) C2 Heinemann or equivalent and must be SABS/SANS approved		
10	63Amp 6ka three phase earth leakage QF-N-2 (10) Heinemann or equivalent and must be SABS/SANS approved		
11	63Amp 6ka single phase earth leakage QF-N-2 (10) Heinemann or equivalent and must be SABS/SANS approved		
12	20Amp 6KA S/Pole MCB QF-1 Heinemann or equivalent and must be SABS/SANS approved		
13	15Amp 6KA S/Pole MCB QF-1 Heinemann or equivalent and must be SABS/SANS approved		
Item No	Description of Goods /Services	SABS/SANS code of goods offered	
14	30Amp three phase contactor with 220Volt coil		
15	4X2 extension boxes		
16	95mm X 12mm lugs hole		
17	PVC tape red, white, blue, green (Ten tolls per colour)		
18	2.5mm X 2core+earth surflex		
19	95mm ferrules		
20	95mmX4core PVC/ECC cable		
Item No	Description of Goods /Services	Brand offered	SABS/SANS code of brand offered
21	Dura cast joint kit J5 or equivalent and must be SABS/SANS approved		
Item No	Description of Goods /Services	SABS/SANS code of goods offered	
22	25mmX4core PVC ECC Cable		
23	25mmX4core PVC ECC Cable		
24	2.5mmX2core PVC ECC		

Item No	Description of Goods /Services	SABS/SANS code of goods offered	
25	Luminaire 1.5m anti-corrosive double tube IP65 light fittings complete with cool white lamps		
26	16Amp industrial switched double sockets		
Item No	Description of Goods /Services	Brand offered	SABS/SANS code of brand offered
27	63Amp 5 pin female welding plugs PVC AMPCO IP65 without earth leakage (Big Frame) or similar and must be SABS/SANS approved		
28	400watt Beka protectolux HPS light fittings or equivalent and must be SABS/SANS approved		
Item No	Description of Goods /Services	Brand offered (MCB)	SABS/SANS code of brand offered
29	<p>Supply action cricket kiosk number 01 complete with MCB</p> <p>Notes: Type: 3CR12 Thickness: 2mm Colour: Powder coated orange 40mic pre - wired terminals on the bottom of the kiosk lockable with pad locks Rating: IP65 MCB: CBI 6ka or equivalent Note: MCB must be clip-on type, not din rail Main MCB: 25ka All exposed wires to be covered with polycub covers Circuit breaker for kwh meter separate bucket Label of kiosk Drawing number ; 2115584 kiosk number 01</p>		

PREVIEW COPY ONLY

ANNEXURE B2: TYPE TESTING OF BOARDS AND BUSBARS

The kiosk must be manufactured in accordance with the requirements as laid down in the SANS 1973-3 or SANS 1765 amdt1; amdt 2; amdt 3 code of practice for type tested boards fit for purpose. The bus bars will be correctly sized (SANS 60439-1/IEC 60439-1) in order to accommodate the loading of the breakers and be correctly support, rated and spaced to meet the requirements of the loading

Documentation to be submitted by your company:

A letter of your company or your manufacturer certifying/guaranteeing that you can manufacture type tested boards as laid down by the SANS code of practice and that the bus bars will be correctly sized as per SANS 60439-1/IEC 60439-1



Respondent's Signature

Date & Company Stamp

ANNEXURE B3: DELIVERY LEAD TIME

Item No	Description of Goods / Services	Unit of Measure	Quantity	Lead-time
1	PT12-76 wideX3m long light duty cable trays	M	30	
2	PT19-101 wideX3m long light duty cable trays	M	30	
3	T501 PVC ties	EA	8	
4	Glands + ShroudsNo.1	EA	120	
5	Glands + ShroudsNo.2	EA	20	
6	Glands + ShroudsNo.3	EA	10	
7	Glands + ShroudsNo.5	EA	1	
8	CCG Boxes with no	EA	6	
9	80amp 6ka T/pole (QF-1-26)-C2 Heinemann or equivalent and must be SABS/SANS approved	EA	5	
10	63Amp 6ka three phase earth leakage package QF-N4(13) Heinemann or equivalent and must be SABS/SANS approved	EA	10	
11	63Amp 6ka single phase earth leakage QF-N-2 (13) Heinemann or equivalent and must be SABS/SANS approved	EA	5	
12	20Amp 6KA S/Pole MCB QF-1 Heinemann or equivalent and must be SABS/SANS approved	EA	10	
13	15Amp 6KA S/Pole MCB QF-1 Heinemann or equivalent and must be SABS/SANS approved	EA	10	
14	30Amp three phase contactor with 220Volt coil	EA	5	
15	4X2 extension boxes	EA	5	
16	95mm X 12mm lugs hole	EA	10	
17	PVC tape red, white, blue, green (Ten tollis per colour)	EA	50	
18	2.5mm X 2core+earth surflex	M	190	
19	95mm ferrules	EA	10	
20	95mmX4core PVC/ECC cable	M	10	
21	Dura cast joint kit J5 or equivalent and must be SABS/SANS approved	EA	1	
22	25mmX4core PVC ECC Cable	M	190	
23	25mmX4core PVC ECC Cable	M	150	
24	2.5mmX2core PVC ECC	M	470	
25	Luminaire 1.5m anti-corrosive double tube IP65 light fittings complete with cool white lamps	EA	60	
26	16Amp industrial switched double sockets	EA	30	
27	63Amp 5 pin female welding plugs PVC AMPCO IP65 without earth leakage (Big Frame) or similar and must be SABS/SANS approved	EA	10	

Item No	Description of Goods / Services	Unit of Measure	Quantity	Lead-time
30	Supply surface action cricket DB - boards number 01 to 05 Notes: Type: 3CR12 - IP65 3x24 way DB board complete with door Thickness: 1.2mm Colour: Powder coated orange 40mic Legend card holder Lockable lever lock to take pad lock DB blank covers to be fitted mounting brackets for the DB board drawing number 2115584 kiosk number 01 to 05	EA	5	
28	400watt Beka project box MBS light fittings or equivalent and must be SABS/SANS approved	EA	7	
29	Supply action cricket kiosk number 01 complete with MCB Notes: Type: 3CR12 Thickness: 2mm Colour: Powder coated orange 40mic pre - wired terminals on the bottom of the kiosk lockable with pad locks Rating: IP65 MCB: CBI 6ka or equivalent Note: MCB must be clip-on type, not din rail Main MCB: 25ka All exposed wires to be covered with polycub covers Circuit breaker for kwh meter separate bucket Label of kiosk Drawing number ; 2115584 kiosk number 01	EA	1	

PREVIEW COPY ONLY

ANNEXURE B4: REGIONAL FOOTPRINT

Please provide your company's geographical position:

"PREVIEW COPY ONLY"

Note: Attach your company's municipal bill to this annexure as proof of your physical address provided above.

Respondent's Signature

Date & Company Stamp

ANNEXURE C: SPECIFICATION OF GOODS

LOW VOLTAGE CABLES

The low voltage cable to be supplied is to be used in the connections of electrical kiosks. The low voltage cables shall be stranded copper conductor, with P.V.C/ E.C.C insulated and armour wiring. This cable shall comply with S.A.B.S 1507.

The various sizes of low voltage P.V.C/E.C.C insulated stranded copper cables to be used in this project will come with proof of a test certification that the cables have been tested prior to leaving the factory in accordance with S.A.B.S. The price for the transportation to site in Richards Bay and the offloading of the cables at site must be worked into the price.

KIOSKS

The kiosks will be manufactured in accordance with the requirements as laid down in the SANS 1973-3 or SANS 1765 amdt1; amdt 2; and 3. The practice for type tested boards fit for purpose. The bus bars will be correctly sized (SANS 60439-1 IEC 60439-1) in order to accommodate the loading of the breakers and be correctly support, rated and spaced to meet the requirements of the loading.

The board will come with cover plates to prevent access to the electrical components housed behind them and the cover plate will be sufficiently supported in the panel to prevent access to these components. The kiosk is floor standing and shall have an overall height of 65 with the structure of the kiosk being manufactured out of 1.6mm thick 3CR12 stainless steel, the kiosk is to be powder coated with 40 micron Electrical Orange paint. The switchgear shall be of the same or equivalent and the kiosk is to be entered from the bottom. The kiosk is to come with a separate earth and neutral bar and the doors are to be fitted with swivel handles that can be locked with a padlock. There must be labeling under each breaker with the provision for an inventory card on the inside of the door behind a plastic cover, all switch-disconnectors are to be suitable labeled and must comply with SANS 10142-1:2003 (6.8.1 and 6.9.4). The front door and rear door must be fitted with the name of the kiosk and the voltage as well as a lightning sign indicating danger. There must be provision made for 20% space in the board for future expansion and there must be pre-wired terminal blocks at the bottom of the board for the incoming cables to terminate onto. All components installed in the kiosk must be SABS approved and recognized in the market.

400W FLOODLIGHT

400W Metal halide floodlight luminaire complete with tubular lamp and stainless steel helicoils This specification is to be strictly adhered to.

The luminaire shall consist of both a high pressure die cast aluminum and stainless steel lamp housing with a separate but attached control gearbox and shall be designed to operate 400 Watt Tubular Metal Halide lamp.

The luminaire shall bear the **SANS 60598-2-5 mark and the SANS 475 mark.**

The luminaire shall have a degree of protection that complies with **SANS 60598:**

Lamp compartment: IP65

Control gear compartment: IP65

The IP rating shall be certified by a SABS test report.

The lamp housing shall consist of two high pressure die cast aluminum side plates that control the shape of the pre-formed back reflectors by four extruded aluminum stay bars. The front glass shall be

heat and impact resistant, held to the lamp housing by at least four stainless steel clamps and sealed by molded heat resistant silicon sponge gasket.

The reflector system shall be manufactured from 99,98% super-pure anodized aluminum and shall consist of the back reflector and two side reflectors. The luminaire shall be in a medium beam distribution. It shall only have a symmetrical reflector and beam distributions.

Lamp replacement shall be facilitated from the side by a high-pressure die cast aluminum lamp holder housing. It shall be sealed with a one-piece silicon gasket and shall be held to the floodlight with two stainless steel screws. The 2 finger grips on the lamp holder housing shall be able to be used for visual aiming.

The control gear compartment shall be manufactured from LM6 high-pressure die-cast aluminum for good heat dissipation. It shall consist of a lid and body that shall seal the control gear compartment with four stainless steel screws into helicoils to an IP65 ingress protection rating when closed. The lid shall be held captive by a removable wish-bone spring when opened. The control gear box may not be within the body of the luminaire.

The lamp holder complies with VDE 0611, shall be rated to withstand 240°C/5kV and shall prevent loosening of the lamp caused by vibrations. The control gear shall be incorporated inside the control gear compartment and shall be mounted on a removable gear tray. It shall be suitable for operation with the specified rating of the lamp on 230V \pm 3%/-10% 50Hz single phase system. All control gear components shall be removable and shall bear the relevant SABS mark. All internal wiring shall be Teflon coated with protective sleeving to prevent damage by possible abrasion. All screws, bolts and metal parts shall be stainless steel or non-corrosive material. Mains connections shall be by means of a suitable screw terminal block with a wire clamping contact. Igniters, where applicable, shall be of the superposed pulse type. The luminaire shall be powder coated or electroplated to a minimum of 0,90.

The Wire between lamp compartment and control gear shall be Teflon coated with an extra thick **insulated live wire**.

The stirrup shall be manufactured from 5 x 40mm hot dipped galvanized steel. Holes shall be provided for mounting purposes.

The following dimensions must be adhered to:

Luminaire dimensions - Width 400 x Length 390 x depth 360

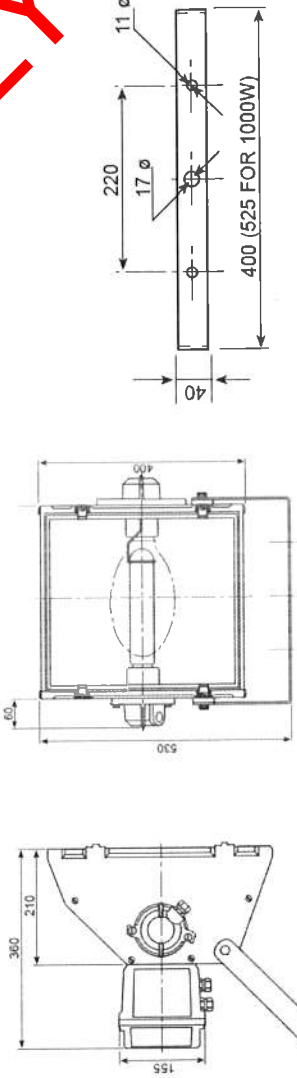

ANNEXURE D – DRAWING

Drawing listed as mentioned in Section 2: Quotation Form

Item number	Description of Goods / Services	Drawing reference
1	<p>Supply action cricket kiosk number 01 complete with MCB</p> <p>Notes: Type: 3CR12 Thickness: 2mm Colour: Powder coated orange Terminals - wired terminals on the back of the kiosk Lockable with pad locks Rating: 25 MCB: C31 6ka Main MCB: 25ka All exposed wires to be covered with polycub covers Circuit breaker for kWh meter separate bucket Label of kiosk</p>	<ul style="list-style-type: none"> 2115584 Action Cricket Kiosk



1. TYPE-3CR12 KIOSK
2. THICKNESS-2MM
3. COLOUR- POWDER COATE ORANGE
4. PRE- WIRED TERMINALS ON BOTTOM OF KIOSK
5. LOCKABLE WITH PAD LOCK
6. RATING- IP65
7. MCB- CBI 6KA
8. MAINS MCB- CBI 25KA
9. ALL EXPOSED WIRES TO BE COVERED WITH POLYCARB COVERS
10. CIRCUIT BREAKER FOR KWH METER, SEPERATE BUCKET

NOTES

ACTION CRICKET KIOSK

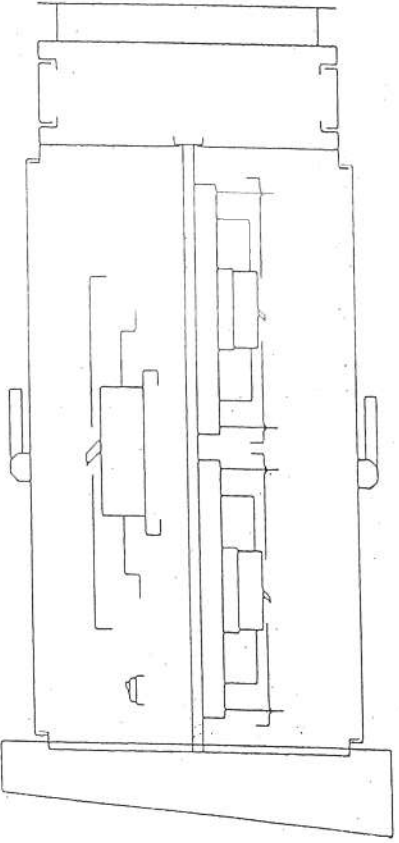

SIDE VIEW

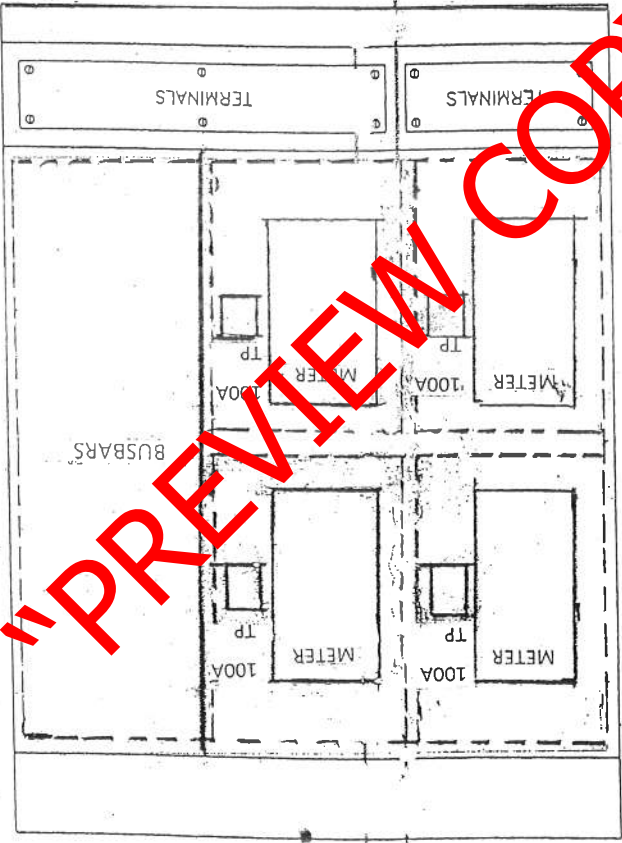

REAR VIEW

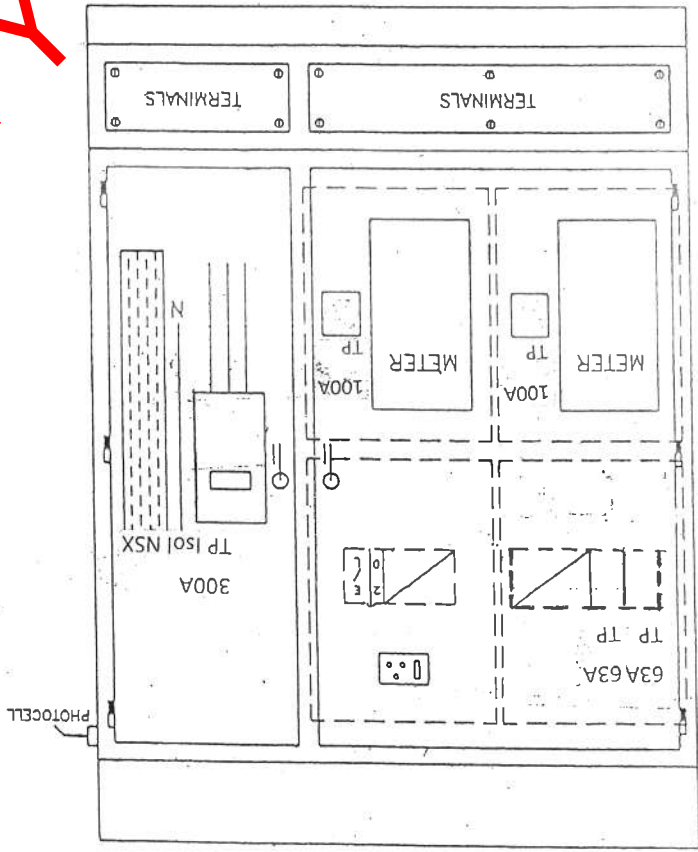

FRONT VIEW



"PREVIEW COPY ONLY"

Item number	Description of Goods / Services	Drawing reference
2	<p>Supply surface action cricket DB - boards number 01 to 05</p> <p>Notes: Type: 3CR12 - IP65 3x24 way DB board complete with door Thickness: 1.2mm Colour: Powder coated orange 40mic Legend card holder Lockable lever lock to take pad lock DB blank covers to be fitted mounting breakers for the DB board</p>	<ul style="list-style-type: none"> 2115584-01 Action Cricket DB-Board

"PREVIEW COPY ONLY"

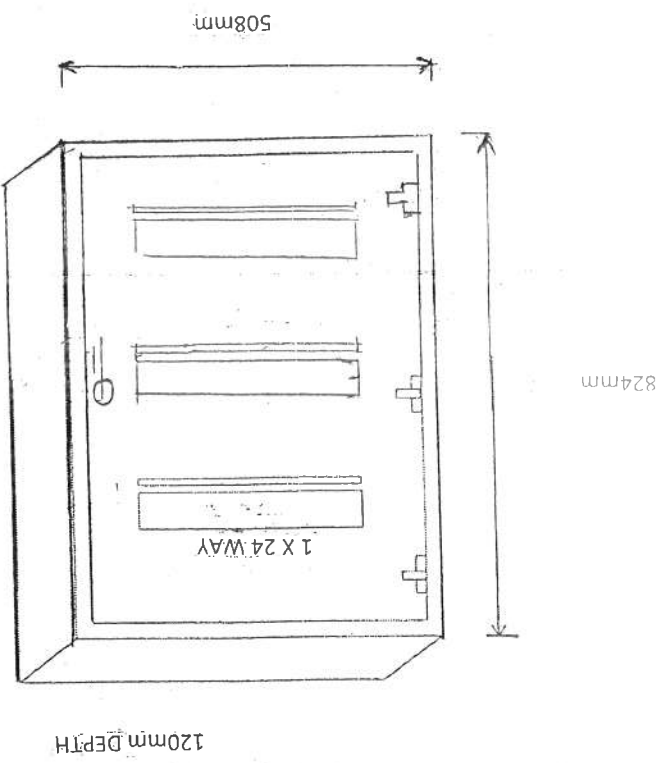

- 1 TYPE 3CR12 DB-BOARD
- 2 THICKNESS - 1.2MM
- 3 COLOUR - POWER COATED ORANGE
- 4 LEGEND CARD HOLDER, PVC NO STRIPS
- 5 TEE HIGES
- 6 LOCKABLE LEVER LOCK
- 7 DB-BOARD BLANK COVERS TO BE FITTED
- 8 MOUNTING - BREAKETS FOR DB BOARD
- 9 DB-BOARD - TO TAKE CBI MCB

DRAWING NUMBER: 2115584-01

"PREVIEW COPY ONLY"

TYPE	MATERIAL	THICKNESS
FLUSH	IP65	1.2 MM
SURFACE	IP65	1.6 MM
FLOOR	3CR12	2.0 MM
INDOOR	DOOR	FACE PLATE
OUTDOOR	DOOR	FACE PLATE
COLOUR	ORANGE	FINISH
BOARD	ORANGE	EPOXY
DOOR	ORANGE	EPOXY
INNER COVER	WHITE	EPOXY

EQUIPMENT	M.C.B.	C.B.I	URGENCE ARREST
CONTACTOR			
ISOLATOR			
TEMP SWITGH			

NOTES

**RFQ FOR THE ONCE-OFF SUPPLY AND DELIVERY OF
VARIOUS ELECTRICAL MATERIALS INCLUDING A KIOSK AND DISTRIBUTION BOARD
TO RICHARDS BAY**

ANNEXURE E: CERTIFICATE OF ATTENDANCE OF RFQ BRIEFING

It is hereby certified that –

- 1. _____
- 2. _____

Representative(s) of _____ *[name of entity]*
attended the RFQ briefing in respect of the proposed Goods to be supplied in terms of this RFQ on 11th of
November 2014 at 11:00.

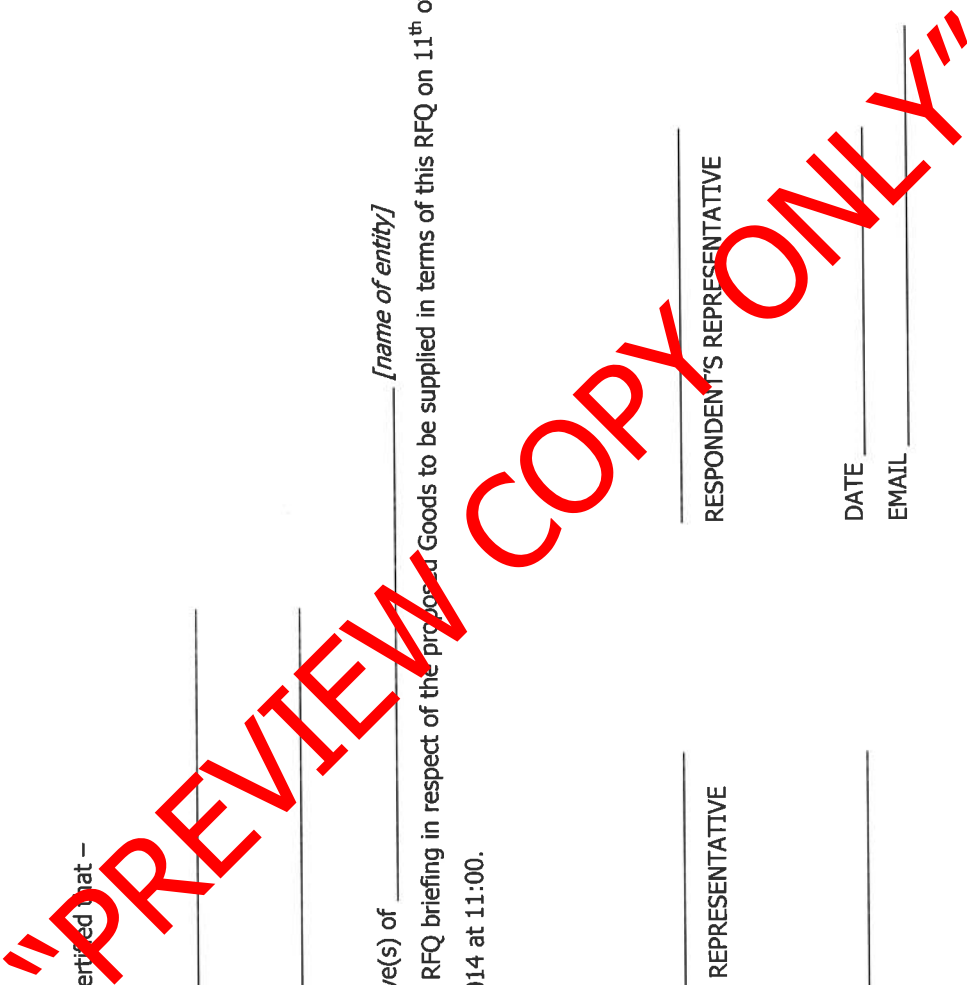

TRANSNET'S REPRESENTATIVE

RESPONDENT'S REPRESENTATIVE

DATE _____

DATE _____

EMAIL _____

EMAIL _____

Respondent's Signature

Date & Company Stamp