



TRANSNET FREIGHT RAIL RME, a division of

TRANSNET SOC LTD

Registration Number 1990/000900/30

[hereinafter referred to as **Transnet**]

REQUEST FOR QUOTATION [RFQ] No RME RBY 086/2014

FOR THE PROVISION OF SUPPLY & DELIVER, VARIOUS SIZES STAINLESS STEEL FASTENERS, ON AN "AS & WHEN" BASIS, FOR A 24 MONTH PERIOD.

FOR DELIVERY TO: TRANSNET FREIGHT RAIL (RME), 1 MORRIS ROAD, EMPANGENI RAIL, OLD GOODS SHED, OHTE STORE.

ISSUE DATE: 12 to 19 November 2014

CLOSING DATE: 20 November 2014

CLOSING TIME: 10:00

"PREVIEW COPY ONLY"

Section 1
NOTICE TO BIDDERS

Quotations which must be completed as indicated in Section 2 of this RFQ are to be submitted as follows:

METHOD:	Tender box submissions only ! (Complete documents, with all supporting documents)
CLOSING VENUE:	Transnet Freight Rail (RME), The Chairman of the Acquisition Council, Inyanda House 1, 21 Wellington Road, Parktown, Gauteng.
PROOF OF SUBMISSION:	Please fax /e-mail your "PROOF" (Fax Receipt or E-Mail Proof) with first page of tender document that is stamped with company detail to, 086 515 9978/or TCPtendersRichardsBay@Transnet.net as proof/confirmation that your have submitted a quotation.

1 Responses to RFQ

Responses to this RFQ [**Quotations**] must not include documents or reference relating to any other quotation or proposal. Any additional conditions must be embodied in an accompanying letter.

2 Broad-Based Black Economic Empowerment [B-BBEE]

Transnet fully endorses and supports the Government's Broad-Based Black Economic Empowerment Programme and it would therefore prefer to do business with local business enterprises who share these same values. Transnet will accordingly allow a "preference" to companies who provide a valid B-BBEE Verification Certificate. All procurement transactions will be evaluated accordingly.

2.1 B-BBEE Scorecard and Rating

As prescribed in terms of the Preferential Procurement Policy Framework Act (PPPFA), Act 5 of 2000 and its Regulations, Respondents are to note that the following preference point systems are applicable to all bids:

- the 80/20 system for requirements with a Rand value of up to R1 000 000 (all applicable taxes included); and
- the 90/10 system for requirements with a Rand value above R1 000 000 (all applicable taxes included).
- Bidders are to note that if the 80/20 preference point system is stipulated in this RFP and all Bids received exceed R1 000 000.00, the RFP must be cancelled. Similarly, if the 90/10 preference point system is stipulated in this RFP and all Bids received are equal to or below R1 000 000.00, the RFP must be cancelled.

The value of this bid is estimated to exceed R1 000 000 (all applicable taxes included); and therefore the **90/10** system shall be applicable.

When Transnet invites prospective suppliers to submit Proposals for its various expenditure programmes, it requires Respondents to have their B-BBEE status verified in compliance with the

Codes of Good Practice issued in terms of the Broad Based Black Economic Empowerment Act No. 53 of 2003.

The Department of Trade and Industry recently revised the Codes of Good Practice on 11 October 2013 [Government Gazette No. 36928]. The Revised Codes will replace the Black Economic Empowerment Codes of Good Practice issued on 9 February 2007. The Revised Codes provide for a one year transitional period starting 11 October 2013. During the transitional period, companies may elect to be measured in terms of the Revised Codes or the 2007 version of the Codes. After the first year of the implementation of the Revised Codes, B-BBEE compliance will be measured in terms of the Revised Codes without any discretion. Companies which are governed by Sector-specific Codes will be measured in terms of those Sector Codes.

As such, Transnet will accept B-BBEE certificates issued based on the Revised Codes. Transnet will also continue to accept B-BBEE certificates issued in terms of the 2007 version of the Codes provided it was issued before 10 October 2014. Thereafter, Transnet will only accept B-BBEE certificates issued based on the Revised Codes.

Respondents are required to complete Annexure A [the B-BBEE Preference Point Claim Form] and submit it together with proof of their B-BBEE Status as stipulated in the Claim Form in order to obtain preference points for their B-BBEE status.

Note: Failure to submit a valid and original B-BBEE certificate or a certified copy thereof at the Closing Date of this RFQ will result in a score of zero being allocated for B-BBEE.

[Refer clause 0 below for Returnable Documents required]

2.2 B-BBEE Improvement Plan

B-BBEE Improvement Plan will not be required for this tender.

2.3 Supplier Development Initiatives

Supplier Development will not apply to this tender.

3 Communication

Respondents are warned that a response will be liable for disqualification should any attempt be made by a Respondent either directly or indirectly to canvass any officer(s) or employee of Transnet in respect of this RFQ between the closing date and the date of the award of the business.

A Respondent may, however, before the closing date and time, direct any written enquiries relating to the RFQ to the following Transnet employee:

Name: Eddie Quinn
Email: eddie.quinn@transnet.net

Respondents may also, at any time after the closing date of the RFQ, communicate with the Regional Supply Chain Manager of the Supply Chain Department on any matter relating to its RFQ response:

Telephone 035 905 4609
Email Lizelle.smith@transnet.net

4 Tax Clearance

The Respondent's original and valid Tax Clearance Certificate must accompany the Quotation. Note that no business shall be awarded to any Respondent whose tax matters have not been declared by SARS to be in order.

5 VAT Registration

The valid VAT registration number must be stated here: _____ [if applicable].

6 Legal Compliance

The successful Respondent shall be in full and complete compliance with any and all applicable national and local laws and regulations.

7 Changes to Quotations

Changes by the Respondent to its submission will not be considered after the closing date and time.

8 Pricing

All prices must be quoted in South African Rand on a fixed price basis, excluding VAT.

9 Prices Subject to Confirmation

Prices quoted which are subject to confirmation will not be considered.

10 Negotiations

Transnet reserves the right to undertake post-tender negotiations with selected Respondents or any number of shortlisted Respondents.

11 Binding Offer

Any Quotation furnished pursuant to this Request shall be deemed to be an offer. Any exceptions to this statement must be clearly and specifically indicated.

12 Discrimination

Transnet is not committed to any course of action as a result of its issuance of this RFQ and/or its receipt of a Quotation in response to it. Please note that Transnet reserves the right to:

- modify the RFQ's goods / service(s) and request Respondents to re-bid on any changes;
- reject any Quotation which does not conform to instructions and specifications which are detailed herein;
- disqualify Quotations submitted after the stated submission deadline;
- not necessarily accept the lowest priced Quotation;
- reject all Quotations, if it so decides;
- place an order in connection with this Quotation at any time after the RFQ's closing date;
- award only a portion of the proposed goods / service/s which are reflected in the scope of this RFQ;
- split the award of the order/s between more than one Supplier/Service Provider; or
- make no award at all.

Transnet reserves the right to award business to the highest scoring bidder/s unless objective criteria justify the award to another bidder.

13 Transnet’s supplier integrity pact

Transnet’s Integrity Pact requires a commitment from suppliers and Transnet that they will not engage in any corrupt and fraudulent practices, anti-competitive practices; and act in bad faith towards each other. The Integrity Pact also serves to communicate Transnet’s Gift Policy as well as the remedies available to Transnet where a Respondent contravenes any provision of the Integrity Pact.

Respondents are required to familiarise themselves with the contents of the Integrity Pact which is available on the Transnet Internet site [www.transnet.net/Tenders/Pages/default.aspx] or on request. Furthermore, Respondents are required to certify that they have acquainted themselves with all the documentation comprising the Transnet Integrity Pact and that they fully comply with all the terms and conditions stipulated in the Transnet Supplier Integrity Pact as follows:

YES		NO	
------------	--	-----------	--

Should a Respondent need to declare previous transgressions or a serious breach of law in the preceding 5 years as required by Annexure A to the Integrity Pact, such declaration must accompany the Respondent’s bid submission.

14 Respondent’s Samples

Respondent’s samples will not be required for this tender.

15 Evaluation Criteria

Transnet will utilise the following criteria [not necessarily in this order] in choosing a Supplier/Service Provider, if so required:

Criterion/Criteria	Explanation
Administrative responsiveness	Completeness of response and returnable documents
Substantive responsiveness	Prequalification criteria, if any, must be met and whether the Bid materially complies with the scope and/or specification given. <ul style="list-style-type: none"> All items on the Pricing Schedule should be priced; if not it will result in a bid being disqualified. (All 52 Items.)
Functionality Threshold	As prescribed in terms of the Preferential Procurement Policy Framework Act (PPFA), Act 5 of 2000 and its Regulations, Respondents are to note that functionality is included as threshold with a prescribed percentage threshold of 60%. Delivery lead-time, Regional footprint.

<p>Final weighted evaluation based on 90/10 preference point system as indicated in paragraph 2</p>	<ul style="list-style-type: none"> • Pricing and price basis [firm] - whilst not the sole factor for consideration, competitive pricing and overall level of unconditional discounts¹ will be critical • B-BBEE status of company - Preference points will be awarded to a bidder for attaining the B-BBEE status level of contribution in accordance with the table indicated in Annexure A.
--	--

16 Validity Period

Transnet desires a **validity period of 90 [ninety] days** from the closing date of this RFQ.

This RFQ is valid until _____.

17 Banking Details

BANK: _____

BRANCH NAME / CODE: _____

ACCOUNT HOLDER: _____

ACCOUNT NUMBER: _____

18 Company Registration

Registration number of company / C.C. _____

Registered name of company / C.C. _____

19 Disclosure of Prices Quoted

Respondents must indicate here whether Transnet may disclose their quoted prices and conditions to other Respondents:

YES NO

¹ Only unconditional discounts will be taken into account during evaluation. A discount which has been offered conditionally will, despite not being taken into account for evaluation purposes, be implemented when payment is effected.

20 Returnable Documents

Returnable Documents means all the documents, Sections and Annexures, as listed in the tables below.

- a) Respondents are required to submit with their Quotations the **mandatory Returnable Documents**, as detailed below.

Failure to provide all these Returnable Documents at the Closing Date and time of this RFQ will result in a Respondent's disqualification. Respondents are therefore urged to ensure that all these Documents are returned with their Quotations.

All Sections, as indicated in the footer of each page, must be signed, stamped and dated by the Respondent. Please confirm submission of these mandatory Returnable Documents by so indicating [Yes or No] in the table below:

Mandatory Returnable Documents	Submitted [Yes or No]
SECTION 2 : Quotation Form	
ANNEXURE C : Price Adjustment for Inflation.	
ANNEXURE D : Technical Questionnaire.	

- b) In addition to the requirements of section (a) above, Respondents are further required to submit with their Quotations the following **essential Returnable Documents** as detailed below.

Failure to provide all these Returnable Documents may result in a Respondent's disqualification. Respondents are therefore urged to ensure that all these documents are returned with their Quotations.

All Sections, as indicated in the footer of each page, must be signed, stamped and dated by the Respondent. Please confirm submission of these essential Returnable Documents by so indicating [Yes or No] in the table below:

Essential Returnable Documents	Submitted [Yes or No]
SECTION 1 : Notice to Bidders	
<ul style="list-style-type: none"> - Valid and original B-BBEE Verification Certificate or certified copy thereof [Large Enterprises and QSEs] Note: failure to provide a valid B-BBEE Verification Certificate at the closing date and time of the RFQ will result in an automatic score of zero for preference 	
<ul style="list-style-type: none"> - Valid and original B-BBEE certificate/sworn affidavit or certified copy thereof from auditor, accounting officer or SANAS accredited Verification Agency [EMEs] Note: failure to provide a valid B-BBEE Verification Certificate at the closing date and time of the RFQ will result in an automatic score of zero being allocated for preference 	

Essential Returnable Documents	Submitted [Yes or No]
- In the case of Joint Ventures, a copy of the Joint Venture Agreement or written confirmation of the intention to enter into a Joint Venture Agreement	
- Original valid Tax Clearance Certificate [Consortia / Joint Ventures must submit a separate Tax Clearance Certificate for each party]	
SECTION 3: Vendor Application Form <ul style="list-style-type: none"> • Original cancelled cheque or bank verification of banking details • Certified copies of IDs of shareholder/directors/members [as applicable] • Certified copies of the relevant company registration documents from Companies and Intellectual Property Commission (CIPC) • Certified copies of the company's shareholding/director's portfolio • Entity's letterhead • Certified copy of VAT Registration Certificate [RSA entities only] • Certified copy of valid Company Registration Certificate [if applicable] 	
ANNEXURE A : B-BBEE Preference Points Claim Form	
ANNEXURE B : Specification of Goods.	

"PREVIEW COPY ONLY"

 Respondent's Signature

 Date & Company Stamp

QUOTATION FORM

I/We _____
 hereby offer to supply the goods/services at the prices quoted in the Price Schedule below, in accordance with the conditions related thereto.

I/We agree to be bound by those terms and conditions in:

- the Standard Terms and Conditions for the Supply of Goods or Services to Transnet [Section 3 hereof]; and
- any other standard or special conditions mentioned and/or embodied in this Request for Quotation.

I/We accept that unless Transnet should otherwise decide and so inform me/us, this Quotation [and, if any, its covering letter and any subsequent exchange of correspondence], together with Transnet's acceptance thereof shall constitute a binding contract between Transnet and me/us.

I/We further agree that if, after I/we have been notified of the acceptance of my/our Quotation, I/we fail to deliver the said goods/service/s within the delivery lead-time quoted, Transnet may, without prejudice to any other legal remedy which it may have, cancel the order and recover from me/us any expenses incurred by Transnet in calling for Quotations afresh and/or having to accept any less favourable offer.

Price Schedule

I/We quote as follows for the goods required, on a "delivered nominated destination" basis, excluding VAT:

Item	Drawing Description	Qty	Rate	Total
1	M24 x 280 Bolt Stainless Steel 304	100		
2	M24 Nut Stainless steel 316	100		
3	M24 Flat Washer Stainless Steel 304	100		
4	M20 x 440mm Bolt Stainless Steel 304 Rolled Thread Length 90mm with Forged Head	200		
5	M20 x 400mm Bolt Stainless Steel 304 Rolled Thread Length 90mm with Forged Head	200		
6	M20 x 360mm Bolt Stainless Steel 304 Rolled Thread Length 90mm with Forged Head	200		
7	M20 x 330mm Bolt Stainless Steel 304 Rolled Thread Length 90mm with Forged Head	200		
8	M20 x 290mm Bolt Stainless Steel 304 Rolled Thread Length 90mm with Forged Head	1600		

Respondent's Signature _____

Date & Company Stamp _____

Item	Drawing Description	Qty	Rate	Total
9	M20 x 275mm Bolt Stainless Steel 304 Rolled Thread Length 90mm with Forged Head	200		
10	M20 x 240mm Bolt Stainless Steel 304 Rolled Thread Length 90mm with Forged Head	200		
11	M20 x 190mm Bolt Stainless Steel 304	200		
12	M20 x 50mm Setscrew Stainless Steel 304	250		
13	M20 Nut Stainless Steel 316	3300		
14	M20 Flat Washer Stainless Steel 304	3300		
15	M16 X 400mm Bolt Stainless Steel 304 Rolled Thread Length 90mm with forged Head	2000		
16	M16 X 360mm Bolt Stainless Steel 304 Rolled Thread Length 90mm with forged Head	500		
17	M16 X 290mm Bolt stainless Steel 304 Rolled Thread Length 90mm with forged Head	800		
18	M16 X 330mm Bolt stainless Steel 304 Rolled Thread Length 90mm with forged Head	300		
19	M16 X 260mm Bolt stainless Steel 304 Rolled Thread Length 90mm with forged Head	300		
20	M16 X 50mm Setscrew Stainless Steel 304	200		
21	M16 X 220mm Bolt Stainless Steel 304	100		
22	M16 X 155mm Bolt Stainless Steel 304	100		
23	M16 X 40mm Flat Stainless Steel 304	200		
24	M16 X 240mm Bolt Stainless Steel 304	400		
25	M16 Flat washer Stainless Steel 304	5000		
26	M16 Nuts Stainless Steel 316	5000		
27	M12 x 110 Bolt Stainless Steel 304	100		
28	M12 x 40 Bolt Stainless Steel 304	100		
29	M12 x 65 Setscrew Stainless Steel 304	100		
30	M12 x 90mm Setscrew Stainless Steel 304	100		
31	M12 Nut Stainless Steel 316	550		
32	M12 Flat washer Stainless Steel 304	550		
33	M20 x 1m long Threaded Bar Stainless Steel 304	100		
34	M20 Hook Bolt as per Drawing. CEE - TX - 15 Item 10	50		
35	Bolt Hook M16 as per Drawing.CEE-TX-14,Item 3, A-100mm,B-50mm	100		
36	M16 Hook Bolt as per Drawing. CEE - TX - 14 Item 2	100		
37	M12 U-Bolt Stainless Steel 304 as per Drawing.CEE-TX-97	150		
38	M12 U-Bolt Stainless Steel 304 as per Drawing.CEE-TX-23	4500		
39	M12 U-Bolt Stainless Steel 304 as per Drawing.CEE-TX-89	100		

Item	Drawing Description	Qty	Rate	Total
40	Pin Straight Head 24mm Dia Stainless Steel 304 as per Drawing. CEE - TX - 0059	100		
41	Pivot Pin 16mm Dia Stainless Steel 304 as per Drawing. CEE - TX - 0119	1400		
42	Clevis Pin 16mm Dia Stainless Steel 304 as per Drawing. CEE - TX - 0066	3000		
43	Pivot Pin 16mm Dia. Stainless Steel 304. As per Drawing. CEE - TN - 197	100		
44	Pin Stay Wire. Material 304 Stainless Steel as per Drawing. CEE - TNE - 31 Sheet 3	50		
45	Eye Bolt as per Drawing. CEE - TX -27	120		
46	M13 Wire Rope Clamp Drop Forged HDG	800		
47	Dowel Pin Stainless Steel 10mm Dia x 50L	100		
48	Washer packing as per Drawing. CEE - TX - 28	50		
49	M36 Nut HDG	150		
50	M36 Flat Washer HDG	150		
51	6,3mm Dia x 56mm Long Split Pin S/Steel 304	2000		
52	6,3mm Dia x 80mm Long Split Pin S/Steel 304	400		

Delivery Lead-Time from date of purchase order: _____ [days/weeks]

Notes to Pricing:

- All Prices must be quoted in South African Rand, exclusive of VAT
- To facilitate like-for-like comparison bidders must submit pricing strictly in accordance with this price schedule and not utilise a different format. Deviation from this pricing schedule could result in a bid being disqualified.
- Please note that should you have offered a discounted price(s), Transnet will only consider such price discount(s) in the final evaluation stage if offered on an unconditional basis.
- Prices are to be quoted firm and fixed, including the delivery and offloading cost, to our site, as specified on the first (cover) page of the tender document.
- All items on the Pricing Schedule should be priced / completed; if not, it will result in a bid being disqualified. (All 52 Items.)

Section 3

STANDARD TERMS AND CONDITIONS FOR THE SUPPLY OF GOODS OR SERVICES TO TRANSNET

A Supplier/Service Provider shall be obliged to adhere to the Standard Terms and Conditions for the Supply of Goods and Services to Transnet as expressed hereunder. Should the Respondent find any condition(s) unacceptable, it should indicate which condition(s) is/are unacceptable and offer an alternative(s). A Quotation submitted by a Respondent will be subjected to review and acceptance or rejection of its proposed contractual terms and conditions by Transnet's Legal Counsel, prior to consideration for an award of business.

1 SOLE AGREEMENT

Unless otherwise agreed in writing, these terms [Terms and each Term] and Transnet's purchase order(s) [Order or Orders] represent the only conditions upon which Transnet SOC Ltd [Transnet] procures goods [the Goods] or services [the Services] specified in the Order from the person to whom the Order is addressed [the Supplier/Service Provider]. Transnet does not accept any other conditions which the Supplier/Service Provider may specify, unless otherwise agreed to by Transnet in writing. In the event of any inconsistency between these Terms and any Order, these Terms shall take precedence.

2 CONFORMITY WITH ORDER

Goods/Services shall conform strictly with the Order. The Supplier/Service Provider shall not vary the quantities specified and/or the specification, if any, stipulated in the Order, without the prior written consent of Transnet. The Supplier/Service Provider warrants that the Goods/Services shall be fit for their purpose and of satisfactory quality.

3 DELIVERY AND TITLE

3.1 The delivery dates and addresses are those in the Order. Time shall be of the essence in respect of the Supplier's/Service Provider's obligations under the Order.

3.2 The Supplier/Service Provider will not be excused for delay in delivery or performance except due to circumstances outside its control and then only subject to the Supplier/Service Provider having notified Transnet in writing on becoming aware of such circumstances. Transnet may terminate an Order, in whole or in part, without incurring any liability to the Supplier/Service Provider if such a delay becomes, in Transnet's absolute opinion, significant.

3.3 Risk of loss or damage to Goods shall pass to Transnet on delivery and acceptance, and title shall pass to Transnet when payment to the Supplier for the Goods has been effected.

3.4 If on delivery, the Goods/Services do not conform to the Order, Transnet may reject the Goods/Services and the Supplier/Service Provider shall promptly rectify any defects or in Transnet's opinion, supply appropriate replacement Goods/Services at the Supplier's/Service Provider's expense within the specified delivery times, without any liability due by Transnet. Goods shall be subject to such testing and/or inspection as Transnet may consider necessary.

4 PRICE AND PAYMENT

- 4.1 Prices specified in an Order cannot be increased. Payment for the Goods/Services shall be made by Transnet against an original undisputed invoice(s) [a Tax Invoice], supporting documentation and month-end statement from the Supplier/Service Provider. Tax Invoices plus supporting documentation shall be posted to the address shown in the Order.
- 4.2 Payment of the Supplier's/Service Provider's valid Tax Invoice(s) will be made by Transnet in the South African currency and on the terms stated in the Order, the standard payment terms being 30 [thirty] days from date of receipt by Transnet of a month-end statement, unless otherwise agreed to in writing. Transnet shall arrange for payment of such Tax Invoices and any pre-authorised additional expenses incurred, provided that the authorised expenses are supported by acceptable documentary proof of expenditure incurred [where this is available]. Any amounts due in terms of these Terms shall be paid to the Supplier/Service Provider, taking into account any deduction or set-off and bank charges.

5 PROPRIETARY RIGHTS LIABILITY

If any allegations should be made or any claim asserted against Transnet that ownership of, or any act or omission by Transnet in relation to Goods/Services or any written material provided to Transnet relating to any Goods/Services or pursuant to an Order, being a violation or infringement of any third party's contractual, industrial, commercial or intellectual property rights including but not limited to any patent, registered design, design right, trade mark, copyright or service mark on any application thereof, the Supplier/Service Provider hereby indemnifies Transnet against and hold it harmless from any and all losses, liabilities, costs, claims, damages and expenses [including any legal fees] arising directly or indirectly from such allegation or claim provided that this indemnity shall not apply where the allegation or claim arises solely as a result of the Supplier/Service Provider following a design or process originated and furnished by Transnet. The Supplier/Service Provider shall either

- a) procure for Transnet the right to continue using the infringing Goods; or
- b) modify or replace the Goods/Services so that they become non-infringing,

provided that in both cases the Goods/Services shall continue to meet Transnet's requirements and any specifications stipulated in the Order. Should neither option be possible, the Supplier/Service Provider may remove, with Transnet's prior written consent, such Goods/Services and will pay to Transnet a sum equivalent to the purchase price. If Transnet refuses to give such consent, the Supplier/Service Provider shall have no liability in respect of any continued use of the infringing Goods/Services after Supplier's/Service Provider's prior written request to remove the same.

6 PROPRIETARY INFORMATION

All information which Transnet has divulged or may divulge to the Supplier/Service Provider and any information relating to Transnet's business which may have come into the Supplier's/Service Provider's possession whilst carrying out an Order, and the existence of the Order, shall be treated by the Supplier/Service Provider as confidential information and shall not, without Transnet's prior written consent, be disclosed to any third party, or be used or copied for any purposes other than to perform the Order. This clause does not apply to information which is public knowledge or available from other sources other than by breach of this Term. Upon request by Transnet, the Supplier/Service Provider shall return all

materials issued pursuant to the Order and, pending this, shall protect Transnet's rights in any such materials. Such confidential information shall at all material times be the property of Transnet.

7 DEVELOPMENT WORK IN THE PRODUCTION OF GOODS

If the production or provision of any Goods involves research and/or development which are wholly or partly funded by Transnet, then all intellectual property or other rights as a result thereof shall be the property of Transnet on creation.

8 PUBLICITY

The Supplier/Service Provider shall not name Transnet or use its trademarks, service marks [whether registered or not] or Goods in connection with any publicity without Transnet's prior written consent.

9 AFTER SALES SERVICE

The Supplier shall provide replacement parts necessary to ensure the uninterrupted operation of the Goods supplied for the duration of the warranty period, from delivery of any particular item of the Goods and if requested by Transnet shall make these parts available to a third party maintainer of Transnet's choice at the same price as if the parts had been supplied to Transnet. The Supplier undertakes to provide a maintenance service for Goods, should Transnet so request, on terms to be agreed. If the Order so indicates, the Supplier will provide a warranty service for the Goods at a level to be agreed with Transnet.

10 TERMINATION OF ORDER

10.1 Transnet may cancel an Order in whole or in part at any time upon at least 7 [seven] days' written notice to the Supplier/Service Provider, or when there is a change in control of the Supplier/Service Provider or the Supplier/Service Provider commits any serious breach or any repeated or continued material breach of its obligations under these Terms and/or Order or shall have been guilty of conduct tending to bring itself into disrepute, on written notice to the Supplier/Service Provider when such work on the Order shall stop.

10.2 Transnet shall pay the Supplier/Service Provider a fair and reasonable price for justified work in progress, where such price reflects only those costs not otherwise recoverable by the Supplier/Service Provider, at the time of termination, and the Supplier/Service Provider shall give Transnet full assistance to check the extent of such work in progress. Payment of such price shall be in full and final satisfaction of any claims arising out of such termination and upon such payment the Supplier/Service Provider shall deliver to Transnet all work, including any materials, completed or in progress. The sum payable to the Supplier/Service Provider under this clause will not in any event exceed the total amount that would have been payable to the Supplier/Service Provider had the Order not been terminated.

10.3 In the event of termination the Supplier/Service Provider must submit all claims within 2 [two] months of termination after which time claims will only be met in what Transnet considers exceptional circumstances.

10.4 If the Goods or Services are not provided in accordance with an Order, the Order shall be deemed terminated and the Supplier/Service Provider shall compensate Transnet for any costs incurred in obtaining substitute Goods or any damage caused due to the failure or delay in the delivery.

11 ACCESS

The Supplier/Service Provider shall be liable for the acts, omissions and defaults of its personnel or agents who, for the purposes of the Order, shall be treated as if they are the Supplier's/Service Provider's employees. The Supplier/Service Provider shall ensure that any such personnel or agents, whilst on Transnet premises, shall comply with Transnet's health and safety, security and system security rules and procedures as and where required.

12 WARRANTY

The Supplier/Service Provider warrants that it is competent to supply the Goods/Services in accordance with these Terms to the reasonable satisfaction of Transnet and that all Goods/Services delivered under the Order: (a) conform and comply in all relevant legislation, standards, directives and orders related to *[inter alia]* the supply, manufacture and use of the Goods/Services in force at the time of delivery, and to any specifications referred to in the Order; (b) will not cause any deterioration in the functionality of any Transnet equipment; and (c) do not infringe any third party rights of any kind. The Supplier/Service Provider hereby indemnifies Transnet against all losses, liabilities, costs, claims, damages, expenses and awards of any kinds incurred or made against Transnet in connection with any breach of this warranty.

13 INSOLVENCY

If the Supplier/Service Provider shall have a receiver, manager, administrator, liquidator or like person appointed over all or any part of its assets or if the Supplier/Service Provider compounds with its creditors or passes a resolution for the winding up or administration of the Supplier/Service Provider, Transnet is at liberty to terminate the Order or orders forthwith, or at its option, to seek performance by any such appointed person.

14 ASSIGNMENT

The Supplier/Service Provider shall not assign its obligations under an Order without Transnet's prior written consent, which consent shall not be unreasonably withheld or delayed.

15 NOTICES

Notices under these Terms shall be delivered by hand to the relevant addresses of the parties in the Order or may be served by facsimile or by email, in which event notice shall be deemed served on acknowledgement of receipt by the recipient.

16 LAW

Orders shall be governed by and interpreted in accordance with South African law and any disputes arising herein shall be subject to South African arbitration under the rules of the Arbitration Foundation of South Africa, which rules are deemed incorporated by reference in this clause. The reference to arbitration shall not prevent Transnet referring the matter to any South African courts, having jurisdiction, to which the Supplier/Service Provider hereby irrevocably submits but without prejudice to Transnet's right to take proceedings against the Supplier/Service Provider in other jurisdictions and/or obtaining interim relief on an urgent basis from a court of competent jurisdiction pending the decision in other courts or from instituting in any court of competent jurisdiction any proceedings for an interdict or any other injunctive relief. If the Supplier/Service Provider does not have a registered office in the South Africa it will at all times maintain

an agent for service of process in South Africa and shall give Transnet the name and address of such agent as such may be amended, in writing, from time to time.

17 GENERAL

Completion or termination of an Order shall be without prejudice to any Term herein which by its nature would be deemed to continue after completion or termination, including but not limited to clauses 5, 6 and 10. Headings are included herein for convenience only. If any Term herein be held illegal or unenforceable, the validity or enforceability of the remaining Terms shall not be affected. No failure or delay by Transnet to enforce any rights under these Terms will operate as a waiver thereof by Transnet. All rights and remedies available to either party under these Terms shall be in addition to, not to the exclusion of, rights otherwise available at law.

18 COUNTERPARTS

These Terms and conditions may be signed in any number of counterparts, all of which taken together shall constitute one and the same instrument. Any party may enter into this agreement by signing any such counterpart.

"PREVIEW COPY ONLY"

By signing this RFQ document, the Respondent is deemed to acknowledge that he/she has made himself/herself thoroughly familiar with all the conditions governing this RFQ, including those contained in any printed form stated to form part hereof and Transnet SOC Ltd will recognise no claim for relief based on an allegation that the Respondent overlooked any such condition or failed to properly take it into account for the purpose of calculating quoted prices or otherwise.

SIGNED at _____ on this ____ day of _____ 20__

.....
SIGNATURE OF RESPONDENT'S AUTHORISED REPRESENTATIVE

NAME: _____

DESIGNATION: _____

REGISTERED NAME OF COMPANY: _____

PHYSICAL ADDRESS:

Respondent's contact person *[Please complete]*

Name	:	
Designation	:	
Telephone	:	
Cell Phone	:	
Facsimile	:	
Email	:	
Website	:	

**Transnet urges its clients, suppliers and the general public to report any fraud or corruption to
TIP-OFFS ANONYMOUS : 0800 003 056**

Section 4
VENDOR APPLICATION FORM

Respondents are to furnish the following documentation and complete the Vendor Application Form below:

1. **Original** cancelled cheque **OR** letter from the Respondent's bank verifying banking details **[with bank stamp]**
2. **Certified** copy of Identity Document(s) of Shareholders/Directors/Members [where applicable]
3. **Certified copies** of the relevant company registration documents from Companies and Intellectual Property Commission (CIPC)
4. **Certified copies** of the company's shareholding/director's portfolio
5. A letter on the company's letterhead confirm physical and postal addresses
6. **Original** valid SARS Tax Clearance Certificate
7. **Certified copy** of VAT Registration Certificate
8. **A valid and original** B-BBEE Verification Certificate / sworn affidavit **or certified copy** thereof meeting the requirements for B-BBEE compliance as per the B-BBEE Codes of Good Practice
9. **Certified copy** of valid Company Registration Certificate [if applicable]

Vendor Application Form

Company trading name							
Company registered name							
Company Registration Number or ID Number if a Sole Proprietor							
Form of entity [√]	CC	Trust	Pty Ltd	Limited	Partnership	Sole Proprietor	
VAT number [if registered]							
Company telephone number							
Company fax number							
Company email address							
Company website address							
Bank name				Branch & Branch code			
Account holder				Bank account number			
Postal address							

		Code	
Physical Address		Code	
Contact person			
Designation			
Telephone			
Email			
Annual turnover range [last financial year]	< R5 m	R5 - 35 m	> R35 m
Does your company provide	Products	Services	Both
Area of delivery	National	Provincial	Local
Is your company a public or private entity	Public	Private	
Does your company have a Tax Directive or IRP30 Certificate	Yes	No	
Main product or services [e.g. Stationery/consulting]			

Complete B-BBEE Ownership Details:

% Black ownership	% Black women ownership	% Disabled Black ownership	% Youth ownership
Does your entity have a B-BBEE certificate		Yes	No
What is your B-BBEE status [Level 1 to 9 / Unknown]			
How many personnel does the entity employ		Permanent	Part time

If you are an existing Vendor with Transnet please complete the following:

Transnet contact person	
Contact number	
Transnet Operating Division	

Duly authorised to sign for and on behalf of Company / Organisation:

Name		Designation	
Signature		Date	

ANNEXURE A: B-BBEE PREFERENCE POINTS CLAIM FORM

FOR THE SUPPLY & DELIVERY OF VARIOUS SIZES SUPPLY & DELIVER, VARIOUS SIZES STAINLESS STEEL FASTENERS, ON AN "AS & WHEN" BASIS, FOR A 24 MONTH PERIOD.

This preference form contains general information and serves as a claim for preference points for Broad-Based Black Economic Empowerment [B-BBEE] Status Level of Contribution.

1. INTRODUCTION

- 1.1 A total of 10 preference points shall be awarded for B-BBEE Status Level of Contribution.
- 1.2 Failure on the part of a Bidder to fill in and/or to sign this form and submit a B-BBEE Verification Certificate from a Verification Agency accredited by the South African Accreditation System [SANAS] or a Registered Auditor approved by the Independent Regulatory Board of Auditors [IRBA] or an Accounting Officer as contemplated in the Close Corporation Act [CCA] together with the bid will be interpreted to mean that preference points for B-BBEE Status Level of Contribution are not claimed.
- 1.3 Transnet reserves the right to require of a Bidder, either before a Bid is adjudicated or at any time subsequently, to substantiate any claim in regard to preferences, in any manner required by Transnet.

2. GENERAL DEFINITIONS

- 2.1 **"all applicable taxes"** include value-added tax, pay as you earn, income tax, unemployment insurance fund contributions and skills development levies;
- 2.2 **"B-BBEE"** means broad-based black economic empowerment as defined in section 1 of the Broad-Based Black Economic Empowerment Act;
- 2.3 **"B-BBEE status of contributor"** means the B-BBEE status received by a measured entity based on its overall performance using the relevant scorecard contained in the Codes of Good Practice on Black Economic Empowerment, issued in terms of section 9(1) of the Broad-Based Black Economic Empowerment Act;
- 2.4 **"Bid"** means a written offer in a prescribed or stipulated form in response to an invitation by Transnet for the provision of goods, works or services;
- 2.5 **"Broad-Based Black Economic Empowerment Act"** means the Broad-Based Black Economic Empowerment Act, 2003 [Act No. 53 of 2003];
- 2.6 **"comparative price"** means the price after the factors of a non-firm price and all unconditional discounts that can utilised have been taken into consideration;
- 2.7 **"consortium or joint venture"** means an association of persons for the purpose of combining their expertise, property, capital, efforts, skills and knowledge in an activity for the execution of a

Respondent's Signature

Date & Company Stamp

- contract;
- 2.8 **"contract"** means the agreement that results from the acceptance of a bid by Transnet;
- 2.9 **"EME"** means any enterprise with an annual total revenue of R5 [five] million or less as per the 2007 version of the B-BBEE Codes of Good Practice and means any enterprise with an annual total revenue of R10 [ten] million or less as per the Revised Codes of Good Practice issued on 11 October 2013 in terms of Government Gazette No. 36928;
- 2.10 **"firm price"** means the price that is only subject to adjustments in accordance with the actual increase or decrease resulting from the change, imposition, or abolition of customs and excise duty and any other duty, levy, or tax, which, in terms of the law or regulation, is binding on the contractor and demonstrably has an influence on the price of any supplies, or the rendering costs of any service, for the execution of the contract;
- 2.11 **"functionality"** means the measurement according to predetermined norms, as set out in the bid documents, of a service or commodity that is designed to be practical and useful, working or operating, taking into account, among other factors, the quality, reliability, viability and durability of a service and the technical capacity and ability of a bidder;
- 2.12 **"non-firm prices"** means all prices other than "firm" prices;
- 2.13 **"person"** includes reference to a juristic person;
- 2.14 **"QSE"** means any enterprise with an annual total revenue between R5 [five] million and R35 [thirty five] million as per the 2007 version of the B-BBEE Codes of Good Practice and means any enterprise with an annual total revenue of between R10 [ten] million and R50 [fifty] million as per the Revised Codes of Good Practice issued on 11 October 2013 in terms of Government Gazette No. 36928
- 2.15 **"rand value"** means the total estimated value of a contract in South African currency, calculated at the time of bid invitations, and includes all applicable taxes and excise duties;
- 2.16 **"subcontract"** means the primary contractor's assigning or leasing or making out work to, or employing another person to support such primary contractor in the execution of part of a project in terms of the contract;
- 2.17 **"total revenue"** bears the same meaning assigned to this expression in the Codes of Good Practice on Black Economic Empowerment, issued in terms of section 9(1) of the Broad-Based Black Empowerment Act and promulgated in the Government Gazette on 9 February 2007;
- 2.18 **"trust"** means the arrangement through which the property of one person is made over or bequeathed to a trustee to administer such property for the benefit of another person; and
- 2.19 **"trustee"** means any person, including the founder of a trust, to whom property is bequeathed in order for such property to be administered for the benefit of another person.

 Respondent's Signature

 Date & Company Stamp

3. ADJUDICATION USING A POINT SYSTEM

- 3.1 The Bidder obtaining the highest number of total points for the evaluation criteria as enumerated in Section 2 of the RFP will be awarded the contract, unless objective criteria justifies the award to another bidder.
- 3.2 Preference points shall be calculated after prices have been brought to a comparative basis taking into account all factors of non-firm prices and all unconditional discounts.
- 3.3 Points scored will be rounded off to 2 [two] decimal places.
- 3.4 In the event of equal points scored, the Bid will be awarded to the Bidder scoring the highest number of preference points for B-BBEE.
- 3.5 However, when functionality is part of the evaluation process and two or more Bids have scored equal points including equal preference points for B-BBEE, the successful Bid will be the one scoring the highest score for functionality.
- 3.6 Should two or more Bids be equal in all respect, the award shall be decided by the drawing of lots.

"PREVIEW COPY ONLY"

4. POINTS AWARDED FOR B-BBEE STATUS LEVEL OF CONTRIBUTION

- 4.1 In terms of the Preferential Procurement Regulations, 2011, preference points shall be awarded to a Bidder for attaining the B-BBEE status level of contribution in accordance with the table below:

B-BBEE Status Level of Contributor	Number of Points [Maximum 20]
1	10
2	9
3	8
4	5
5	4
6	3
7	2
8	1
Non-compliant contributor	0

- 4.2 Bidders who qualify as EMEs in terms of the 2007 version of the Codes of Good Practice must submit a certificate issued by an Accounting Officer as contemplated in the CCA or a Verification Agency accredited by SANAS or a Registered Auditor. Registered auditors do not need to meet the prerequisite for IRBA's approval for the purpose of conducting verification and issuing EME's with B-BBEE Status Level Certificates.
- 4.3 Bidders who qualify as EMEs in terms of the Revised Codes of Good Practice issued on 11 October 2013 in terms of Government Gazette No. 36928 are only required to obtain a sworn affidavit on an annual basis confirming that the entity has an Annual Total Revenue of R10 million or less and the entity's Level of Black ownership.
- 4.4 In terms of the 2007 version of the Codes of Good Practice, Bidders other than EMEs must submit their original and valid B-BBEE status level verification certificate or a certified copy thereof, substantiating their B-BBEE rating issued by a Registered Auditor approved by IRBA or a Verification Agency accredited by SANAS.
- 4.5 In terms of the Revised Codes of Good Practice issued on 11 October 2013 in terms of Government Gazette No. 36928, Bidders who qualify as QSEs are only required to obtain a sworn affidavit on an annual basis confirming that the entity has an Annual Total Revenue of R50 million or less and the entity's Level of Black ownership. Large enterprises must submit their original and valid B-BBEE status level verification certificate or a certified copy thereof, substantiating their B-BBEE rating issued by a Registered Auditor approved by IRBA or a Verification Agency accredited by SANAS.
- 4.6 A trust, consortium or joint venture will qualify for points for its B-BBEE status level as a legal entity, provided that the entity submits its B-BBEE status level certificate.
- 4.7 A trust, consortium or joint venture will qualify for points for their B-BBEE status level as an unincorporated entity, provided that the entity submits their consolidated B-BBEE scorecard as if they were a group structure and that such a consolidated B-BBEE scorecard is prepared for every separate bid.
- 4.8 Tertiary institutions and public entities will be required to submit their B-BBEE status level certificates in terms of the specialised scorecard contained in the B-BBEE Codes of Good Practice.

Respondent's Signature

Date & Company Stamp

- 4.9 A person will not be awarded points for B-BBEE status level if it is indicated in the Bid documents that such a Bidder intends subcontracting more than 25% [twenty-five per cent] of the value of the contract to any other enterprise that does not qualify for at least the same number of points that such a Bidder qualifies for, unless the intended subcontractor is an EME that has the capability and ability to execute the subcontract.
- 4.10 A person awarded a contract may not subcontract more than 25% [twenty-five per cent] of the value of the contract to any other enterprise that does not have an equal or higher B-BBEE status level than the person concerned, unless the contract is subcontracted to an EME that has the capability and ability to execute the subcontract.
- 4.11 Bidders are to note that in terms of paragraph 2.6 of Statement 000 of the Revised Codes of Good Practice issued on 11 October 2013 in terms of Government Gazette No. 36928, any representation made by an entity about its B-BBEE compliance must be supported by suitable evidence or documentation. As such, Transnet reserves the right to request such evidence or documentation from Bidders in order to verify any B-BBEE recognition claimed.

5. B-BBEE STATUS AND SUBCONTRACTING

5.1 Bidders who claim points in respect of B-BBEE Status Level of Contribution must complete the following:

B-BBEE Status Level of Contributor _____ = _____ [maximum of 10 points]

Note: Points claimed in respect of this paragraph 5.1 must be in accordance with the table reflected in paragraph 4.1 above and must be substantiated by means of a B-BBEE certificate issued by a Verification Agency accredited by SANAS or a Registered Auditor approved by IRBA or a sworn affidavit in the case of an EME or QSE.

5.2 Subcontracting

Will any portion of the contract be subcontracted? YES/NO [delete which is not applicable]

If YES, indicate:

- (i) What percentage of the contract will be subcontracted?%
- (ii) The name of the subcontractor
- (iii) The B-BBEE status level of the subcontractor
- (iv) Is the subcontractor an EME? YES/NO

5.3 Declaration with regard to Company/Firm

- (i) Name of Company/Firm.....
- (ii) VAT registration number.....
- (iii) Company registration number.....
- (iv) Type of Company / Firm [TICK APPLICABLE BOX]
 - Partnership/Joint Venture/Consortium
 - One person business/sole propriety
 - Close Corporations
 - Company (Pty) Ltd

Respondent's Signature

Date & Company Stamp

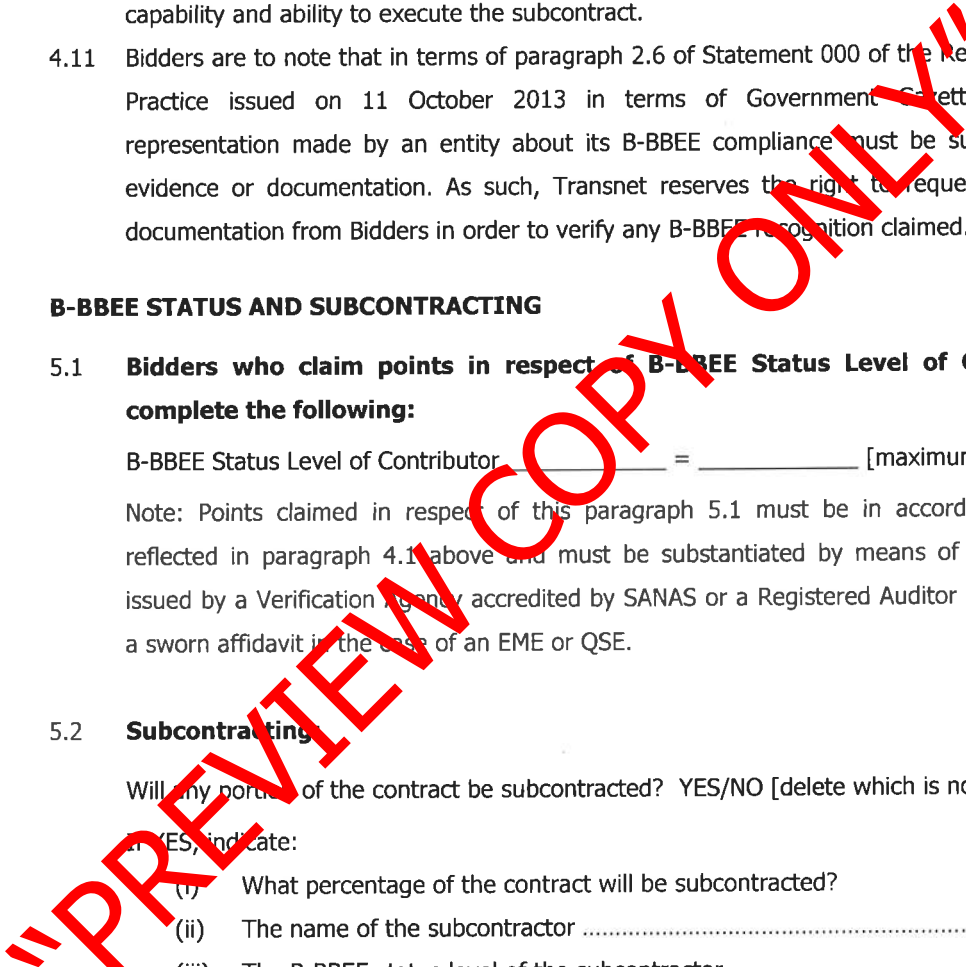

(v) Describe Principal Business Activities

.....
.....
.....

(vi) Company Classification [TICK APPLICABLE BOX]

- Manufacturer
- Supplier
- Professional Service Provider
- Other Service Providers, e.g Transporter, etc

(vii) Total number of years the company/firm has been in business.....

BID DECLARATION

I/we, the undersigned, who warrants that he/she is duly authorised to do so on behalf of the company/firm, certify that points claimed, based on the B-BBEE status level of contribution indicated in paragraph 4 above, qualifies the company/firm for the preference(s) shown and I / we acknowledge that:

- (i) The information furnished is true and correct.
- (ii) In the event of a contract being awarded as a result of points claimed as shown in paragraph 6 above, the contractor may be required to furnish documentary proof to the satisfaction of Transnet that the claims are correct.
- (iii) If the B-BBEE status level of contribution has been claimed or obtained on a fraudulent basis or any of the conditions of contract have not been fulfilled, Transnet may, in addition to any other remedy it may have:
 - (a) disqualify the person from the bidding process;
 - (b) recover costs, losses or damages it has incurred or suffered as a result of that person's conduct;
 - (c) cancel the contract and claim any damages which it has suffered as a result of having to make less favourable arrangements due to such cancellation;
 - (d) restrict the Bidder or contractor, its shareholders and directors, and/or associated entities, or only the shareholders and directors who acted in a fraudulent manner, from obtaining business from Transnet for a period not exceeding 10 years, after the *audi alteram partem* [hear the other side] rule has been applied; and/or
 - (e) forward the matter for criminal prosecution.

"PREVIEW COPY ONLY"

WITNESSES:

- 1.
- 2.

SIGNATURE OF BIDDER

DATE:.....

COMPANY NAME:

ADDRESS:.....

ANNEXURE B: SPECIFICATION OF GOODS**FOR THE SUPPLY & DELIVER VARIOUS SIZES STAINLESS STEEL FASTENERS, ON AN "AS & WHEN" BASIS, FOR A 24 MONTH PERIOD.****1. SCOPE**

The contract will be for the manufacture, supply & delivery of various sizes stainless steel fasteners, as per the attached drawing numbers;

- CEE – TX – 14
- CEE – TX – 97
- CEE – TX – 23
- CEE – TX – 89
- CEE – TX – 119
- CEE – TN – 197
- CEE – TX – 59
- CEE – TX – 27
- CEE – TX – 28
- CEE – TNE – 31
- CEE – TX – 15
- CEE – TX – 66

2. SPECIFICATIONS

Transnet only approves items supplied according to Transnet's Certificate of approval.

The specification of each item is detailed in Section 2 the Quotation form.

3. DELIVERY REQUIREMENTS

All the fastener items are required at TFR (OHTE) Store, 1 Morris Road, Empangeni Rail, Old Goods Shed Area.

4. SITE REQUIREMENTS

All personnel to be fully dressed with standard PPE at all times and adhere to site safety requirements. The delivery vehicle to be fully road worthy, with no fuel / oil leaks at all.

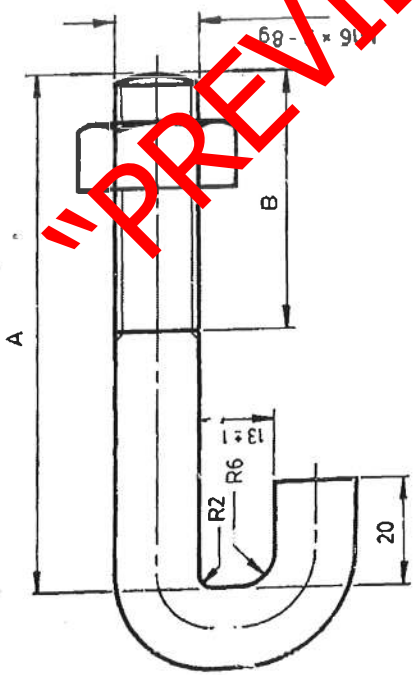

NOTES / OPMERKINGS

- FABRICATION: FORM HOOK AT 875° - 900°C
VERVAARDIGING: VORM HAAK TEEN 875° - 900°C
- NORMALISE: REHEAT UNIFORMLY THROUGHOUT TO 875° - 900°C AND ALLOW TO COOL FREELY IN AIR.
NORMALISEER: HERVERWARM HEELTEMAL TOT 875° - 900°C EN LAAT AFKOEL IN LUG.
- FINISH: ZINC COAT TO SPEC. SABS 763.
AFWERKING: SINKBEDEK VOLG. SPES.

DIMENSIONS: MILLIMETRES
AFMETINGS: MILLIMETER

MATERIAL - MATERIAAL
STEEL, ROUND 4 16
STAAL, ROND GRADE 43A.
VOLG. BS 4360 GRAAD 43A.
OR CME9 SYMBOL 8.
OF SIMBOOL 8.

DRN. GET.	F. W. C.	GEN. TOLERANCES: LIN. ±2	ALG. TOLERANSIES: ANG/HOE.:
TRCD. NGT.	S. v. VUUREN	ENG. IR	J. S. SMUTS
CKD. NGS.	W. R. G.	DATE 45-12-14	DATUM for ns.
CHIEF ELECTRICAL ENGINEER ELEKTRIESE HOOFINGENIEUR		JOHANNESBURG	
SOUTH AFRICAN TRANSPORT SERVICES SUID-AFRIKAANSE VERVOERDIENSTE		PHOTRA	

ELECTRIFICATION TYPE: GENERAL
BOLT, HOOK, M16.
AND HEX. NUT.
ELEKTRIFIKASIE TIPE: ALGEMEEN.
BOUT, HAAK-, M16.
EN SESK. MOER.

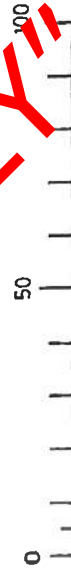

ITEM	DIM./AFM.		STORES ITEM NO. MAGASYNITEM	AMENDMENTS WYSIGINGS	
	A	B		NO.	NAME NAAM
1	60	30	(M)54/3443		
2	80	50	(M)54/3455		85-8-14
3	100	50	(M)54/3467		
4	120	50	(M)54/3479		
5	140	50	(M)54/3480		
6	160	50	(M)54/3492		
7	180	50	(M)54/3507		
8	200	50	(M)54/3519		
9	220	50	(M)54/3520		
10	240	50	(M)54/3532		
11	260	50	(M)54/3544		
12	280	50	(M)54/3556		
13	300	50	(M)54/3568		
14	550	70			
15					

REDRAWN AND REVISED.
OORGETEKEN EN HERSIEN.
MOD. ITEM NO'S BYGEVOEG.
D.O. REF. T1/85/74.
T.K.-VERW.

CLASS/ASSY. DRG.
KLAS/SAMEST.-TEK.

MODULUS ITEM NO.

PREVIOUS ITEM NO.
VORIGE

DRAWING NO. CEE-
TEKENING TX-14

SF. OF
VEL VAN

AMENDMENTS		
NO.	NAME	DATE
1	A. VERSTEEG	93-3-9

U-BOLT WAS COMPLETELY THREADED.
DO REF T92/026

ITEM	DESCRIPTION	QTY	STORES ITEM NO	CRS NO	CEE-
1	STEEL, ROUND, M12 x 168L	1	(11/2740)		
2	WASHER, LOCK, STEEL, SINGLE COIL, GALV, M12	2	1/32850		
3	NUT, PLAIN, HEX, STEEL, GALV, M12	2	1/32856		

"PREVIEW COPY ONLY"

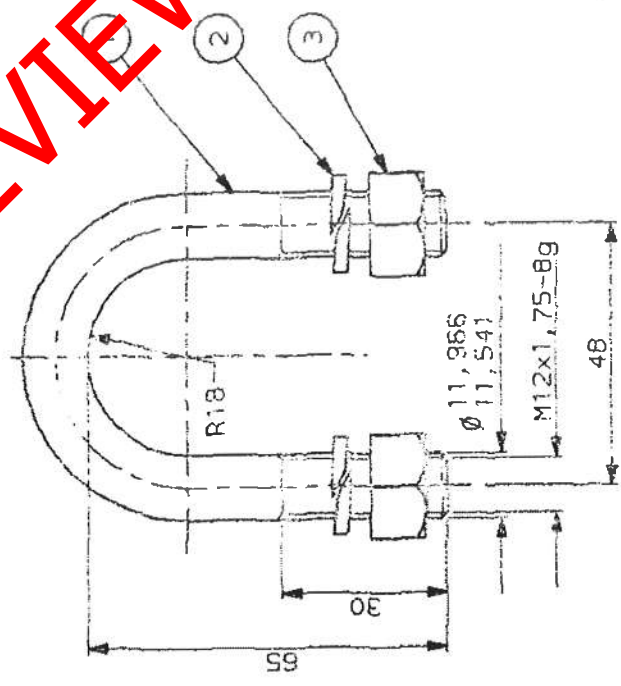

FINISH STAINLESS STEEL

STORES ITEM NO	
DIMENSIONS: mm	
SCALE:	1:1
DRAWING NO	CEE-
	TX-97
SHEET	OF

DO REF. T91/029	GEN TOL: LINE 0,5	ANGT	
DRN: W F MANS	CKD:	DATE: 91-07-08	
ENG:	W BRIGHT	for CHIEF ENG	
INFRASTRUCTURE (ELECTRICAL)			

U-BOLT, M12 x 48 CRS
FOR ATTACHING DANGER SIGNS ON PRO ARRANGEMENTS AT LOADING AREAS.

ITEM	DESCRIPTION ~ BESKRYWING	QTY HVLD	STORES MAGASYN NO.	AMENDMENTS WYSIGINGS
1.	STEEL, ROUND ϕ 12 x 225 L TO SPEC CME 9 SYM 7 STAAI, ROND	1.	(M) 1/2740	NO. NAME DATE NAAM DATUM
2.	NUT, PLAIN, HEX, STEEL, TO SPEC M12 MOER, GEWONE, SEK, STAAL, TO SPEC	2.	(M) 1/32856	2. B. Stewart 82-04-22
3.	WASHER, FLAT, STEEL, ROUND, NORMAL, TO SPEC M12 WASTER, PLAT, STAAL, ROND, NORMAAL, TO SPEC	2.	(M) 1/33659	REDRAWN IN INK. OORGETEKEN IN INK. D.O. REF. T1/81/74 TK.-VERW.

FINISH ~ AFWERKING.
~~TO SPEC~~
~~SINKEBEDEK VOLG. SPES.~~
 STAINLESS STEEL

DIMENSIONS : MILLIMETRES AFMETINGS : MILLIMETER	GEN. TOLERANCES : LIN. \pm 0,5 ALG. TOLERANSIES : ANG./HOEK \pm ---
DRN. B. v.d. WEST. GET.	D.O. REF. --- TK.-VERW. IR.
TRCD. K. HUGHES NGT.	DATE 30-02-13 DATUM: G.A. WILLIAMS
CKD. R.A. MACMILLAN NGS.	JOHANNESBURG
CHIEF ELECTRICAL ENGINEER ELEKTRIESE HOOFINGENIEUR	SOUTH AFRICAN TRANSPORT SERVICES SUID - AFRIKAANSE VERVOERDIENSTE

U - BOLT
M12
U - BOUT

TX-23

"PREVIEW COPY ONLY"

AMENDMENTS			
NO	NAME	DATE	
4	L O BORGARD	95-05-11	
REDRAWN, STAINLESS STEEL ADDED.			
DO REF T95/003			

M12x2.0-8g

NOTE

[REDACTED]

MATERIAL: ITEM NO 11/ — STEEL, ROUND, #12 X 127 LG OR STAINLESS STEEL DO REF: C29/71 GEN TOL: LIN± 1 ANG± — DRN: G N CKD: — DATE: 71-03-25 ENG: — F PIENAAR for CHIEF ENG	U-BOLT M12 SPOORNET INFRASTRUCTURE (ELECTRICAL)
--	---

DIMENSIONS: mm	SCALE: 1:1	A4	
			SHT — OF — TX 89 CEE-

10000776

3

4

4

4

3

AMENDMENTS		
NO	NAME	DATE
1	JVT	97-04-07

REVISED. DRG NO WAS TN-183. DO REF T96/001

ITEM	DESCRIPTION	QTY	STORES ITEM NO	DRG NO CEE-
1	RIVET, STEEL, SNAP HEAD, Ø16 x 160 LG	1		
2	LOCKING SPLIT PIN	1	54/3734	TX-54

DIMENSIONS: mm
SCALE: 1:1

 A4

DRG NO CEE--
TX-119

SHT — OF —

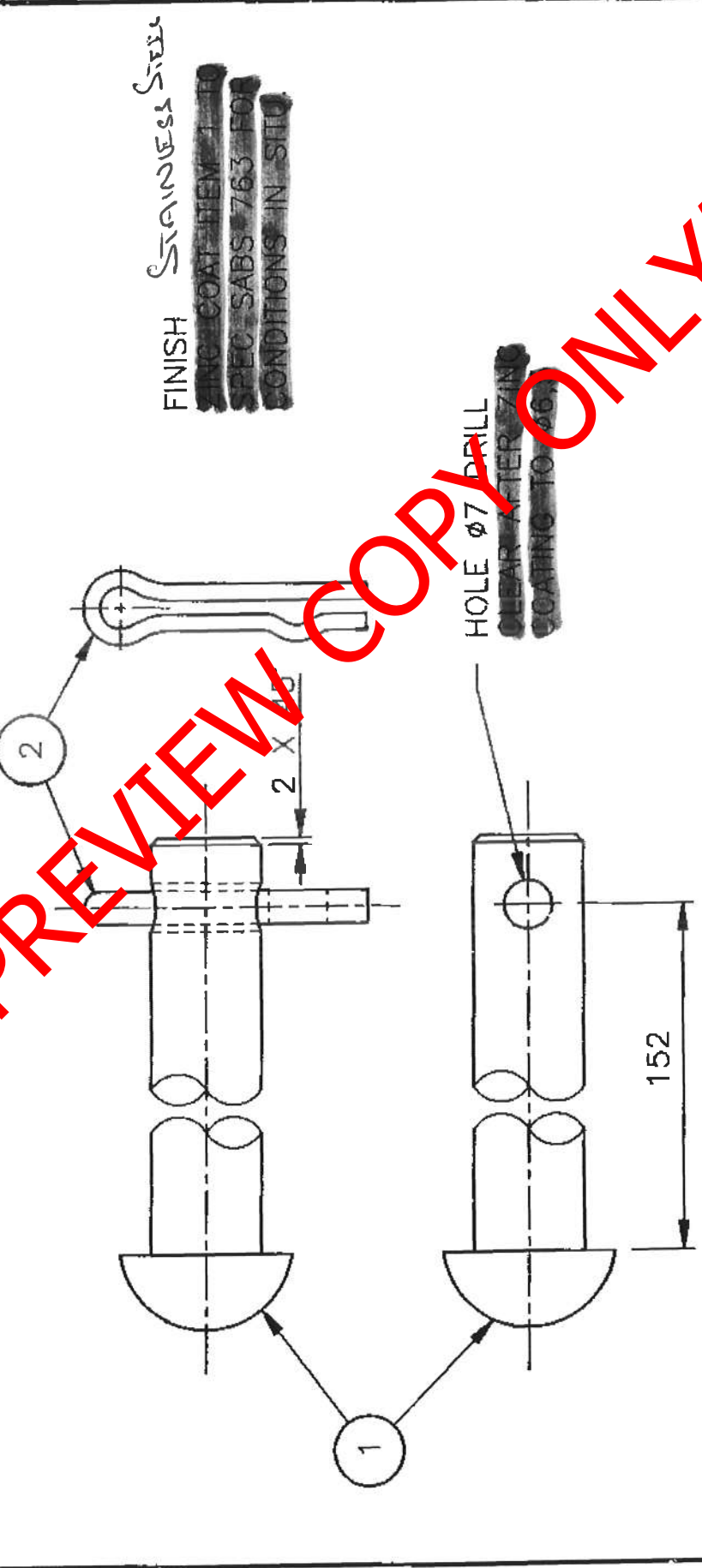

DO REF: T80/65 GEN TOL: LIN± 0,5 ANG± 1°

DRN: T HUMAN CKD:R McMILLAN DATE: 80-04-02

ENG: — GA WILLIAMS for CHIEF ENG

INFRASTRUCTURE (ELECTRICAL)

 **SPOORNET**

PIVOT PIN Ø16
WITH LOCKING SPLIT PIN