



Transnet Freight Rail, a division of

TRANSNET SOC LTD

Registration Number 1990/000900/30

[hereinafter referred to as **Transnet**]

REQUEST FOR QUOTATION [RFQ] No SAZ52492

MAINTENANCE TO THE MESS AND ABLUTION AT SALKOR

ISSUE DATE: 18 October 2013

CLOSING DATE: 29 October 2013

CLOSING TIME: 10:00



RFQ SAZ52492

SCHEDULE OF DOCUMENTS

MAINTENANCE TO THE MESS AND ABLUTION FACILITIES AT SALKOR

Section

1. Notice to Bidders
2. Quotation Form - Schedule of Quantities & Price Schedule
3. Standard Term and Conditions for the supply of Goods or services to Transnet
4. Compliance to clause document
5. Certificate of attendance
6. Vendor application document
7. General Bid Conditions – Appendix (i)
8. Standard term and conditions of contract (services) Appendix (ii)

Annexure A - Project Specifications - asset 02BA086C

Annexure B - Price List - asset 02BA086C

Annexure A - Project Specifications - asset 02BA085S

Annexure B - Price List - asset 02BA085S

Special Conditions

E4E - Safety arrangements and procedural compliance

E7/1 – document

Section 1
NOTICE TO BIDDERS

Quotations which must be completed as indicated in Section 2 of this RFQ are to be submitted as follows:

METHOD: Post or Courier
CLOSING VENUE: SEE BELOW FOR CLOSING VENUE

Proposals must reach the Secretariat, Acquisition Council before the closing hour on the date shown below, and must be enclosed in a sealed envelope which must have inscribed on the outside:

RFP No: SAZ52492
Description: MAINTENANCE TO MESS AND ABLUTION SALKOR
Closing date and time: 29 October 2013 AT 10:00
Closing address: [Refer to options in Delivery Instructions for RFQ below]

Non Refundable Deposit

On or after R150,00, the RFP documents may be inspected at and are obtainable from the office of the Secretariat, Transnet Park 6th Floor Robert Sobukwe Street, Bellville on payment of an amount of R 150,00 [inclusive of VAT] per set. Payment is to be made as follows:

Bank: Standard Bank
Account Number: 002 0315 8598
Branch: Braamfontein
Branch code: 004805
Account Name: Transnet Freight Rail
Reference: BLE / 52477

NOTES –

This amount is not refundable.

A receipt for such payment made must be presented when collecting the RFP documents and submitted thereafter with your Proposal.

All envelopes must reflect the return address of the Respondent on the reverse side.

A. DELIVERY INSTRUCTIONS FOR RFQ

Delivery by hand

If delivered by hand, the envelope is to be deposited in the Transnet tender box which is located at the main entrance of Transnet Park, ROBERT SOBUKWE Road, Bellville, and should be addressed as follows:

THE SECRETARIAT
ACQUISITION COUNCIL
TRANSNET PARK
TENDER BOX
ROBERT SOBUKWE ROAD
BELLVILLE 7535

The measurements of the "tender slot" are 400mm wide x 100mm high, and Respondents must please ensure that response documents or files are no larger than the above dimensions. Responses which are too bulky [i.e. more than 100mm thick] must be split into two or more files, and placed in separate envelopes, each such envelope to be addressed as above.

Dispatch by courier

If dispatched by courier, the envelope must be addressed as follows and delivered to the Office of The Secretariat, Acquisition Council and a signature obtained from that Office:

THE SECRETARIAT
TRANSNET ACQUISITION COUNCIL
6TH FLOOR
TRANSNET PARK
ROBERT SOBUKWE ROAD
BELLVILLE

Please note that this RFP closes punctually at **10:00 on Tuesday 29 OCTOBER 2013.**

1. If responses are not delivered as stipulated herein, such responses will not be considered and will be treated as "NON-RESPONSIVE" and will be disqualified.
2. No email or facsimile responses will be considered, unless otherwise stated herein.
3. The responses to this RFQ will be opened as soon as practicable after the expiry of the time advertised for receiving them.
4. Transnet shall not, at the opening of responses, disclose to any other company any confidential details pertaining to the Proposals / information received, i.e. pricing, delivery, etc. The names and locations of the Respondents will be divulged to other Respondents upon request.
5. Envelopes must not contain documents relating to any RFQ other than that shown on the envelope.

B. FORMAL BRIEFING

- i. A compulsory RFQ Site Meeting will be conducted at the **Precast Yard TFR Saldanha on 25 October 2013**. [Respondents to provide own transportation and to wear appropriate safety apparel].
- ii. **Respondents failing to attend the compulsory RFQ briefing will be disqualified.**

The site meeting will start PUNCTUALLY at time mentioned above and information will not be repeated

1 Responses to RFQ

Responses to this RFQ [**Quotations**] must not include documents or reference relating to any other quotation or proposal. Any additional conditions must be embodied in an accompanying letter.

2 Broad-Based Black Economic Empowerment [B-BBEE]

Transnet fully endorses and supports the Government's Broad-Based Black Economic Empowerment Programme and it would therefore prefer to do business with local business enterprises who share these same values. Transnet will accordingly allow a "preference" to companies who provide a valid B-BBEE Verification Certificate. All procurement transactions will be evaluated accordingly.

2.1 B-BBEE Scorecard and Rating

As prescribed in terms of the Preferential Procurement Policy Framework Act (PPPFA), Act 5 of 2000 and its Regulations, Respondents are to note the following:

- In this RFQ, Transnet will apply the 80/20 preference point system prescribed in the PPPFA.
- Proposals will be evaluated on price which will be allocated 80 points and preference which will be allocated 20 points.
- The 80/20 preference point system applies where the acquisition of the Services will be less than R1 000 000.00. However, if the 80/20 preference point system is stipulated in this RFQ and all Bids received exceed R1 000 000.00, the RFQ will be cancelled.

In compliance with the Government Gazette No 34612, Notice No. 754 dated 23 September 2011, as from 1 October 2011 valid B-BBEE Verification Certificates must be issued by:

- (i) Verification Agencies accredited by the South African National Accreditation System [SANAS]; or
- (ii) Registered Auditors approved by the Independent Regulatory Board of Auditors [IRBA], in accordance with the approval granted by the Department of Trade and Industry.

Enterprises will be rated by such agencies based on the following:

- a) **Large Enterprises** [i.e. annual turnover greater than R35 million]:
 - Rating level based on all seven elements of the B-BBEE scorecard
- b) **Qualifying Small Enterprises – QSE** [i.e. annual turnover between R5 million and R35 million]:
 - Rating based on any four of the elements of the B-BBEE scorecard
- c) **Exempted Micro Enterprises – EME** [i.e. annual turnover less than R5 million]:

In accordance with B-BBEE Codes of Good Practice [Statement 000, Section 4], any enterprise with an annual total revenue of R 5 million or less qualifies as an EME.

- Automatic rating of B-BBEE Level 4 irrespective of race or ownership
- Black ownership greater than 50% or Black Women ownership greater than 50% automatically qualify as B-BBEE Level 3

Sufficient evidence to qualify as an EME would be a certificate (which may be in the form of a letter) from an auditor or accounting officer or a certificate from a Verification Agency accredited by SANAS. The certificate must confirm the company's turnover, black ownership / black female ownership, B-BBEE status level and validity date.

Respondents are required to furnish proof of the above to Transnet. [i.e. a valid detailed scorecard as stipulated above in respect of Large Enterprises and QSEs, or a valid certificate in respect of EMEs].

Transnet will accordingly allocate a maximum of **20 [twenty] points** to the Respondent's final score based on an entity's B-BBEE scorecard rating. [Refer **Annexure A – B-BBEE Preference Points Claim Form** for further details].

N.B. Failure to submit a B-BBEE certificate, which is valid as at the Closing Date of this RFP, will result in a score of zero being allocated for B-BBEE.

[Refer clause 18 below for Returnable Documents required]

2.2 B-BBEE Joint Ventures, Consortiums and/or Subcontractors

In addition to the above, Respondents who would wish to enter into a Joint Venture [JV] or consortium with, or subcontract portions of the contract to, B-BBEE entities, must state in their RFPs the percentage of the total contract value that would be allocated to such B-BBEE entities, should they be successful in being awarded any business. A valid B-BBEE Verification Certificate in respect of such B-BBEE JV or consortium partners and/or subcontractor(s), as well as a breakdown of the distribution of the aforementioned percentage must also be furnished with the RFP Bid to enable Transnet to evaluate in accordance with the processes outlined in the B-BBEE Preference Points Claim Form appended hereto as Section 14.

(i) JVs or Consortiums

If contemplating a JV or consortium, Respondents should also submit a signed JV or consortium agreement between the parties clearly stating the percentage [%] split of business and the associated responsibilities of each party. If such a JV or consortium agreement is unavailable, the partners must submit confirmation in writing of their intention to enter into a JV or consortium agreement should they be awarded business by Transnet through this RFP process. This written confirmation must clearly indicate the percentage [%] split of business and the responsibilities of each party. In such cases, award of business will only take place once a signed copy of a JV or consortium agreement is submitted to Transnet.

(i) Incorporated JVs/Consortiums

As part of an incorporated JV/consortium's Bid response, the incorporated JV/consortium must submit a valid B-BBEE Verification Certificate in its registered name.

(ii) Unincorporated JVs/Consortiums

As part of an unincorporated JV/consortium's tendered response, the unincorporated JV/consortium must submit a consolidated B-BBEE certificate as if it was a group structure and such scorecard must have been prepared for this RFP in particular.

N.B. Failure to submit a B-BBEE certificate in respect of the JV or Consortium, which is valid as at the Closing Date of this RFP, will result in a score of zero being allocated for B-BBEE.

(ii) Subcontracting

If contemplating subcontracting, please note that a Respondent will not be awarded points for B-BBEE if it is indicated in its Proposal that such Respondent intends subcontracting more than 25% [twenty-five per cent] of the value of the contract to an entity that does not qualify for at least the same points that the Respondent qualifies for, unless the intended subcontractor is an EME with the capability to execute the contract.

A person awarded a contract may not subcontract more than 25% [twenty-five per cent] of the value of the contract to any other enterprise that does not have an equal or higher B-BBEE status level than the person concerned, unless the contract is subcontracted to an EME that has the capability and ability to execute the subcontract.

2.3 Subcontracting:

Will any portion of the contract be subcontracted? YES/NO [delete which is not applicable]

If YES, indicate:

- (i) What percentage of the contract will be subcontracted?%
- (ii) The name of the subcontractor
- (iii) The B-BBEE status level of the subcontractor
- (iv) Is the subcontractor an EME? YES/NO

2.4 Declaration with regard to Company/Firm

- (i) Name of Company/Firm.....
 - (ii) VAT registration number.....
 - (iii) Company registration number.....
 - (iv) Type of Company / Firm
 - Partnership/Joint Venture/Consortium
 - One person business/sole propriety
 - Close Corporations
 - Company (Pty) Ltd
- [TICK APPLICABLE BOX]

(v) Describe Principal Business Activities

.....
.....
.....
.....
.....

(vi) Company Classification

- Manufacturer
 - Supplier
 - Professional Service Provider
 - Other Service Providers, e.g Transporter, etc
- [TICK APPLICABLE BOX]

(vii) Total number of years the company/firm has been in business.....

3 Communication

- a) Respondents are warned that a response will be liable for disqualification should any attempt be made by a Respondent either directly or indirectly to canvass any officer(s) or employee of Transnet in respect of this RFQ between the closing date and the date of the award of the business.
- b) A Respondent may, however, before the closing date and time, direct any written enquiries relating to the RFQ to the following Transnet employee:
Name: Cobus Carstens
Email: Cobus.Carstens@transnet.net
- c) Respondents may also, at any time after the closing date of the RFQ, communicate with Carol Swan or Johanna Kotze on any matter relating to its RFQ response:
Email: Johanna.kotze@transnet.net or Carol.swan@transnet.net

4 Tax Clearance

The Respondent's **original valid** Tax Clearance Certificate must accompany the Quotation. Failure to provide this document with the RFQ submission may result in disqualification.

5 VAT Registration

The valid VAT registration number must be stated here: _____ [if applicable].

6 Legal Compliance

The successful Respondent shall be in full and complete compliance with any and all applicable national and local laws and regulations.

Respondent's Signature

Date & Company Stamp

7 Changes to Quotations

Changes by the Respondent to its submission will not be considered after the closing date and time.

8 Pricing

All prices must be quoted in South African Rand on a fixed price basis, excluding VAT.

9 Prices Subject to Confirmation

Prices quoted which are subject to confirmation will not be considered.

10 Negotiations

Transnet reserves the right to undertake post-tender negotiations with selected Respondents or any number of short-listed Respondents.

11 Binding Offer

Any Quotation furnished pursuant to this Request shall be deemed to be an offer. Any exceptions to this statement must be clearly and specifically indicated.

12 Disclaimers

Transnet is not committed to any course of action as a result of its issuance of this RFQ and/or its receipt of a Quotation in response to it. Please note that Transnet reserves the right to:

- modify the RFQ's goods / service(s) and request Respondents to re-bid on any changes;
- reject any Quotation which does not conform to instructions and specifications which are detailed herein;
- disqualify Quotations submitted after the stated submission deadline;
- not necessarily accept the lowest priced Quotation;
- reject all Quotations, if it so decides;
- place an order in connection with this Quotation at any time after the RFQ's closing date;
- award only a portion of the proposed goods / service/s which are reflected in the scope of this RFQ;
- split the award of the order/s between more than one Supplier/Service Provider; or
- make no award at all.

In addition, Transnet reserves the right to exclude any Respondent from the bidding process who has been convicted of a serious breach of law during the preceding 5 [five] years, including but not limited to breaches of the Competition Act 89 of 1998. Respondents are required to indicate below whether or not they have been found guilty of a serious breach of law during the past 5 [five] years:

I/We _____ do hereby certify that *I/we have/have not been* found guilty during the preceding 5 [five] years of a serious breach of law, including but not limited to a breach of the Competition Act, 89 of 1998, by a court of law, tribunal or other administrative body. The type of breach that the Respondent is required to disclose excludes relatively minor offences or misdemeanours, e.g. traffic offences.

Where found guilty of such a serious breach, please disclose:

NATURE OF BREACH:

DATE OF BREACH: _____

Furthermore, I/we acknowledge that Transnet SOC Ltd reserves the right to exclude any Respondent from the bidding process, should that person or entity have been found guilty of a serious breach of law, tribunal or regulatory obligation.

13 Evaluation Criteria

Transnet will utilise the following criteria [not necessarily in this order] in choosing a Supplier/Service Provider, if so required:

- **Administrative responsiveness** - Completeness of response and returnable documents
- **Substantive responsiveness** – Prequalification criteria, if any, must be met and whether the Bid materially complies with the scope and/or specification given.

Preference points will be awarded to a bidder for attaining the B-BBEE status level of contribution in accordance with the table below:

B-BBEE Status Level of Contributor	Number of points (80/20 system)
1	20
2	18
3	16
4	12
5	8
6	6
7	4
8	2
Non-compliant contributor	0

14 Validity Period

Transnet desires a validity period of 60 [sixty] days from the closing date of this RFQ.

This RFQ is valid until _____.

15 Banking Details

BANK: _____

BRANCH NAME / CODE: _____

ACCOUNT HOLDER: _____

ACCOUNT NUMBER: _____

16 Company Registration

Registration number of company / C.C. _____

Respondent's Signature

Date & Company Stamp

Registered name of company / C.C. _____

17 Disclosure of Prices Quoted

Respondents must indicate here whether Transnet may disclose their quoted prices and conditions to other Respondents:

YES NO

18 Returnable Documents

Returnable Documents means all the documents, Sections and Annexures, as listed in the tables below.

- a) Respondents are required to submit with their Quotations the **Returnable Documents**, as detailed below.

Failure to provide all these Returnable Documents at the Closing Date and time of this RFQ may result in a Respondent's disqualification. Respondents are therefore urged to ensure that all these Documents are returned with their Quotations.

All Sections, as indicated in the footer of each page, must be signed, stamped and dated by the Respondent. Please confirm submission of these Returnable Documents by so indicating [Yes or No] in the table below:

Returnable Documents	Submitted [Yes or No]
SECTION 1 : Notice to Bidders	
- Valid B-BBEE Verification Certificate [RSA Large Enterprises and QSEs] Note: failure to provide a valid B-BBEE Verification Certificate at the closing date and time of the tender will result in an automatic score of zero being allocated for B-BBEE scorecard	
- Valid B-BBEE certificate from auditor, accounting officer or SANAS accredited Verification Agency [RSA EMEs] Note: failure to provide a valid B-BBEE Verification Certificate at the closing date and time of the tender will result in an automatic score of zero being allocated for B-BBEE scorecard	
- In the case of Joint Ventures, a copy of the Joint Venture Agreement or written confirmation of the intention to enter into a Joint Venture Agreement	
SECTION 2 : Quotation Form	
SECTION 3: Vendor Application Form	
• Original cancelled cheque or bank verification of banking details	
• Certified copies of IDs of shareholder/directors/members [as applicable]	
• Certified copy of Certificate of Incorporation [CM29/CM9 name change]	
• Certified copy of share certificates [CK1/CK2 if C.C.]	
• Entity's letterhead	
• Certified copy of VAT Registration Certificate [RSA entities only]	
• Certified copy of valid Company Registration Certificate [if applicable]	

Respondent's Signature _____

Date & Company Stamp _____

Returnable Documents	Submitted [Yes or No]
• Original valid Tax Clearance Certificate [Consortia / Joint Ventures must submit a separate Tax Clearance Certificate for each party]	
• Letter of Good Standing	
• Price Schedules B (i) and B (ii)	
• Section 4: CERTIFICATE OF ACQUAINTANCE WITH SPECIFICATIONS	
• Section 5: CERTIFICATE OF ATTENDANCE OF SITE MEETING	
• Letter of Good Standing	

"PREVIEW COPY ONLY"

Respondent's Signature

Date & Company Stamp

Section 2 QUOTATION FORM

I/We _____
hereby offer to supply the goods/services at the prices quoted in the Price Schedule below, in accordance with the conditions related thereto.

I/We agree to be bound by those terms and conditions in:

- the Standard Terms and Conditions for the Supply of Goods or Services to Transnet [available on request]; and
- any other standard or special conditions mentioned and/or embodied in this Request for Quotation.

I/We accept that unless Transnet should otherwise decide and so inform me/us, this Quotation [and, if any, its covering letter and any subsequent exchange of correspondence], together with Transnet's acceptance thereof shall constitute a binding contract between Transnet and me/us.

I/We further agree that if, after I/we have been notified of the acceptance of my/our Quotation, I/we fail to deliver the said goods/service/s within the delivery lead-time quoted, Transnet may, without prejudice to any other legal remedy which it may have, cancel the order and recover from me/us any expenses incurred by Transnet in calling for Quotations afresh and/or having to accept any less favourable offer.

Price Schedule

I/We quote as follows for the services, excluding VAT: **(Totals from Annexure B- 02BA086C and Annexure B – 02BA085S to be inserted below)**

Description of Services	Total Price (ZAR)
Total price – ASSET 02BA086C (excl. VAT)	
Total price - ASSET 02BA085S (excl. VAT)	
Total	

Notes to Pricing:

- a) All Prices must be quoted in South African Rand, exclusive of VAT
- b) To facilitate like-for-like comparison bidders must submit pricing strictly in accordance with the attached Pricing Schedule (**Annexures B assets 02BA085C & 02BA086C**) and not utilise a different format. Deviation from this pricing schedule could result in a bid being disqualified.
- c) Please note that should you have offered a discounted price(s), Transnet will only consider such price discount(s) in the final evaluation stage if offered on an unconditional basis.

Respondent's Signature _____

Date & Company Stamp _____

REFERENCES

Please indicate below the company names and contact details of customers whom Transnet may contact to seek third party evaluations of your current service levels:

Previous Civil Projects / Work of the same value :

NAME OF COMPANY	CONTACT PERSON	TELEPHONE

"PREVIEW COPY ONLY"

Respondent's Signature

Date & Company Stamp

Section 3

STANDARD TERMS AND CONDITIONS FOR THE SUPPLY OF GOODS OR SERVICES TO TRANSNET

A Supplier/Service Provider shall be obliged to adhere to the Standard Terms and Conditions for the Supply of Goods and Services to Transnet as expressed hereunder. Should the Respondent find any condition(s) unacceptable, it should indicate which condition(s) is/are unacceptable and offer an alternative(s). A Quotation submitted by a Respondent will be subjected to review and acceptance or rejection of its proposed contractual terms and conditions by Transnet's Legal Counsel, prior to consideration for an award of business.

1 SOLE AGREEMENT

Unless otherwise agreed in writing, these terms [**Terms** and each **Term**] and Transnet's purchase order(s) [**Order** or **Orders**] represent the only conditions upon which Transnet SOC Ltd [**Transnet**] procures goods [**the Goods**] or services [**the Services**] specified in the Order from the person to whom the Order is addressed [**the Supplier/Service Provider**]. Transnet does not accept any other conditions which the Supplier/Service Provider may specify, unless otherwise agreed to by Transnet in writing. In the event of any inconsistency between these Terms and any Order, these Terms shall take precedence.

2 CONFORMITY WITH ORDER

Goods/Services shall conform strictly with the Order. The Supplier/Service Provider shall not vary the quantities specified and/or the specification, if any, stipulated in the Order, without the prior written consent of Transnet. The Supplier/Service Provider warrants that the Goods/Services shall be fit for their purpose and of satisfactory quality.

3 DELIVERY AND TITLE

- 3.1 The delivery dates and addresses are those in the Order. Time shall be of the essence in respect of the Supplier's/Service Provider's obligations under the Order.
- 3.2 The Supplier/Service Provider will not be excused for delay in delivery or performance except due to circumstances outside its control and then only subject to the Supplier/Service Provider having notified Transnet in writing on becoming aware of such circumstances. Transnet may terminate an Order, in whole or in part, without incurring any liability to the Supplier/Service Provider if such a delay becomes, in Transnet's absolute opinion, significant.
- 3.3 If on delivery, the Goods/Services do not conform to the Order, Transnet may reject the Goods/Services and the Supplier/Service Provider shall promptly rectify any defects or in Transnet's opinion, supply appropriate replacement Goods/Services at the Supplier's/Service Provider's expense within the specified delivery times, without any liability due by Transnet

4 PRICE AND PAYMENT

- 4.1 Prices specified in an Order cannot be increased. Payment for the Goods/Services shall be made by Transnet against an original undisputed invoice(s) [a Tax Invoice], supporting documentation and month-end statement from the Supplier/Service Provider. Tax Invoices plus supporting documentation shall be posted to the address shown in the Order.

4.2 Payment of the Supplier's/Service Provider's valid Tax Invoice(s) will be made by Transnet in the South African currency and on the terms stated in the Order, the standard payment terms being 30 [thirty] days from date of receipt by Transnet of a month-end statement, unless otherwise agreed to in writing. Transnet shall arrange for payment of such Tax Invoices and any pre-authorised additional expenses incurred, provided that the authorised expenses are supported by acceptable documentary proof of expenditure incurred [where this is available]. Any amounts due in terms of these Terms shall be paid to the Supplier/Service Provider, taking into account any deduction or set-off and bank charges.

5 PROPRIETARY RIGHTS LIABILITY

If any allegations should be made or any claim asserted against Transnet that ownership of, or any act or omission by Transnet in relation to Goods/Services or any written material provided to Transnet relating to any Goods/Services or pursuant to an Order being a violation or infringement of any third party's contractual, industrial, commercial or intellectual property rights including but not limited to any patent, registered design, design right, trade mark, copyright or service mark on any application thereof, the Supplier/Service Provider hereby indemnifies Transnet against and hold it harmless from any and all losses, liabilities, costs, claims, damages and expenses [including any legal fees] arising directly or indirectly from such allegation or claim provided that this indemnity shall not apply where the allegation or claim arises solely as a result of the Supplier/Service Provider following a design or process originated and furnished by Transnet. The Supplier/Service Provider shall either

- a) procure for Transnet the right to continue using the infringing Goods; or
- b) modify or replace the Goods/Services so that they become non-infringing,

provided that in both cases the Goods/Services shall continue to meet Transnet's requirements and any specifications stipulated in the Order. Should neither option be possible, the Supplier/Service Provider may remove, with Transnet's prior written consent, such Goods/Services and will pay to Transnet a sum equivalent to the purchase price. If Transnet refuses to give such consent, the Supplier/Service Provider shall have no liability in respect of any continued use of the infringing Goods/Services after Supplier's/Service Provider's prior written request to remove the same.

6 PROPRIETARY INFORMATION

All information which Transnet has divulged or may divulge to the Supplier/Service Provider and any information relating to Transnet's business which may have come into the Supplier's/Service Provider's possession whilst carrying out an Order, and the existence of the Order, shall be treated by the Supplier/Service Provider as confidential information and shall not, without Transnet's prior written consent, be disclosed to any third party, or be used or copied for any purposes other than to perform the Order. This clause does not apply to information which is public knowledge or available from other sources other than by breach of this Term. Upon request by Transnet, the Supplier/Service Provider shall return all materials issued pursuant to the Order and, pending this, shall protect Transnet's rights in any such materials. Such confidential information shall at all material times be the property of Transnet.

7 PUBLICITY

The Supplier/Service Provider shall not name Transnet or use its trademarks, service marks [whether registered or not] or Goods in connection with any publicity without Transnet's prior written consent.

8 TERMINATION OF ORDER

- 8.1 Transnet may cancel an Order in whole or in part at any time upon at least 7 [seven] days' written notice to the Supplier/Service Provider, or when there is a change in control of the Supplier/Service Provider or the Supplier/Service Provider commits any serious breach or any repeated or continued material breach of its obligations under these Terms and/or Order or shall have been guilty of conduct tending to bring itself into disrepute, on written notice to the Supplier/Service Provider when such work on the Order shall stop.
- 8.2 Transnet shall pay the Supplier/Service Provider a fair and reasonable price for justified work in progress, where such price reflects only those costs not otherwise recoverable by the Supplier/Service Provider, at the time of termination, and the Supplier/Service Provider shall give Transnet full assistance to check the extent of such work in progress. Payment of such price shall be in full and final satisfaction of any claims arising out of such termination and upon such payment the Supplier/Service Provider shall deliver to Transnet all work, including any materials, completed or in progress. The sum payable to the Supplier/Service Provider under this clause will not in any event exceed the total amount that would have been payable to the Supplier/Service Provider had the Order not been terminated.
- 8.3 In the event of termination the Supplier/Service Provider must submit all claims within 2 [two] months of termination after which time claims will only be met in what Transnet considers exceptional circumstances.
- 8.4 If the Goods or Services are not provided in accordance with an Order, the Order shall be deemed terminated and the Supplier/Service Provider shall compensate Transnet for any costs incurred in obtaining substitute Goods or any damage caused due to the failure or delay in the delivery.

9 ACCESS

The Supplier/Service Provider shall be liable for the acts, omissions and defaults of its personnel or agents who, for the purposes of the Order, shall be treated as if they are the Supplier's/Service Provider's employees. The Supplier/Service Provider shall ensure that any such personnel or agents, whilst on Transnet's premises, shall comply with Transnet's health and safety, security and system security rules and procedures as and where required.

10 WARRANTY

The Supplier/Service Provider warrants that it is competent to supply the Services in accordance with these Terms to the reasonable satisfaction of Transnet and that all Services delivered under the Order: (a) conform and comply in all relevant legislation, standards, directives and orders related to [inter alia] the Services in force at the time of delivery, and to any specifications referred to in the Order; (b) will not cause any deterioration in the functionality of any Transnet equipment; and (c) do not infringe any third party rights of any kind. The Supplier/Service Provider hereby indemnifies Transnet against all losses, liabilities, costs, claims, damages, expenses and awards of any kinds incurred or made against Transnet in connection with any breach of this warranty.

11 INSOLVENCY

If the Supplier/Service Provider shall have a receiver, manager, administrator, liquidator or like person appointed over all or any part of its assets or if the Supplier/Service Provider compounds with its creditors or passes a resolution for the writing up or administration of the Supplier/Service Provider, Transnet is at liberty to terminate the Order or Orders forthwith, or at its option, to seek performance by any such appointed person.

12 ASSIGNMENT

The Supplier/Service Provider shall not assign its obligations under an Order without Transnet's prior written consent, which consent shall not be unreasonably withheld or delayed.

13 NOTICES

Notices under these Terms shall be delivered by hand to the relevant addresses of the parties in the Order or may be served by facsimile or by email, in which event notice shall be deemed served on acknowledgement of receipt by the recipient.

14 LAW

Orders shall be governed by and interpreted in accordance with South African law and any disputes arising herein shall be subject to South African arbitration under the rules of the Arbitration Foundation of South Africa, which rules are deemed incorporated by reference in this clause. The reference to arbitration shall not prevent Transnet referring the matter to any South African courts, having jurisdiction, to which the Supplier/Service Provider hereby irrevocably submits but without prejudice to Transnet's right to take proceedings against the Supplier/Service Provider in other jurisdictions and/or obtaining interim relief on an urgent basis from a court of competent jurisdiction pending the decision in other courts or from instituting in any court of competent jurisdiction any proceedings for an interdict or any other injunctive relief. If the Supplier/Service Provider does not have a registered office in the South Africa it will at all times maintain an agent for service of process in South Africa and shall give Transnet the name and address of such agent as such may be amended, in writing, from time to time.

15 GENERAL

Completion or termination of an Order shall be without prejudice to any Term herein which by its nature would be deemed to continue after completion or termination. Headings are included herein for convenience only. If any Term herein be held illegal or unenforceable, the validity or enforceability of the remaining Terms shall not be affected. No failure or delay by Transnet to enforce any rights under these Terms will operate as a waiver thereof by Transnet. All rights and remedies available to either party under these Terms shall be in addition to, not to the exclusion of, rights otherwise available at law.

16 COUNTERPARTS

These Terms and conditions may be signed in any number of counterparts, all of which taken together shall constitute one and the same instrument. Any party may enter into this agreement by signing any such counterpart.

By signing this RFQ document, the Respondent is deemed to acknowledge that he/she has made himself/herself thoroughly familiar with all the conditions governing this RFQ, including those contained in any printed form stated to form part hereof and Transnet SOC Ltd will recognise no claim for relief based on an allegation that the Respondent overlooked any such condition or failed to properly take it into account for the purpose of calculating quoted prices or otherwise.

SIGNED at _____ on this _____ day of _____ 20____

.....
SIGNATURE OF RESPONDENT'S AUTHORISED REPRESENTATIVE

NAME: _____

DESIGNATION: _____

REGISTERED NAME OF COMPANY: _____

PHYSICAL ADDRESS: _____

Respondent's contact person: *[Please complete]*

Name	:	
Designation	:	
Telephone	:	
Cell Phone	:	
Facsimile	:	
Email	:	
Website	:	

**Transnet urges its clients, suppliers and the general public to report any fraud or corruption to
TIP-OFFS ANONYMOUS : 0800 003 056**

Respondent's Signature

Date & Company Stamp

Section 4: CERTIFICATE OF ACQUAINTANCE WITH SPECIFICATIONS

I/We

_____ do hereby certify that I/we acquainted myself/ourselves with all the documentation comprising the Specifications for the carrying out of the proposed Services for which I/we submitted my/our Proposal.

I/We furthermore agree that Transnet SOC Ltd shall recognise no claim from me/us for relief based on an allegation that I/we overlooked any provisions of the Specifications or failed to take it into account for the purpose of calculating my/our offered prices or otherwise.

I/We confirm having been advised that a signed copy of this Schedule can be submitted in lieu of the Specifications as confirmation in terms of the Returnable Schedule.

SIGNED at _____ on this _____ day of _____ 20____

SIGNATURE OF WITNESS

SIGNATURE OF RESPONDENT

"PREVIEW COPY ONLY"

Section 5:

CERTIFICATE OF ATTENDANCE OF SITE BRIEFING – RFQ SAZ52492

It is hereby certified that –

1. _____

2. _____

Representative(s) of _____ *[name of entity]*

attended the RFP briefing in respect of the proposed Services to be rendered in terms of this RFP on _____ 20__

TRANSNET'S REPRESENTATIVE

RESPONDENT'S REPRESENTATIVE

DATE _____

DATE _____

EMAIL _____

"PREVIEW COPY ONLY"

Section 6:

VENDOR APPLICATION FORM

"PREVIEW COPY ONLY"

Respondent's Signature

Date & Company Stamp



Transnet Supplier Declaration/Application

The Financial Director or Company Secretary

Transnet Vendor Management has received a request to load your company on to the Transnet vendor database. Please furnish us with the following to enable us to process this request:

1. Complete the "Supplier Declaration Form" (SDF) on page 2 of this letter
2. **Original** cancelled cheque **OR** letter from the bank verifying banking details (**with bank stamp**)
3. **Certified** copy of Identity document of Shareholders/Directors/Members (where applicable)
4. **Certified** copy of certificate of incorporation, CM29 / CM9 (name change)
5. **Certified** copy of share Certificates of Shareholders, CK1 / CK2 (if CC)
6. A letter with the company's letterhead confirming physical and postal addresses
7. **Original** or **certified** copy of SARS Tax Clearance certificate and Vat registration certificate
8. A signed letter from the Auditor / Accountant confirming most recent annual turnover and percentage black ownership in the company **AND/OR** BBBEE certificate and detailed scorecard from an accredited rating agency (SANAS member).

NB:

- **Failure to submit the above documentation will delay the vendor creation process.**
- *Where applicable, the respective Transnet business unit processing your application may request further information from you. E.g. proof of an existence of a Service/Business contract between your business and the respective Transnet business unit etc.*

IMPORTANT NOTES:

- a) **If your annual turnover is less than R5 million**, then in terms of the DTI codes, you are classified as an Exempted Micro Enterprise (EME). If your company is classified as an EME, please include in your submission, a signed letter from your Auditor / Accountant confirming your company's most recent annual turnover is less than R5 million and percentage of black ownership and black female ownership in the company **AND/OR** BBBEE certificate and detailed scorecard from an accredited rating agency (e.g. permanent SANAS Member), should you feel you will be able to attain a better BBBEE score.
- b) **If your annual turnover is between R5 million and R35million**, then in terms of the DTI codes, you are classified as a Qualifying Small Enterprise (QSE) and you claim a specific BBBEE level based on any 4 of the 7 elements of the BBBEE score-card, please include your BEE certificate in your submission as confirmation of your status.
NB: BBBEE certificate and detailed scorecard should be obtained from an accredited rating agency (e.g. permanent SANAS Member).
- c) **If your annual turnover is in excess of R35million**, then in terms of the DTI codes, you are classified as a Large Enterprise and you claim a specific BEE level based on all seven elements of the BBBEE generic score-card. Please include your BEE certificate in your submission as confirmation of your status.
NB: BBBEE certificate and detailed scorecard should be obtained from an accredited rating agency (permanent SANAS Member).
- d) **To avoid PAYE tax being automatically deducted from any invoices received from you**, you must also contact the Transnet person who lodged this request on your behalf, so as to be correctly classified in terms of Tax legislation.
- e) Unfortunately, **No payments can be made to a vendor** until the vendor has been registered, and no vendor can be registered until the vendor application form, together with its supporting documentation, has been received and processed.
- f) Please return the completed Supplier Declaration Form (SDF) together with the required supporting documents mentioned above to the Transnet Official who is intending to procure your company's services/products in order that he/she should complete and Internal Transnet Departmental Questionnaire before referring the matter to the appropriate Transnet Vendor Master Office.

Regards,

Transnet Vendor/Supplier Management .Contact person Carol tell: 021 940-3846 fax 021 940-3883.



Supplier Declaration Form

Company Trading Name						
Company Registered Name						
Company Registration Number Or ID Number If A Sole Proprietor						
Form of entity	CC	Trust	Pty Ltd	Limited	Partnership	Sole Proprietor
VAT number (if registered)						
Company Telephone Number						
Company Fax Number						
Company E-Mail Address						
Company Website Address						
Bank Name			Bank Account Number			
Postal Address						Code
Physical Address						Code
Contact Person						
Designation						
Telephone						
Email						
Annual Turnover Range (Last Financial Year)		< R5 Million	R5-35 million	> R35 million		
Does Your Company Provide		Products	Services	Both		
Area Of Delivery		National	Provincial	Local		
Is Your Company A Public Or Private Entity			Public	Private		
Does Your Company Have A Tax Directive Or IRP30 Certificate			Yes	No		
Main Product Or Service Supplied (E.G.: Stationery/Consulting)						

BEE Ownership Details

% Black Ownership	% Black women ownership	% Disabled person/s ownership	
Does your company have a BEE certificate	Yes	No	
What is your broad based BEE status (Level 1 to 9 / Unknown)			
How many personnel does the firm employ		Permanent	Part time

Transnet Contact Person	
Contact number	
Transnet operating division	

Duly Authorised To Sign For And On Behalf Of Firm / Organisation

Name	Designation
Signature	Date

Stamp And Signature Of Commissioner Of Oath

Name	Date
Signature	Telephone No.

NB: Please return the completed Supplier Declaration Form (SDF) together with the required supporting documents mentioned above to the Transnet Official who is intending to procure your company's services/products.

Transnet Vendor/Supplier Management .Contact person Carol tell: 021 940-3846 fax 021 940-3883

Section 7:

GENERAL BID CONDITIONS - APPENDIX (i) SERVICES

This document is not attached, but is available on request.

"PREVIEW COPY ONLY"

Section 8:

**STANDARD TERMS AND CONDITIONS OF CONTRACT FOR THE PROVISION OF
SERVICES TO TRANSNET - APPENDIX (ii)**

This document is not attached, but is available on request.

"PREVIEW COPY ONLY"

ANNEXURE A

ASSET DESCRIPTION: Mess room

ASSET LOCATION: Saldanha yard

CITY / TOWN: Saldanha

WORK DESCRIPTION: Maintenance to messroom

TENDER NO: SAZ/52492

ASSET NO: 02BA086C

ITEM NO. SPECIFICATIONS PER ITEM.

CEILINGS

- 5 Work description: Break out ceiling boards, only leave brandering.
Break out ceiling boards, inspect brandering and contact project manager if any section of brandering needs replacing. Remove all clout nails or any other nails that were used to fix boards and where necessary fix loose brandering. Line up brandering in straight line.
- 8 Work description: Fit PVC ceiling complete, exclude brandering.
The ceiling board must always be fixed with the length of the board at right angles to the brandering. Boards shall be secured at 150mm centres with 25mm galvanised chipboard screws.

WALLS INTERIOR

- 68 Work description: Paint Rhino lite plaster
Cover coats. Industry norm is that a raw wall requires 3 cover coats for a fully decorated monolithic surface. For Rhino Lite use plaster primer plus two coats of general paint. However, if bonding liquid is used, 3 additional cover coats are still required as bonding liquid is clear and not a cover coat.
- 73 Work description: Paint include peperation of Knotty pine type wall finish
Wash wall thoroughly with hot water and sugar soap in order to remove any traces of dust, fat, oil and any other dirt, preparation of walls shall include opening all fine cracks with sharp object, the fill of crack and all holes in wall with the appropriate filler or patching plaster depending on the size of the cracks or holes. The areas under repair must be sand down to a smooth, even finish. Brush down the surface removing all loose particles and dust ensuring that the surface is sound. Sand paint on walls to provide bond for new paint. Rinse wall thoroughly with clean water. No sweeping or dusting shall be done after the wall had been prepare for painting or while painting is in progress or while paint is still wet. Let wall dry completely before any paint is applied.
All paint work shall be done to the specification of the manufacturer. Over coating shall be done as specified by the manufacturer. All surfaces not being painted, such as brickwork, sills, floors, joinery work and the like must be covered up and protected against spotting before any painting is commenced with. No sweeping or dusting shall be done while painting is in progress or while paint is still wet. All items that are more cost effective to remove from wall and to re-fix must be removed to avoid cutting in against items, such as notice boards, towel rails and other such items.
- 123 Work description: Install dry-wall partition
Supply and install Rhino drywall system Number one 63.5mm Drywall steel stud, Non load bearing 12,5mm Rhino wallboard, one layer each side, fix to steel stud with 25mm Dry-wall screws. All joints finished with Rhino joint tape and Rhino glide. Joint shall be neat and shall be flush with board. All work shall be done according to the manufacture specifications.

DOORS/SECURITY GATES

Respondent's signature: _____ **Date:** ____/____/____

ITEM NO. SPECIFICATIONS PER ITEM.

- 287 Work description: Paint door complete, 2 coats.
Previously painted doors: Wash thoroughly with a suitable detergent to remove all dirt and rinse with clean water. Remove defective paint/varnish and repair all holes and defective places with a suitable wood filler. Remove handle, Sand complete door and wipe off all sanding dust with a damp cloth. Allow to dry and apply one coat universal undercoat and two coat finishing paint as per work list. Let dry re fit handles. New doors to be painted: Remove lock and handles. Sand smooth and wipe sanding dust off with damp cloth. Allow to dry and apply one coat wood primer, one coat universal undercoat and two coats finishing paint as per work list. Allow paint to dry between coats as per specification. Re-fit lock and handles when paint is dry.
- 288 Work description: Varnish double doors complete, 2 coats.
Previously varnished doors: Remove handles, wash thoroughly with a suitable detergent to remove all dirt and rinse with clean water. Remove defective varnish and repair all holes and defective places with a suitable wood filler. Sand complete door and wipe off all sanding dust with a damp cloth. Allow to dry and apply two coats of varnish on varnished doors. Re-fit door handles
New doors to be varnished: Remove lock and door handles, Fill all defective places with suitable wood filler, sand smooth and wipe sanding dust off with damp cloth. Allow to dry and apply. Apply three coats varnish on doors. Allow varnish to dry between coats. Re-fit lock and handles.
- 303 Work description: Security gate spot prime and paint 2 coats.
Remove all defective paint and rust, sand completely and wipe off all sanding dust with a damp cloth. Spot prime any bare metal areas with Dulux, Plascon or approved anti rust primer. Apply Plascon, Dulux or approved universal undercoat and one coat Plascon, Dulux or approved gloss enamel.

DOORFRAMES

- 329 Work description: Paint frame complete 2 coats.
Previously painted wooden door frame: Wash thoroughly with a suitable detergent to remove all dirt, rinse with clean water. Remove defective paint/varnish and repair all holes and defective places with a suitable wood filler. Sand complete frame and wipe off all sanding dust with a damp cloth. Allow too dry and apply one coat universal and two coat finishing paint as per work list. Previously painted steel doorframes: Clean door frame from all rust and dirt by means of scraping, steel wire brush or sanding. Sand frame complete and wipe off all sanding dust with damp cloth. Allow too dry. Spot prime all exposed metal surfaces with an approved metal primer. Apply one coat universal undercoat and two coats finishing paint as per work list. New wooden door frames to be painted/varnished: Sand smooth, wipe sanding dust off with damp cloth, allow to dry and apply one coat wood primer, one coat universal undercoat and two finishing coats as per work list. As allow paint to dry between coats.
- 332 Work description: Varnish single doorframe with fan light, complete 2 coats.
Previously varnished wooden door frames: Wash thoroughly with a suitable detergent to remove all dirt, rinse with clean water. Remove defective varnish and repair all holes and defective places with a suitable wood filler. Sand complete frame and wipe off all sanding dust with a damp cloth. Allow too dry and apply two coats of varnish. New wooden door frames to be varnished: Sand smooth, use damp cloth to wipe off sanding dust, allow to dry, apply three coats varnish to door frame. As per specification, allow varnish to dry between coats.

FLOORS

Respondent's signature: _____ Date: ____/____/____

ITEM NO. SPECIFICATIONS PER ITEM.

- 365 Work description: Chip 80% and provide key coat on floor for ceramic tiles.
Chip floor to 80%. Before tiling, clean floor, apply Tylon (Tylon key it mixed with Tylon plaskey) or Tal primer and keying agent for use on smooth surfaces. Mix and apply primer and keying agent as per the manufacture specifications on container on how to mix and apply the key coat)
- 366 Work description: Lay first grade ceramic tiles on floor.
*BEFORE TILING COMMENCES, THE REPRESENTATIVE MUST FIRST APPROVE THE SURFACE, IN SITE BOOK.*ALL TILES THAT SOUND HOLLOW SHALL BE REMOVED AND RE-FIXED. ***USE ONLY TYLON WB11, TAL PROFESSIONAL ADHESIVE OR TYPE APPROVED BY PROJECT MANAGER. ***NEVER USE SPOT OR BLOB METHODS.***NEVER BUT JOINT TILES. Thoroughly clean surfaces before any tiling commences. Smooth or painted surfaces must be chipped to 80% of area. KEY IT from TAL or TYLON must be applied over whole area. Glazed floor tiles shall comply with (SABS 1449). Tiles shall be even in shape and size, free from cracks, twists or blemishes and uniform in colour. The adhesive shall be Tylon WB11 tile adhesive for ceramic tiles and Tylon adhesive for porcelain tiles if porcelain tiles is specified. The use of any other type shall only be allowed if approved by the Project manager after adhesive was tested on site. Joints shall be straight, continuous with 5mm widths and pointed with waterproofing grout compound from TAL, Tylon or aproved type. Symmetrical arrangement of tiling with cutting along both sides of panels to avoid cutting of tiles smaller than 75mm wide shall be done. Cutting and fitting of tiles against walls and around doorframes, sanitary fittings, etc must be neat, with a gap between 4 and 6mm. Tile shall be level to each other at joints. Replace one broken or cracked floor tile between existing tiles. Use notched trowel to apply adhesive 10mm X 10mm notches at 6mm intervals. The BLOB and SPOT method must not be used. All excess adhesive shall be removed from joints before drying has occurred. Tiles must be dry before being bedded. Tap tiles level with a rubber mallet. All tiles must make 100% contact with adhesive, make sure there are no voids. Any tile that sound hollow, if tapped, shall be removed. Allow the adhesive to cure for 2 to 3 days before grouting. Use only approved grout, mix grout with Tylon or Tal Bond-it in areas specified. Fill joints to lower edge of bevel and not level with the top of the tile. The work must be kept very clean during grouting as dried grout is almost impossible to remove from textured tiles. DO NOT USE ACIDS, SPIRITS OF SALTS, AMMONIA, OTHER STRONG CHEMICALS OR STEEL WOOL TO CLEAN TILES.
- 403 Work description: Shower floor break out tiles only
- 406 Work description: Lay ceramic floor tiles on shower floor.
Grout for shower floor tiles shall be mixed with Tylon or Tal bond it, not with water. Ceramic mosaic is to be of approved manufacturer and colour as specified. Tile size approximately 50 x 50 x 4 mm thick, fixed to paper in squares about 316 x 316 mm or 330 x 330 mm. Bed to 3:1 cement screed. Finish to a lightly scratched surface in mortar, composed of 1 part white cement to 3 parts of marble dust. After setting, remove paper and flush-up joints with waterproof grout.
TILE SHALL HAVE FALL TOWARDS OUTLET. TOP OF TILE SHALL BE LEVEL WITH TOP OF TRAP GRID. TILES SHALL BE IN STRAIGHT LINES. NO PONDING OF WATER SHALL BE ALLOWED.

PLUMBING INTERIOR

- 462 Work description: Remove wash hand basin, complete.

Respondent's signature: _____ Date: ____/____/____

ITEM NO. SPECIFICATIONS PER ITEM.

- 465 Work description: Install Vitreous china wash hand basin, 2 taps, connector, outlet and rubber trap.
Wash hand basins white porcelain/glazed ceramic and shall comply with (SABS 497). Pillar taps shall be chromium plated brass and of heavy pattern Cobra brand and shall comply with (SABS 226). Taps for hot water shall be marked with red coloured plastic inserts and fixed on the left hand side of all basins, sinks, showers, etc. Taps for cold water with green/blue plastic inserts on the right hand side. Waste outlet shall be chromium plated brass with plug, chain and of Cobra brand and shall comply with (SABS 226). Rubber trap shall comply with (SABS 1321). Installation of basin, taps, waste outlet and trap shall be done in accordance with the relevant manufacturer's instructions. Basin shall be fixed with silicone layer between basin and wall. Basin shall be level and shall be 800mm from finished floor level to top front section of basin if no pedestal basin is specified.
- 467 Work description: remove urinal stainless steel.
- 474 Work description: Install Wall mounted porcelain bowl urinal with flush master valve complete
Wall mounted urinals shall be of white glazed fireclay or vitreous china type, each approximately, with back flush entry and secured to wall with not less than two concealed hanger brackets. The urinals shall each be fitted with 38 mm diameter chromium plated domical grating, approved urinal flushing valve complete with push button assembly, spreader and all other necessary chromium plated fittings. Fit each urinal outlet with a white PVC, trap or brass chromium plated bottle trap.
- 489 Work description: Toilet pan and cistern remove complete
- 491 Work description: Fit Vaal Vitreous toilet complete include WC pan, cistern 11l, angle valve, flex connector and toilet seat
Pedestal water closet pans shall be of the wash down type, approximately 400 mm high, of white glazed fireclay or vitreous china, complying with the requirements of SABS Specification 497. The pans shall have "P" traps with straight outlets or right or left hand side outlets, as required. Pans shall be bedded onto the floors in 3:1 cement mortar. Pan shall be level and in parallel with wall next to Pan, Installation of the cistern shall be done in accordance with the relevant manufacturer's instructions. Use approved porcelain low level cistern that complying with the requirements of SABS Specification 821, and complying with the requirements of SABS Specification 497. Low level cisterns shall be of the valve less siphon type or of the flushing valve type, each with body and removable cover – NB: Flush pipes to flushing cisterns shall have an internal diameter of not less than 34 mm. Install Cobra brand angle valve with chrome plated or braided flex connector, any other brand make shall first be approved by project manager. The pan shall be fitted with approved solid plastic double flap seats having closed fronts of size and shape required to fit the pan each attached to pan with non-ferrous metal fixing bolts or plastic bolts.
- 497 Work description: Replace shower outlet, trap and waste pipe complete
Provide and set in the concrete filling 50mm diameter brass shower trap with brass chromium-plated grating. Grating shall be level with tile finish. From trap take 50mm diameter PVC waste pipe through wall to outside, fit inspection bend and continue down and along walls as required and connect to inlet on gulley head or direct to sewer.
- 499 Work description: Install under tile shower taps.
Taps shall be level and installed at right depth. Taps for hot water shall be marked with red coloured plastic inserts and fixed on the left hand side of all basins, sinks, showers, etc. Fit taps for cold water with green/blue plastic insets on the right hand side.

Respondent's signature: _____ Date: ____/____/____

ITEM NO. SPECIFICATIONS PER ITEM.

- 501 Work description: Fitb Cobra shower rose complete with arm.
Provide and fix in each shower cubicle an approved 50mm diameter brass chromium-plated shower rose connected with short length of 15mm diameter chromium-plated pipe taken down on wall to height required and connect to 15mm brass chromium-plated stop cock to cold water supply.
- 505 Work description: Supply and fit shower door, sliding.
Supply and install pivot shower door from Kal Aluminium or Wespeco or type approved by project manager. Install according to the manufacture's specifications.
- 537 Work description: Vertical or Horizontal chasing for pipes.
Made good in all trades, after pipes, etc. have been built in, all to the satisfaction of the representative/Agent.
- 538 Work description: Install / replace water pipes 15mm copper pipes
Copper pipes for domestic water services in all cases shall comply with the requirements of SABS Specification 460 Class 2 and 3. For applications below ground only Class 2 or 3 shall be used. Pipe work shall be of Class 2 or 3. Provision must be made for union couplings in strategic places. No exposed surface mounted piping will be permitted on wall surfaces except where it is avoidable and provided it is not unsightly, all to the approval of the Manager. A proper inclination shall be maintained in fixing pipes so that no air can be lodged in them. All pipe work to be installed in compliance with manufacturers specification and SABS 0252 code of practice. Provision must be made for thermal expansion and the proper anchoring there of. All pipe runs should be flushed, fastened and pressure tested, prior to the application of any terminal fittings.
- 539 Work description: Install / replace water pipes 22mm copper pipes.
Copper pipes for domestic water services in all cases shall comply with the requirements of SABS Specification 460 Class 2 and 3. For applications below ground only Class 2 or 3 shall be used. Pipe work shall be of Class 2 or 3. Provision must be made for union couplings in strategic places. No exposed surface mounted piping will be permitted on wall surfaces except where it is unavoidable and provided it is not unsightly, all to the approval of the Manager. A proper inclination shall be maintained in fixing pipes so that no air can be logged in them. All pipe work to be installed in compliance with manufacturers specification and SABS 0252 code of practice. Provision must be made for thermal expansion and the proper anchoring there of. All pipe runs should be flushed, fastened and pressure tested, prior to the application of any terminal fittings.
- 544 Work description: Supply a water point.
Provision must be made for union couplings in strategic places. Fittings shall be approved capillary solder type fittings or and brass compression fittings, each joint being formed by cutting the pipe-ends square with a pipe cutter. For capillary fittings use only 2 mm solid core wire solder and approved self cleaning paste. Joint shall be wiped clean with a damp cloth after jointing. All necessary couplings, connectors, bends, elbows, tees and other fittings as may be required, shall be provided to supply a water point.

FIT/REPLACE ITEMS/ FURNITURE

Respondent's signature: _____ Date: ____/____/____

ITEM NO. SPECIFICATIONS PER ITEM.

- 562 Work description: Fit/Replace mirror.
Mirrors shall comply with the requirements of SABS Specification 1236, Class A. Unframed mirrors shall have polished edges (Bevelled edges are not permitted). Provide mirrors where shown or mentioned, size as specified in work list, side shall be rounded and polished edge silvered plate glass. Each mirror to be drilled four (4) times and countersunk screwed to plugs in wall with 38 mm long screws, fitted with domed chromium-plated cups. Provide at each fixing point a felt washer between wall and mirror or if specified on work list with mirror adhesive.
- 565 Work description: Fit/Replace toilet paper holder/dispenser.
Replace/provide with type specified on work list. Chromium-plated toilet roll holders or White powder coated toilet paper dispenser holding 2 or 3 rolls.
- 566 Work description: Replace single 150mm x 150mm ceramic soap dish.
Remove existing cracked or damaged soap receptacles, including cement mortar. Thoroughly clean out and wet hole. Provide and fit in cement mortar, a new approved white or colour glazed earthenware soap receptacle with tongued lip. Soap receptacles are to be thoroughly wetted in water prior to fixing, and neatly finished off with neat white cement grout. work description:
- 569 Work description: Fit/Replace towel rail
Provide chrome plated towel rail and brackets. Towel rail shall be 1m long and fix with fisher plugs and at least 35mm long countersunk self-tapping screws. REFIX TOWEL RAILS: Remove loose towel rails from wall. Drill out the existing wall plugs and replace with new patent plastic or hardwood wall plugs. Refit towel rails with 38mm long chromium-plated round-headed screws, securely screwed to plugs in wall.
- 570 Work description: Fit/Replace hat and coat hooks.
Provide and fix in the position indicated or directed, 100 x 22mm thick oiled and polished hardwood rails with chamfered edges, screwed to plugs in walls and provide hat and coat hooks as sample No. 173, at approximately 200mm centres, securely screwed to hardwood rails. Replace missing hooks with new hat and coat hooks to match existing type.
- 572 Work description: Fit sign to indicate woman or men toilet
- 575 Work description: Replace wooden slats on shower benches.
Supply and fit five each 45mm x 45mm hardwood rounded slats 2000mm long. Fit slats to brackets with 6mm round head brass wood screws. Sand wood slats smooth and varnish two coats.
- ROOF
- 639 Work description: Paint expose roof timber purlin.
Item include cleaning by washing off all dirt. Remove all loose, chalky, flaking, peeling paint from wood, sand and wipe off sanding dust with damp cloth and leave to dry before applying paint.
- 640 Work description: Paint expose roof timber rafters.
Item include cleaning by washing off all dirt. Remove all loose, chalky, flaking, peeling paint from wood, sand and wipe off sanding dust with damp cloth and leave to dry before applying paint.

FACIA/BARGE BOARDS

Respondent's signature: _____ Date: ____/____/____

ITEM NO. SPECIFICATIONS PER ITEM.

- 657 Work description: Paint fascia board steel / Cement fibre two coats
STEEL FASCIA BOARDS: Clean from rust and dirt by scraping or by means of steel wire brush, sand completely and wipe off all sanding dust to obtain perfectly clean surface. Spot prime all exposed metal surface with an approved metal primer and apply two coats Plascon wall and all paint of Dulux wall guard paint
CEMENT FIBRE FASCIA BOARDS WITH PAINT IN GOOD CONDITION: Clean from all dust and dirt with approved detergent and rinse with clean water. Remove all defective paint, sand completely wipe off all sanding dust with a damp cloth, spot prime all nail and screw heads and apply two coats Plascon wall and all paint of Dulux wall guard paint or approved paint for cement fibre products.
NEW CEMENT FIBRE BARGE BOARDS NEW
Clean, spot prime nail and screw heads with universal undercoat and paint surfaces two coats Plascon wall and all or with two coats Dulux wall guard paint.

WINDOWS EXTERIOR

- 747 Work description: Paint window sills.
Remove all loose and defective paint, remove all polish with turps or thinners. Sand windowsills completely, wipe sill clean with damp cloth to remove all sanding dust. Apply two coats Plascon or Dulux floor/stoep paint.

"PREVIEW COPY ONLY"

Respondent's signature: _____ Date: ____/____/____

ANNEXURE B

TENDER PRICE LIST PER ITEM

ASSET DESCRIPTION: Mess room

CITY / TOWN: Saldanha

TENDER NO: SAZ/52492

ASSET NO: 02BA086C

WORK DESCRIPTION Maintenance to messroom

TENDER PRICE LIST TO INTERIOR AND EXTERIOR WORK TO BUILDINGS

Measurements and or quantities do not include off cuts or waste all measurements of material is measure as nett fixed. Contractor to add his own % for off cuts and waste.

The contractor is responsible to check all the measurements and quantities before ordering any material. The measurement and quantities are only a guide for tender purposes.

Value Added Tax (VAT) shall be excluded in the schedule of rates and prices.

To be supplied by the Contractor: The Contractor shall provide all labour, material, transport, consumable stores, plant, equipment, tools, services, materials and ingredients of every description required for the carrying out and completion of the WORK as per the attached work list and specification and as may be ordered by the Project Manager.

GENERAL: The Building will be occupied during renovations, The Project manager, contractor and manager of the TFR staff using the building will discuss and agree on site the maintenance plan for the building. The necessary move of furniture in the same room if necessary is included in all the items. All normal cleaning, preparations include sanding, stopping and washing of items to be painted as specified by the paint manufacturer is included in all the paint items. Where abnormal cleaning is required it will be specified as an additional item. All scaffolding and use of ladders up to 4.50m high interior and exterior if and as necessary is part of all the items. All work shall be done according to the attached specifications and shall comply with the National building regulations. Unless otherwise specified all materials must comply with SANS specifications.

Where no applicable SANS Specification exists the materials must be approved by the Transnet Freight Rail project manager.

All material shall be fitted, install or applied as specified by the manufacture.

The contractor shall be liable for any damages caused by his or her staff to any Transnet Freight Rail property or equipment.

SAFETY: The contractor shall comply with the Occupational Health Safety Act, 1993 (Act 85 of 1993).

Page 1 of 5

SUB TOTAL PAGE 1

TENDER NO: SAZ/52492

ASSET NO: 02BA086C

ITEM NO	FAULT DISCRPTION	ITEM TOTAL	MEASURE UNIT	UNIT RATE	ITEM AMOUNT
CEILINGS					
5	Break out gypsum/nutec ceiling boards. leave brandering for re-use, remove all clout nails and remove all rubble from site. line up brandering where necessary, ready to fit new ceiling boards. (new ceiling boards not included in item)	36	M^2		
8	Install PVC ceiling as per specifications.	36	M^2		
WALLS INTERIOR					

Respondent's signature: _____ Date: ____/____/____

--

TENDER NO: SAZ/52492

ASSET NO: 02BA086C

ITEM NO	FAULT DISCRPTION	ITEM TOTAL	MEASURE UNIT	UNIT RATE	ITEM AMOUNT
68	New rhino lite plaster finish. apply plaster primer then apply 3 addition coats silk water base Dulux wash 'n wear or Plascon double velvet paint as per attached item specifications and paint specifications.	76	M^2		
73	Knotty pine type wood wall finish, prepare and paint 2 coats as per attached specifications	76	M^2		
123	Install rhino dry-wall, install system number 1. use rhino 12.5mm thick (specify height) long boards both sides, height 2.70m. item do not include doorframes or paint, item is only to erect wall as per attached specification	76	M		
DOORS/SECURITY GATES					
287	Paint door complete both sides, side edges, top edge undercoat and 2 coats Dulux pearlglo river rock code 6j1-7. Do preparation before painting per spec. Door 810mmx2.03m=3.66m ² . 75mmx2.03m=3.42m ² . Item include remove before paint and refit of handles	10	EA		
288	Varnish double door complete both sides, side edges and top edge, 3 coats varnish. use exterior varnish on exterior side. door 1.70m X 2.10m. Item include remove and re-fit of handle	3	EA		
303	Security gate prepare for painting, spot prime, paint 1 coat universal undercoat and 1 coat white gloss enamel. single standard 810 x 2030mm gate, 40mm square tubing outer frame. 25mm square tubing gate frame and 12mm dia round bars . see attached spec	1	EA		
DOORFRAMES					
329	Paint door frame 1 coat undercoat and 2 coats Dulux pearlglo lockness code-3l1-5. single steel frame. 115mm=1.150m ² . single 230mm=1.750m ² . double 1511mm x 115mm=1.29 m ² . double 1511mm x 230mm=1.96 m ² . Do preparation as per specification	10	EA		
332	Varnish door frame with fan light, complete 2 coats. varnish, item includes varnish of fan light window. use exterior varnish on frames in exterior walls. after preparation as per attached specification.	3	EA		
FLOORS					
365	Chip 80 % of concrete floor area. supply and apply Tylon or tal key coat to floor for ceramic tiles (please read the manufacture specifications on container on how to mix and apply the key coat)	18	M^2		
366	Lay 1st grade ceramic floor tiles on floor (use 10 x 6mm notched trowel) joints 5mm wide use only Tylon WB11 tile adhesive for ceramic tiles adhesive as approved by project manager. Type tile as per sample tile shown at site meeting Read specifications	138	M^2		
403	Shower floor, break tiles out and remove adhesive and clean floor to receive new tiles	18	M^2		
406	Tile shower floor with 50mm x 50mm dark grey mosaic tiles. tile shall have fall towards outlet. top of tiles shall be level with the top of outlet trap grid. fit 2 rows of mosaic tiles as skirting. mix grout with Tylon Tal bond it, not water	18	M^2		
PLUMBING INTERIOR					
462	Remove hand wash basin complete with brackets and waste pipe. item include the repair of all holes in wall. item does not include the water pipes. see item to remove water pipes per job as necessary.	6	EA		

Respondent's signature: _____ Date: ____/____/____

--

TENDER NO: SAZ/52492

ASSET NO: 02BA086C

ITEM NO	FAULT DISCRPTION	ITEM TOTAL	MEASURE UNIT	UNIT RATE	ITEM AMOUNT
465	Install Vaal Vitreous china porcelain wash hand basin, 2 cobra heavy pattern pillar taps with star handle, 2 braided flex connectors, chrome plated brass outlet, chain, plug and rubber trap (install basin 800mm high from floor to front top edge of basin)	6	JOB		
467	remove stainless steel urinal and make good wall for tiles	1	EA		
474	Install/replace large type porcelain bowl urinal with grate outlet plastic white bottle trap complete (install urinal 650mm from floor level to front top edge of urinal)	3	EA		
489	Remove toilet pan and cistern complete, item do not include pipes	5	EA		
491	Fit Vaal Vitreous toilet complete include wc pan, cistern 11l, angle valve, flex connector and heavy duty plastic seat	5	EA		
497	Install shower outlet. fit brass p trap/plastic with chrome plated outlet and PVC waste pipe complete to outside of building include all necessary fittings	8	EA		
499	Install heavy pattern Cobra under tile shower tap with star handle (item does not include pipe work and water point. see item for pipes and to provide water point)	16	EA		
501	Fit Prestex balljoint shower rose fitted to an 026 shower arm with swivel type complete with cobra brass chrome plated extension pipe with cover plate	8	EA		
505	Install Kal/Wespeco or approved sliding glass and aluminium shower door with obscure/frosted glass. silicone sealer shall be applied between tiles and aluminium frame before fitting frame and not after frame has been fixed.	8	EA		
537	Vertical or horizontal chasing for pipe up to 50mm wide x 50mm deep. make good after pipe installation has been completed. repair to match wall finish.	60	M		
538	Install water pipes 15mm class 2 copper pipes against wall and or in wall and or in roof, item exclude fittings, item to supply water point cover the fittings. (pipes in wall, all the pipe work shall be inspected before closing of pipes with plaster)	20	M		
539	Install water pipes 22mm class 2 copper pipes against wall and or in wall and or in roof. item excludes fittings, item to supply water point cover the fittings. (pipes in wall, all the pipe work shall be inspected before closing of pipes with plaster).	40	M		
544	Fit a water point class 2 copper pipe. item include as necessary 15mm and or 22mm capillary or compression fittings. this is to supply all materials and labour to bring the necessary water to the basin, shower, cistern or sink, but excludes the pipe work	2	EA		
FIT/REPLACE ITEMS/ FURNITURE					
562	Fit mirror 350mm x 450mm fix with two sided tape and mirror adhesive	6	EA		
565	Fit toilet paper holder white lockable paper dispenser type holding 2 or 3 rolls	5	EA		
566	Break out broken porcelain soap dish, supply new porcelain soap dish and install complete in position with ceramic tile adhesive and finish joints with grout to match tiles. (for shower fit 1250mm height from shower floor)	8	EA		
569	Fit / replace towel rail	3	EA		

Respondent's signature: _____ Date: ____/____/____

--

TENDER NO: SAZ/52492

ASSET NO: 02BA086C

ITEM NO	FAULT DISCRPTION	ITEM TOTAL	MEASURE UNIT	UNIT RATE	ITEM AMOUNT
570	Fit or replace hat and coat hooks, use only heavy duty chrome plated type that is approved by project manager	12	EA		
572	Fit standard type plastic 200mm x 200m sign to door to indicate men and or woman toilet or ablution facilities.	2	EA		
575	Replace wooden slats on shower benches	10	EA		
ROOF					
639	Paint exposed roof timber purlin, paint 1 pink wood primer, 1 coat universal undercoat and 2 coats white Dulux roof guard paint. apply paint only after preparation as per attached specification	44	M		
640	Paint exposed roof timber rafters, (36 ea)800mm X 270mm 1 coat universal undercoat and 2 coats Dulux high gloss or similar product paint Paint sprockets 300mm x 225mm same as above.(16 ca)	52	EA		
FACIA/BARGE BOARDS					
657	Paint facia board steel / nutec fibre cement, 2 coats Plascon wall and all paint or with Dulux white roof guard paint (paint only front side) apply paint only after preparation as per attached specification has been done	69	M ²		
WINDOWS EXTERIOR					
747	Paint previously painted window sills, any type. apply 2 coats stoep or floor paint. apply paint only after preparation as per attached specification has been done	15	EA		

"PREVIEW COPY ONLY"

Respondent's signature: _____ Date: ____/____/____

TENDER NO: SAZ/52492

ASSET NO: 02BA086C

ITEM NO	FAULT DISCRIPTION	ITEM TOTAL	MEASURE UNIT	UNIT RATE	ITEM AMOUNT
---------	-------------------	------------	--------------	-----------	-------------

TOTAL PAGE 1 TO PAGE 5 R

PRELIMINARY AND GENERAL

P and G shall include all cost not directly relate to a specific item on the schedule of prices and rates. All items not specifically mentioned in the Schedule of Rates and prices and form part of contractor's requirements such as cost of stationery, as well as establishment of workers on site and removal of site establishment, it will also include the handing over of the site to the contractor and the handing back of the site after completion of work .

P + G

R

RISK AND SAFETY

Cost for the risk and saftey must include the risk assessment. The risk assesment is a full identification of the risks before the work starts and the necessary equipment, appropriate precautions and systems of work that must be provided and Implemented.

RISK AND SAFETY R

Cost for risk and safety include complete compliance with the current Occupational Health . Safety Act.

Included in risk and safety. The standardised Transnet Freight Rail induction shall be given to all staff of all contractors at the start of each project and the contractors shall send all his staff that will work on the Transnet Freight Rail site to the induction on the date as agreed on between TFR Project manager and the contractor.

TOTAL PRICE CIVIL WORK EXLUDE VAT R

"PREVIEW COPY ONLY"

The total price must be carried forward to Section 2 (page 13) (exc VAT) .

Respondent's signature: _____ Date: ____/____/____

ANNEXURE A

ASSET DESCRIPTION: Mess room

ASSET LOCATION: Infra depot

CITY / TOWN: Saldanha

WORK DESCRIPTION: Maintenance to mess & ablution

TENDER NO: SAZ/52492

ASSET NO: 02BA085S

ITEM NO. SPECIFICATIONS PER ITEM.

CEILINGS

- 5 Work description: Break out ceiling boards, only leave brandering.
Break out ceiling boards, inspect brandering and contact project manager if any section of brandering needs replacing. Remove all clout nails or any other nails that were used to fix boards and where necessary fix loose brandering. Line up brandering in straight line.
- 8 Work description: Fit PVC ceiling complete, exclude brandering.
The ceiling board must always be fixed with the length of the board at right angles to the brandering. Boards shall be secured at 150mm centres with 25mm galvanised chipboard screws. The ceiling shall be neatly finished with PVC cornice.

DOORS/SECURITY GATES

- 245 Work description: Replace indicator locking bolt
Replace indicator locking bolt, type as specify on work list. Screws for fixing of barrel bolts shall be of matching metal and finish
- 288 Work description: Varnish double doors complete, 2 coats.
Previously varnished doors: Remove handles, wash thoroughly with a suitable detergent to remove all dirt and rinse with clean water. Remove defective varnish and repair all holes and defective places with a suitable wood filler. Sand complete door and wipe off all sanding dust with a damp cloth. Allow to dry and apply two coats of varnish on varnished doors. Re-fit door handles
New doors to be varnished: Remove lock and door handles, Fill all defective places with suitable wood filler, sand smooth and wipe sanding dust off with damp cloth. Allow to dry and apply. Apply three coats varnish on doors. Allow varnish to dry between coats. Re-fit lock and handles.

DOORFRAMES

- 329 Work description: Paint frame complete 2 coats.
Previously painted wooden door frame: Wash thoroughly with a suitable detergent to remove all dirt, rinse with clean water. Remove defective paint/varnish and repair all holes and defective places with a suitable wood filler. Sand complete frame and wipe off all sanding dust with a damp cloth. Allow too dry and apply one coat universal and two coat finishing paint as per work list. Previously painted steel doorframes: Clean door frame from all rust and dirt by means of scraping, steel wire brush or sanding. Sand frame complete and wipe off all sanding dust with damp cloth. Allow too dry. Spot prime all exposed metal surfaces with an approved metal primer. Apply one coat universal undercoat and two coats finishing paint as per work list. New wooden door frames to be painted/varnished: Sand smooth, wipe sanding dust off with damp cloth, allow to dry and apply one coat wood primer, one coat universal undercoat and two finishing coats as per work list. As allow paint to dry between coats.

Respondent's signature: _____ **Date:** ____/____/____

ITEM NO. SPECIFICATIONS PER ITEM.

- 332 Work description: Varnish single doorframe with fan light, complete 2 coats.
Previously varnished wooden door frames: Wash thoroughly with a suitable detergent to remove all dirt, rinse with clean water. Remove defective varnish and repair all holes and defective places with a suitable wood filler. Sand complete frame and wipe off all sanding dust with a camp cloth. Allow too dry and apply two coats of varnish. New wooden door frames to be varnished: Sand smooth, use damp cloth to wipe off sanding dust, allow to dry, apply three coats varnish to door frame. As per specification, allow varnish to dry between coats.

FLOORS

- 345 Work description: Remove vinyl floor tiles and clean floor
Remove tiles completely and remove all debris from site.
- 363 Work description: Remove ceramic tile from floor
- 365 Work description: Chip 80% and provide key coat on floor for ceramic tiles.
Chip floor to 80%. Before tiling, clean floor, apply Tylon (Tylon key it mixed with Tylon plaskey) or Tal primer and keying agent for use on smooth surfaces. Mix and apply primer and keying agent as per the manufacture specifications on container on how to mix and apply the key coat)
- 366 Work description: Lay first grade ceramic tiles on floor.
*BEFORE TILING COMMENCES, THE REPRESENTATIVE MUST FIRST APPROVE THE SURFACE, IN SITE BOOK.*ALL TILES THAT SOUND HOLLOW SHALL BE REMOVED AND RE-FIXED. ***USE ONLY TYLON WB11, TAL PROFESSIONAL ADHESIVE OR TYPE APPROVED BY PROJECT MANAGER. ***NEVER USE SPOT OR BLOB METHODS.***NEVER BUT JOINT TILES. Thoroughly clean surfaces before any tiling commences. Smooth or painted surfaces must be chipped to 80% of area. KEY IT from TAL or TYLON must be applied over whole area. Glazed floor tiles shall comply with (SABS 1449). Tiles shall be even in shape and size, free from cracks, twists or blemishes and uniform in colour. The adhesive shall be Tylon WB11 tile adhesive for ceramic tiles and Tylon adhesive for porcelain tiles if porcelain tiles is specified. The use of any other type shall only be allowed if approved by the Project manager after adhesive was tested on site. Joints shall be straight, continuous with 5mm widths and pointed with waterproofing grout compound from TAL, Tylon or approved type. Symmetrical arrangement of tiling with cutting along both sides of panels to avoid cutting of tiles smaller than 75mm wide shall be done. Cutting and fitting of tiles against walls and around doorframes, sanitary fittings, etc must be neat, with a gap between 4 and 6mm. Tile shall be level to each other at joints. Replace one broken or cracked floor tile between existing tiles. Use notched trowel to apply adhesive 10mm X 10mm notches at 6mm intervals. The BLOB and SPOT method must not be used. All excess adhesive shall be removed from joints before drying has occurred. Tiles must be dry before being bedded. Tap tiles level with a rubber mallet. All tiles must make 100% contact with adhesive, make sure there are no voids. Any tile that sound hollow, if tapped, shall be removed. Allow the adhesive to cure for 2 to 3 days before grouting. Use only approved grout, mix grout with Tylon or Tal Bond-it in areas specified. Fill joints to lower edge of bevel and not level with the top of the tile. The work must be kept very clean during grouting as dried grout is almost impossible to remove from textured tiles. DO NOT USE ACIDS, SPIRITS OF SALTS, AMMONIA, OTHER STRONG CHEMICALS OR STEEL WOOL TO CLEAN TILES.
- 403 Work description: Shower floor break out tiles only

Respondent's signature: _____ Date: ____/____/____

ITEM NO. SPECIFICATIONS PER ITEM.

- 406 Work description: Lay ceramic floor tiles on shower floor.
Grout for shower floor tiles shall be mixed with Tylon or Tal bond it, not with water. Ceramic mosaic is to be of approved manufacturer and colour as specified. Tile size approximately 50 x 50 x 4 mm thick, fixed to paper in squares about 316 x 316 mm or 330 x 330 mm. Bed to 3:1 cement screed. Finish to a lightly scratched surface in mortar, composed of 1 part white cement to 3 parts of marble dust. After setting, remove paper and flush-up joints with waterproof grout.
TILE SHALL HAVE FALL TOWARDS OUTLET. TOP OF TILE SHALL BE LEVEL WITH TOP OF TRAP GRID. TILES SHALL BE IN STRAIGHT LINES. NO PONDING OF WATER SHALL BE ALLOWED.

PLUMBING INTERIOR

- 462 Work description: Remove wash hand basin, complete.
- 465 Work description: Install Vaal Vitreous wash hand basin, 2 taps, connector, outlet and rubber trap.
Wash hand basins white porcelain/glazed ceramic and shall comply with (SABS 497). Pillar taps shall be chromium plated brass and of heavy pattern Cobra brand and shall comply with (SABS 226). Taps for hot water shall be marked with red coloured plastic inserts and fixed on the left hand side of all basins, sinks, showers, etc. Taps for cold water with green/blue plastic inserts on the right hand side. Waste outlet shall be chromium plated brass with plug, chain and of Cobra brand and shall comply with (SABS 226). Rubber trap shall comply with (SABS 1321). Installation of basin, taps, waste outlet and trap shall be done in accordance with the relevant manufacturer's instructions. Basin shall be fixed with silicone layer between basin and wall. Basin shall be level and shall be 800mm from finished floor level to top front section of basin if no pedestal basin is specified.
- 489 Work description: Toilet pan and cistern remove complete
- 491 Work description: Fit Vaal porcelain toilet complete include WC pan, cistern 11l, angle valve, flex connector and toilet seat
Pedestal water closet pans shall be of the wash down type, approximately 400 mm high, of white glazed fireclay or vitreous china, complying with the requirements of SABS Specification 497. The pans shall have "P" traps with straight outlets or right or left hand side outlets, as required. Pans shall be bedded onto the floors in 3:1 cement mortar. Pan shall be level and in parallel with wall next to Pan, Installation of the cistern shall be done in accordance with the relevant manufacturer's instructions. Use approved porcelain low level cistern that complying with the requirements of SABS Specification 821, and complying with the requirements of SABS Specification 497. Low level cisterns shall be of the valve less siphon type or of the flushing valve type, each with body and removable cover – NB: Flush pipes to flushing cisterns shall have an internal diameter of not less than 34 mm. Install Cobra brand angle valve with chrome plated or braided flex connector, any other brand make shall first be approved by project manager. The pan shall be fitted with approved solid plastic double flap seats having closed fronts of size and shape required to fit the pan each attached to pan with non-ferrous metal fixing bolts or plastic bolts.
- 497 Work description: Replace shower outlet, trap and waste pipe complete
Provide and set in the concrete filling 50mm diameter brass shower trap with brass chromium-plated grating. Grating shall be level with tile finish. From trap take 50mm diameter PVC waste pipe through wall to outside; fit inspection bend and continue down and along walls as required and connect to inlet on gulley head or direct to sewer.

Respondent's signature: _____ Date: ____/____/____

ITEM NO. SPECIFICATIONS PER ITEM.

- 499 Work description: Install under tile shower taps.
Taps shall be level and installed at right depth. Taps for hot water shall be marked with red coloured plastic inserts and fixed on the left hand side of all basins, sinks, showers, etc. Fit taps for cold water with green/blue plastic inserts on the right hand side.
- 501 Work description: Fit shower rose
Provide and fix in each shower cubicle an approved 50mm diameter Prestex balljoint brass chromium-plated shower rose connected with short length of 15mm diameter chromium-plated pipe taken down on wall to height required and connect to 15mm brass chromium-plated stop cock to cold water supply.
- 505 Work description: Supply and fit shower door, sliding.
Supply and install pivot shower door from Kal Aluminium or Wespeco or type approved by project manager. Install according to the manufacture's specifications.
- 538 Work description: Install / replace water pipes 15mm copper pipes
Copper pipes for domestic water services in all cases shall comply with the requirements of SABS Specification 460 Class 2 and 3. For applications below ground only Class 2 or 3 shall be used. Pipe work shall be of Class 2 or 3. Provision must be made for union couplings in strategic places. No exposed surface mounted piping will be permitted on wall surfaces except where it is avoidable and provided it is not unsightly, all to the approval of the Manager. A proper inclination shall be maintained in fixing pipes so that no air can be lodged in them. All pipe work to be installed in compliance with manufacturers specification and SABS 0252 code of practice. Provision must be made for thermal expansion and the proper anchoring there of. All pipe runs should be flushed, fastened and pressure tested, prior to the application of any terminal fittings.
- 539 Work description: Install / replace water pipes 22mm copper pipes.
Copper pipes for domestic water services in all cases shall comply with the requirements of SABS Specification 460 Class 2 and 3. For applications below ground only Class 2 or 3 shall be used. Pipe work shall be of Class 2 or 3. Provision must be made for union couplings in strategic places. No exposed surface mounted piping will be permitted on wall surfaces except where it is unavoidable and provided it is not unsightly, all to the approval of the Manager. A proper inclination shall be maintained in fixing pipes so that no air can be lodged in them. All pipe work to be installed in compliance with manufacturers specification and SABS 0252 code of practice. Provision must be made for thermal expansion and the proper anchoring there of. All pipe runs should be flushed, fastened and pressure tested, prior to the application of any terminal fittings.
- 544 Work description: Supply a water point.
Provision must be made for union couplings in strategic places. Fittings shall be approved capillary solder type fittings or and brass compression fittings, each joint being formed by cutting the pipe-ends square with a pipe cutter. For capillary fittings use only 2 mm solid core wire solder and approved self cleaning paste. Joint shall be wiped clean with a damp cloth after jointing. All necessary couplings, connectors, bends, elbows, tees and other fittings as may be required, shall be provided to supply a water point.

FIT/REPLACE ITEMS/ FURNITURE

Respondent's signature: _____ Date: ____/____/____

ITEM NO. SPECIFICATIONS PER ITEM.

- 562 Work description: Fit/Replace mirror.
Mirrors shall comply with the requirements of SABS Specification 1236, Class A. Unframed mirrors shall have polished edges (Bevelled edges are not permitted). Provide mirrors where shown or mentioned, size as specified in work list, side shall be rounded and polished edge silvered plate glass. Each mirror to be drilled four (4) times and countersunk screwed to plugs in wall with 38 mm long screws, fitted with domed chromium-plated cups. Provide at each fixing point a felt washer between wall and mirror or if specified on work list with mirror adhesive.
- 565 Work description: Fit/Replace toilet paper holder/dispenser.
Replace/provide with type specified on work list. Chromium-plated toilet roll holders or White powder coated toilet paper dispenser holding 2 or 3 rolls.
- 566 Work description: Replace single 150mm x 150mm ceramic soap dish.
Remove existing cracked or damaged soap receptacles, including cement mortar. Thoroughly clean out and wet hole. Provide and fit in cement mortar, a new approved white or colour glazed earthenware soap receptacle with tongued lip. Soap receptacles are to be thoroughly wetted in water prior to fixing, and neatly finished off with neat white cement grout. work description:
- 569 Work description: Fit/Replace towel rail
Provide chrome plated towel rail and brackets. Towel rail shall be 1m long and fix with fisher plugs and at least 35mm long countersunk self-tapping screws. REFIX TOWEL RAILS: Remove loose towel rails from wall. Drill out the existing wall plugs and replace with new patent plastic or hardwood wall plugs. Refit towel rails with 38mm long chromium-plated round-headed screws, securely screwed to plugs in wall.
- 570 Work description: Fit/Replace hat and coat hooks.
Provide and fix in the position indicated or directed, 100 x 22mm thick oiled and polished hardwood rails with chamfered edges, screwed to plugs in walls and provide hat and coat hooks as sample No. 173, at approximately 200mm centres, securely screwed to hardwood rails. Replace missing hooks with new hat and coat hooks to match existing type.
- 572 Work description: Fit sign to indicate woman or men toilet
- 575 Work description: Replace wooden slats on shower benches.
Supply and fit five each 45mm x 45mm hardwood rounded slats 2000mm long. Fit slats to brackets with 6mm round head brass wood screws. Sand wood slats smooth and varnish two coats.
- ROOF**
- 639 Work description: Paint expose roof timber purlin.
Item include cleaning by washing off all dirt. Remove all loose, chalky, flaking, peeling paint from wood, sand and wipe off sanding dust with damp cloth and leave to dry before applying paint.
- 640 Work description: Paint expose roof timber rafters.
Item include cleaning by washing off all dirt. Remove all loose, chalky, flaking, peeling paint from wood, sand and wipe off sanding dust with damp cloth and leave to dry before applying paint.

FACIA/BARGE BOARDS

Respondent's signature: _____ Date: ____/____/____

ITEM NO. SPECIFICATIONS PER ITEM.

- 657 Work description: Paint fascia board steel / Cement fibre two coats
STEEL FASCIA BOARDS: Clean from rust and dirt by scraping or by means of steel wire brush, sand completely and wipe off all sanding dust to obtain perfectly clean surface. Spot prime all exposed metal surface with an approved metal primer and apply two coats Plascon wall and all paint of Dulux wall guard paint
CEMENT FIBRE FASCIA BOARDS WITH PAINT IN GOOD CONDITION: Clean from all dust and dirt with approved detergent and rinse with clean water. Remove all defective paint, sand completely wipe off all sanding dust with a damp cloth, spot prime all nail and screw heads and apply two coats Plascon wall and all paint of Dulux wall guard paint or approved paint for cement fibre products.
NEW CEMENT FIBRE BARGE BOARDS NEW
Clean, spot prime nail and screw heads with universal undercoat and paint surfaces two coats Plascon wall and all or with two coats Dulux wall guard paint.

WINDOWS EXTERIOR

- 747 Work description: Paint window sills.
Remove all loose and defective paint, remove all polish with turps or thinners. Sand windowsills completely, wipe sill clean with damp cloth to remove all sanding dust. Apply two coats Plascon or Dulux floor/stoep paint.

"PREVIEW COPY ONLY"

Respondent's signature: _____ Date: ____/____/____

ANNEXURE B

TENDER PRICE LIST PER ITEM

ASSET DESCRIPTION: Mess room

CITY / TOWN: Saldanha

TENDER NO: SAZ/52492

ASSET NO: 02BA085S

WORK DESCRIPTION Maintenance to mess & ablution

TENDER PRICE LIST TO INTERIOR AND EXTERIOR WORK TO BUILDINGS

Measurements and or quantities do not include off cuts or waste all measurements of material is measure as nett fixed. Contractor to add his own % for off cuts and waste.

The contractor is responsible to check all the measurements and quantities before ordering any material. The measurement and quantities are only a guide for tender purposes.

Value Added Tax (VAT) shall be excluded in the schedule of rates and prices.

To be supplied by the Contractor: The Contractor shall provide all labour, material, transport, consumable stores, plant, equipment, tools, services, materials and ingredients of every description required for the carrying out and completion of the WORK as per the attached work list and specification and as may be ordered by the Project Manager.

GENERAL: The Building will be occupied during renovations, The Project manager, contractor and manager of the TFR staff using the building will discuss and agree on site the maintenance plan for the building. The necessary move of furniture in the same room if necessary is included in all the items. All normal cleaning, preparations include sanding, stopping and washing of items to be painted as specified by the paint manufacturer is included in all the paint items. Where abnormal cleaning is required it will be specified as an additional item. All scaffolding and use of ladders up to 4.50m high interior and exterior if and as necessary is part of all the items. All work shall be done according to the attached specifications and shall comply with the National building regulations. Unless otherwise specified all materials must comply with SANS specifications.

Where no applicable SANS Specification exists the materials must be approved by the Transnet Freight Rail project manager.

All material shall be fitted, install or applied as specified by the manufacture.

The contractor shall be liable for any damages caused by his or her staff to any Transnet Freight Rail property or equipment.

SAFETY: The contractor shall comply with the Occupational Health Safety Act, 1993 (Act 85 of 1993).

Page 1 of 4

SUB TOTAL PAGE 1

--

TENDER NO: SAZ/52492

ASSET NO: 02BA085S

ITEM NO	FAULT DISCRIPTION	ITEM TOTAL	MEASURE UNIT	UNIT RATE	ITEM AMOUNT
CEILINGS					
5	Break out gypsum/nutec ceiling boards. leave brandering for re-use, remove all clout nails and remove all rubble from site. line up brandering where necessary, ready to fit new ceiling boards. (new ceiling boards not included in item)	31	M^2		
8	Install PVC ceiling as per specifications.	31	M^2		
DOORS/SECURITY GATES					

Respondent's signature: _____ Date: ____/____/____

--

TENDER NO: SAZI/52492

ASSET NO: 02BA085S

ITEM NO	FAULT DISCIPTION	ITEM TOTAL	MEASURE UNIT	UNIT RATE	ITEM AMOUNT
245	Replace/ Fit rabone indicator locking bolt on door complete. (specify type)	4	EA		
288	Varnish double door complete both sides, side edges and top edge, 3 coats varnish. use exterior varnish on exterior side. door 1.70m X 2.10m. Item include remove and re-fit of handle	7	EA		
DOORFRAMES					
329	Paint door frame 1 coat undercoat and 2 coats Dulux peariglo lockness code-311-5. single steel frame. 115mm=1.150m2. single 230mm=1.750m2. double 1511mm x 115mm=1.29 m2. double 1511mm x 230mm=1.96 m2. Do preparation as per specification	10	EA		
332	Varnish door frame with fan light, complete 2 coats. varnish, item includes varnish of fan light window. use exterior varnish on frames in exterior walls. after preparation as per attached specification.	3	EA		
FLOORS					
345	Remove vinyl floor tiles complete and clean floor from all adhesive	78	M^2		
363	Remove ceramic tiles from sub floor with all adhesive	18	M^2		
365	Chip 80 % of concrete floor area. supply and apply Tylon or tal key coat to floor for ceramic tiles (please read the manufacture specifications on container on how to mix and apply the key coat)	88	M^2		
366	Lay 1st grade ceramic floor tiles on floor (use 10 x 6mm notched trowel) joints 5mm wide use only Tylon WB11 tile adhesive for ceramic tiles adhesive as approved by project manager. Type tile as per sample tile shown at site meeting Read specifications	138	M^2		
403	Shower floor, break tiles out and remove adhesive and clean floor to receive new tiles	18	M^2		
406	Tile shower floor with 50mm x 50mm dark grey mosaic tiles. tile shall have fall towards outlet. top of tiles shall be level with the top of outlet trap grid. fit 2 rows of mosaic tiles as skirting. mix grout with Tylon Tal bond it, not water	8	M^2		
PLUMBING INTERIOR					
462	Remove hand wash basin complete with brackets and waste pipe. item include the repair of all holes in wall. item does not include the water pipes. see item to remove water pipes per job as necessary.	4	EA		
465	Install Vaal Vitreous china wash hand basin, 2 cobra heavy pattern pillar taps with star handle, 2 braided flex connectors, chrome plated brass outlet, chain, plug and rubber trap (install basin 800mm high from floor to front top edge of basin)	4	JOB		
489	Remove toilet pan and cistern complete, item do not include pipes	4	EA		
491	Fit Vaal Vitreous china WC. toilet complete include wc pan, cistern 11l, angle valve, flex connector and heavy duty plastic seat	4	EA		
497	Install shower outlet. fit brass p trap/plastic with chrome plated outlet and PVC waste pipe complete to outside of building include all necessary fittings	4	EA		
499	Install heavy pattern Cobra under tile shower tap with star handle (item does not include pipe work and water point. see item for pipes and to provide water point)	8	EA		
501	Fit / replace shower rose with swivel type complete with cobra brass chrome plated extension pipe with cover plate	4	EA		

Respondent's signature: _____ Date: ____/____/____

--

TENDER NO: SAZ/52492

ASSET NO: 02BA085S

ITEM NO	FAULT DISCIPTION	ITEM TOTAL	MEASURE UNIT	UNIT RATE	ITEM AMOUNT
505	Install Kal/Wespeco or approved sliding glass and aluminium shower door with obscure/frosted glass. silicone sealer shall be applied between tiles and aluminium frame before fitting frame and not after frame has been fixed.	4	EA		
538	Install water pipes 15mm class 2 copper pipes against wall and or in wall and or in roof, item exclude fittings, item to supply water point cover the fittings. (pipes in wall, all the pipe work shall be inspected before closing of pipes with plaster).	20	M		
539	Install water pipes 22mm class 2 copper pipes against wall and or in wall and or in roof. item excludes fittings, item to supply water point cover the fittings. (pipes in wall, all the pipe work shall be inspected before closing of pipes with plaster).	30	M		
544	Fit a water point class 2 copper pipe. item include as necessary 15mm and or 22mm capillary or compression fittings. this is to supply all materials and labour to bring the necessary water to the basin, shower, cistern or sink, but excludes the pipe work	2	EA		
FIT/REPLACE ITEMS/ FURNITURE					
562	Fit mirror 350mm x 450mm fix with two sided tape and mirror adhesive	4	EA		
565	Fit toilet paper holder white lockable paper dispenser type holding 2 or 3 rolls	5	EA		
566	Break out broken porcelain soap dish, supply new porcelain soap dish and install complete in position with ceramic tile adhesive and finish joints with grout to match tiles. (for shower fit 1250mm height from shower floor)	4	EA		
569	Fit towel rail	4	EA		
570	Fit or replace hat and coat hooks, use only heavy duty chrome plated type that is approved by project manager	12	EA		
572	Fit standard type plastic 200mm x 200mm sign to door to indicate men and or woman toilet or ablution facilities.	2	EA		
575	Replace wooden slats on shower benches	10	EA		
ROOF					
639	Paint exposed roof timber purlin, paint 1 pink wood primer, 1 coat universal undercoat and 2 coats white Dulux roof guard paint. apply paint only after preparation as per attached specification	44	M		
640	Paint exposed roof timber rafters, (36 ea)800mm X 270mm 1 coat universal undercoat and 2 coats Dulux high gloss or similar product paint Paint sprockets 300mm x 225mm same as above.(16 ea)	52	EA		
FACIA/BARGE BOARDS					
657	Paint facia board steel / nutec fibre cement, 2 coats Plascon wall and all paint or with Dulux white roof guard paint (paint only front side) apply paint only after preparation as per attached specification has been done	69	M^2		
WINDOWS EXTERIOR					
747	Paint previously painted window sills, any type. apply 2 coats stoep or floor paint. apply paint only after preparation as per attached specification has been done	15	EA		

Respondent's signature: _____ Date: ____/____/____

TENDER NO: SAZ/52492

ASSET NO: 02BA085S

ITEM NO	FAULT DISCRPTION	ITEM TOTAL	MEASURE UNIT	UNIT RATE	ITEM AMOUNT
---------	------------------	------------	--------------	-----------	-------------

TOTAL PAGE 1 TO PAGE 4 R

PRELIMINARY AND GENERAL

P and G shall include all cost not directly relate to a specific item on the schedule of prices and rates. All items not specifically mentioned in the Schedule of Rates and prices and form part of contractor's requirements such as cost of stationery, as well as establishment of workers on site and removal of site establishment, it will also include the handing over of the site to the contractor and the handing back of the site after completion of work .

P + G

R

RISK AND SAFETY

Cost for the risk and safety must include the risk assessment. The risk assesment is a full identification of the risks before the work starts and the necessary equipment, appropriate precautions and systems of work that must be provided and implemented.

RISK AND SAFETY R

Cost for risk and safety include complete compliance with the current Occupational Health Safety Act.

Included in risk and safety. The standardised Transnet Freight Rail induction shall be given to all staff of all contractors at the start of each project and the contractors shall send all his staff that will work on the Transnet Freight Rail site to the induction on the date as agreed on between TFR Project manager and the contractor.

TOTAL PRICE CIVIL WORK EXLUDE VAT R

The total price must be carried forward to Section 2 (page 13) (exc VAT) .

Respondent's signature: _____ Date: ____/____/____



SPECIAL CONDITIONS

SAZ52492 : MAINTENANCE TO THE MESS AND ABLUTION AT SALKOR SALDANHA

1. TIME TO COMPLETE THE WORK

The contract period for this project will not exceed **4 months**. This period shall be exclusive of weekends, public holidays and statutory holiday periods.

Failing completion of the work within the period as stipulated above or with any shorter period offered by the contenders and accepted by Transnet, the contractor shall pay to Transnet the sum of **R800-00** for every day or part thereof during which the works remain incomplete.

2. GUARANTEE

Transnet Freight Rail requires a workmanship guarantee for a period of **12 months**, from the date of completion of work.

3. INSPECTION OF WORKS

- 3.1 During the progress of the contract, all materials used and all work being undertaken by the Contractor shall be subjected to periodic inspections.
- 3.2 Should at any stage in the progress of the said works, an inspection visit or test reveal any defects due to improper materials or workmanship or any other fault or neglect on the part of the Contractor, such defective materials or workmanship shall immediately be replaced or remedied by the Contractor at his own expense and to the entire satisfaction of the authorized representative.
- 3.3 No work shall be covered up or put out of view without the approval of the Project Manager. The Contractor shall afford full opportunity for the Project Manager to examine and measure any work, which is about to be covered up or put out of view before permanent work is place thereon.
- 3.4 The Contractor shall give due notice to the Project Manager whenever such work is ready or about to be ready for examination. The Project Manager shall without unreasonable delay, examine and or measure such work as required.
- 3.5 The Contractor shall uncover any part or parts of the work or make openings in or through the same as the Project Manager may from time to time direct and shall reinstate and make good such part or parts to

Respondent's Signature

1

Date and Company Stamp



the satisfaction of the Project Manager. If any such part of parts have been covered up or put out of view after compliance with the requirements and are found to be executed in accordance with the Contract, the expenses of uncovering, making openings in or through for the reinstating and making good shall be borne by the Contractor.

4. SITE RECORDS

4.1 Site Instruction Book

The Contractor shall provide a **site instruction book, in triplicate for the Project Manager to place all instructions** that are needed to compliment the specifications and drawings and any other instruction that may affect the cost of the work.

No work will be recognized for additional payment unless it has been recorded and signed by the Project Manager in the aforesaid book.

4.2 Site Diary

The Contractor shall provide a diary, in triplicate to record all day-to-day incidents that could occur during the contract period. This includes weather, name & numbers of workers on the site, material that has been delivered, material that has been loaded and disposed of, incidences that have occurred, nature of work to be done on that day, etc.

4.3 Programme & Planning of the work

The contractor shall provide to the Project Manager a detailed plan of how he intends to do the work and this plan must be to the requirements of the operation of Transnet Freight Rail workshop with minor disruptions as no delays must be allowed in this regard.

The programme must be agreed to (in the site instruction book) before any work will be allowed to commence. The programme can be in a form of a pert (bar) chart and will be used as a guide to measure progress of the work.

4.4 Handing over of site

No work will commence before the site has been officially handed over by the Project Manager by means of a written site hand over document and instruction in the Site Instruction Book.



5. WATER SUPPLY

Water may be made available for the purpose of construction of the works only. The water shall be used conservatively and if not, this privilege shall be removed and the water shall be metered, and the cost of the metered water shall be borne by the Contractor as well as all charges as entertained by Transnet Freight Rail. The Contractor must supply all connections, hoses and applicable equipment where necessary.

6. ELECTRICITY SUPPLY

Electricity may be made available to the Contractor. The contractor must adhere to the safety standards as per the General Safety Regulations, Electrical Machine Regulations, Electrical Installation Regulations of the **Health and Safety Act**, (Act 85 of 1993) and SANS 10142. The Contractor must supply all leads and plugs as necessary.

7. ACCESS TO SITE

The areas are restricted and the contractor must ensure he complies with the regulations of Transnet Freight Rail in every way. The Contractor and/or any sub-contractors shall be required to apply for permission to enter the restricted area in writing. A list of workmen shall be given to the Project Manager to arrange for the necessary permits, 48 hours minimum notice is necessary for processing these permits. This includes changes to staff during the contract period. The contractor shall also provide each of his workers with a laminated identification card. On the front of the card must be the contract business name and a photo of the employee. On the back of the card the following local emergency numbers shall be printed Ambulance service, Fire department and Police. The employee shall not be allowed on site if he does not have his identification card with him.

8. MATERIALS FOUND ON SITE

The Contractor shall not use on the works any materials found on the site without the prior written consent of the Project Manager. No material that is lying on the site (other than that as specified in this document) or on Transnet Freight Rail's Property may be removed (even if deemed as scrap) by the contractor.

9. CLEARING OF SITE

The Contractor shall provide for cleaning up and sorting all rubbish and debris of whatever kind, generated by this work only, throughout the duration of the contract. Upon completion the Contractor shall clear away and remove all rubbish, unused material, plant and debris and leave the site and the whole of the works clean and tidy to the satisfaction of the Project Manager.

Respondent's Signature

3

Date and Company Stamp



10. WORKING OUTSIDE NORMAL WORKING HOURS

Normal working hours are between 07:30 and 16:00 Mondays to Fridays. If it is required to work outside the stated normal working hours the Contractor must obtain written permission at least 24 hours before such work needs to be undertaken. Transnet Freight Rail will not unreasonably withhold permission; however the Contractor may have to pay for Transnet Freight Rail's supervisory personnel.

11. ESCALATION

This contract does not make provision for compensation in respect of increased costs. The contenders must allow in his fixed price for any increased costs, which he may encounter during the contract period or such extended period as agreed upon by both parties.

12. RETENTION

To protect Transnet Freight Rail in case of any defective work, Transnet Freight Rail reserves the right to retain up to ten (10) percent of the value of the contract, for a period of six (6) months, (the maintenance period) or such further period beyond the maintenance period if defects have not yet been made good to the satisfaction of the Project Manager.

13. SAFETY PRECAUTIONS

13.1 Safety

The Contractor shall submit a Health and Safety Plan to cover this Project before any site will be handed over for approval. This will also cover the standard risk and Safety Plan for this project.

The Contractor will however also be responsible to do a Risk Assessment and if there is any risk that is not covered under the general Risk Assessment that is included in the Health and Safety plan the Risk Assessment will be included in the Health and Safety Plan.

The Contractor must have first aid box on site. The first aid box shall be stocked with the equipment as per general safety regulation and the location of the first aid box will be indicated with appropriate signage.

The Contractor and all his employees shall attend a Safety Induction session on safety before commencement of the project. The contractor and his employees shall certify the register that they attended the Safety Induction session and only workers who have attended the session will be allowed to work on the site.

Respondent's Signature

Date and Company Stamp



13.2 Act 85

The contractor shall comply with the Occupational Health & Safety Act, 1993 (Act 85 of 1993).

13.3 Environment

The Contractor shall, at all times, comply with the statutes that prohibit pollution of any kind. These statutes are enacted in the following legislation.

- ◆ The National Environmental Management Act, 107/1998;
- ◆ The Environmental Conservation Act, 73/1989; and
- ◆ The National Water Act, 36/1998.

The Contractor shall appoint a responsible person to ensure that no incident shall occur on site that could cause pollution. Where the Contractor was negligent and caused any form of pollution the damage shall be rectified at the Contractor's cost.

14. STORAGE AND SAFE KEEPING

The Contractor will provide his own portable store facilities, the store appearance shall be subject to the approval of the Project Manager. The agreed location of the store will be indicated to the contractor by the Project Manager.

The contractor is responsible for the safe keeping of all his material and equipment on site.

15. REGULATIONS

In so far as they can be applied and where they are not inconsistent with the terms of the Project Specifications, the following **SANS Regulations** shall be regarded as being embodied in the Project Specification. These regulations must to be obtained by the contenders.

- | | |
|---------------------------------|----------------------|
| ◆ National Building Regulations | SANS 10400 – 11990 |
| ◆ General Structural | SANS 11200AH – 11982 |
| ◆ Electrical Code of Practice | SANS 10142 |
| ◆ The Construction Regulations | GN 1010 (Act 85) |

16. TO BE SUPPLIED BY THE CONTRACTOR

The Contractor shall provide all labour, transport, consumable stores, plant, equipment, tools, services, materials and ingredients of every description required for the carrying out and completion of the WORKS as per this specification and as may be ordered by the Manager.

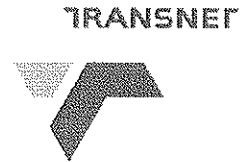

17. SITE MEETINGS

The Contractor shall be called upon to attend meetings on the site to discuss the progress of WORKS with the Transnet Freight Rail representatives.

18. SETTING OUT OF THE WORKS

The setting out of the work shall be the sole responsibility of the Contractor and shall be done in accordance with this Specification, the drawings and the design.

19. KEEP SITE TIDY

The Contractor shall keep the site tidy at all times and remove all old material and such as rubble, off-cuts, demolished material, surplus material and carry away and dump or store onto or at an approved site.

20. SUB-CONTRACTOR

The Contractor shall not assign his obligations under the contract, nor sublet the contract work. Where specialized work or part thereof is required the contractor can use a subcontractor with the consent of the Transnet Freight Rail Project Manager.

21. ADDITIONAL WORK

No work will be recognized for additional payment unless it has been arranged with the Project Manager.

22. MEASURE OF WORK

Contractor to check all measurements provided on work and price list before submitting quote per project. The list provided by Transnet is only a guide, contractor to inform project manager of any discrepancies in measurements and quantities before submitting quote for Project. Contractor is also responsible to do all measuring work for material needed.

23. SUPERVISION

The Transnet Property Technical Manager will delegate a responsible person (Project manager) to take control of the supervision and management of the contract. The contractor shall only respond to these incumbents that have been appointed in writing, any instruction that is not given via the delegated managers will be null and void.

Respondent's Signature

Date and Company Stamp



24. HIRE EQUIPMENT

If necessary to hire abnormal equipment to do any work, the payment for the hire equipment shall be market related priced. The approval of the Transnet Project manager is required before such equipment is hired.

25. OCCUPYING OF BUILDINGS

When the buildings are occupied during renovations by Transnet Freight Rail staff, the Project Manager, Contractor and the Manager of the Transnet staff using the building will discuss and agree, on site, the maintenance plan for the building and on how to accommodate the staff during the project.

26. PRODUCTS & TRADE NAMES

26.1 Where trade names and catalogue references have been used in these Specifications to specify a product, Tenderers must tender on that particular or similar product. In addition, Tenderers must tender on the design specified. The accepted tenderer (i.e. Contractor) may, after obtaining written authority from the Project Manager, use an alternative product or design.

26.2 Where such written authority is given by the Project Manager at the request of the Contractor, for the contractor's convenience, all additional costs involved will be done for the Contractor's account. In the event of a less expensive product or design being used, a variation order reflecting the saving in cost will be issued.

27. PRELIMINARY AND GENERAL (P & G)

The P & G shall be as per General & Special Conditions and will include all costs not directly related to the execution of the work as stated. All items not specifically mentioned in the Annexure B must form part of P & G's

28. SUBSTANCE ABUSE TESTING

The OHS Act (Act 85 of 1993) clearly states in the Safety Regulations 2A **"INTOXICATION" An employer or user, as the case may be, shall not permit any person who appears to be under the influence of intoxicating liquor or drugs, to enter or remain at a workplace.** Transnet Freight Rail enforces this legislation by means of its Substance Abuse Policy, and therefore reserves the right to do substance abuse testing on anyone who enters their premises.

SconSAZ52492

Respondent's Signature

Date and Company Stamp

TRANSNET LIMITED

(Registration no. 1990/000900/30)

**SAFETY ARRANGEMENTS AND PROCEDURAL COMPLIANCE
WITH THE OCCUPATIONAL HEALTH AND SAFETY ACT
(ACT 85 OF 1993) AND APPLICABLE REGULATIONS****1. General**

- 1.1 The Contractor and Transnet Limited (hereinafter referred to as "Transnet") are individual employers, each in its own right, with their respective duties and obligations set out in the Occupational Health and Safety Act, Act 85 of 1993 (the Act) and applicable Regulations.
- 1.2 The Contractor accepts, in terms of the General Conditions of Contract and in terms of the Act, his obligations as an employer in respect of all persons in his employ, other persons on the premises or the Site or place of work or on the work to be executed by him, and under his control. He shall, before commencement with the execution of the contract work, comply with the provisions set out in the Act, and shall implement and maintain a Health and Safety Plan as described in the Construction Regulations, 2003 and as approved by Transnet, on the Site and place of work for the duration of the Contract.
- 1.3 The Contractor accepts his obligation to complying fully with the Act and applicable Regulations notwithstanding the omission of some of the provisions of the Act and the Regulations from this document.
- 1.4 Transnet accepts, in terms of the Act, its obligations as an employer of its own employees working on or associated with the site or place of work, and the Contractor and Technical Officer or his deputy shall at all times, co-operate in respect of the health and safety management of the site, and shall agree on the practical arrangements and procedures to be implemented and maintained during execution of the Works.
- 1.5 In the event of any discrepancies between any legislation and this specification, the applicable legislation will take precedence.

2. Definitions

- 2.1 In this Specification any word or expression to which a meaning has been assigned in the Construction Regulations, shall have the meaning so assigned to it, unless the context otherwise indicates: -
- 2.2 The work included in this Contract shall for the purposes of compliance with the Act be deemed to be "**Construction Work**", which, in terms of the Construction Regulations, 2003 means any work in connection with: -
 - (a) the erection, maintenance, alteration, renovation, repair, demolition or dismantling of or addition to a building or any similar structure;

- (b) the installation, erection, dismantling or maintenance of fixed plant where such work includes the risk of a person falling;
 - (c) the construction, maintenance, demolition or dismantling of any bridge, dam, canal, road, railway, runway, sewer or water reticulation system or any similar civil engineering structure; or
 - (d) the moving of earth, clearing of land, the making of an excavation, piling, or any similar type of work;
- 2.3 **“competent person”** in relation to construction work, means any person having the knowledge, training and experience specific to the work or task being performed: Provided that where appropriate qualifications and training are registered as per the South African Qualifications Authority Act, 1995 these qualifications and training shall be deemed to be the required qualifications and training;
- 2.4 **“contractor”** means principal contractor and **“subcontractor”** means contractor as defined by the Construction Regulations, 2003.
- 2.5 **“fall protection plan”** means a documented plan, of all risks relating to working from an elevated position, considering the nature of work undertaken, and setting out the procedures and methods applied to eliminate the risk;
- 2.6 **“health and safety file”** means a file, or other record in permanent form, containing the information required to be kept on site in accordance with the Act and applicable Regulations;
- 2.7 **“Health and Safety Plan ”** means a documented plan which addresses the hazards identified and include safe work procedures to mitigate, reduce or control the hazards identified;
- 2.8 **“Risk Assessment”** means a programme to determine any risk associated with any hazard at a construction site, in order to identify the steps needed to be taken to remove, reduce or control such hazard;
- 2.9 **“the Act”** means the Occupational Health and Safety Act No. 85 of 1993.

3. Procedural Compliance

3.1 The Contractor who intends to carry out any construction work shall, before carrying out such work, notify the Provincial Director in writing if the construction work:-

- (a) includes the demolition of a structure exceeding a height of 3 metres; or
- (b) includes the use of explosives to perform construction work; or
- (c) includes the dismantling of fixed plant at a height greater than 3m,

and shall also notify the Provincial Director in writing when the construction work exceeds 30 days or will involve more than 300 person days of construction work and if the construction work:-

- (a) includes excavation work deeper than 1m; or

- (b) includes working at a height greater than 3 metres above ground or a landing.
- 3.2 The notification to the Provincial Director shall be on a form similar to Annexure A of the Construction Regulations, 2003, also shown in Annexure 1 of this Specification. The Contractor shall ensure that a copy of the completed notification form is kept on site for inspection by an inspector, Technical Officer or employee.
- 3.3 The Contractor shall, in accordance with the Act and applicable Regulations, make all the necessary appointments of competent persons in writing on a form similar to Annexure 2 of this Specification and deliver copies thereof to the Technical Officer. Copies should also be retained on the health and safety file.
- 3.4 Subcontractors shall also make the above written appointments and the Contractor shall deliver copies thereof to the Technical Officer.
- 3.5 In the case of a self-employed Contractor or any subcontractor who has the appropriate competencies and supervises the work himself, the appointment of a construction supervisor in terms of regulation 6.1 of the Construction Regulations, 2003 will not be necessary. The Contractor shall in such a case execute and sign a declaration, as in Annexure 3, by which he personally undertakes the duties and obligations of the "Chief Executive Officer" in terms of section 16(1) of the Act.
- 3.6 The Contractor shall, before commencing any work, obtain from the Technical Officer an access certificate as in Annexure 4 executed and signed by him, permitting and limiting access to the designated site or place of work by the Contractor and any subcontractors under his control.
- 3.7 Procedural compliance with Act and Regulations, as above, shall also apply to any subcontractors as employers in their own right. The Contractor shall furnish the Technical Officer with full particulars of such subcontractors and shall ensure that they comply with the Act and Regulations and Protekon's safety requirements and procedures.

4. **Special Permits**

Where special permits are required before work may be carried out such as for hotwork, isolation permits, work permits and occupations, the Contractor shall apply to the Technical Officer or the relevant authority for such permits to be issued. The Contractor shall strictly comply with the conditions and requirements pertaining to the issue of such permits.

5. **Health and Safety Programme**

- 5.1 The Tenderer shall, with his tender, submit a Health and Safety Programme setting out the practical arrangements and procedures to be implemented by him to ensure compliance by him with the Act and Regulations and particularly in respect of: -
- (i) The provision, as far as is reasonably practical, of a working environment that is safe and without risk to the health of his employees and subcontractors in terms of section 8 of the Act;

- (ii) the execution of the contract work in such a manner as to ensure in terms of section 9 of the Act that persons other than those in the Contractor's employment, who may be directly affected by the contract work are not thereby exposed to hazards to their health and safety;
 - (iii) ensuring, as far as is reasonably practical, in terms of section 37 of the Act that no employee or subcontractor of the Contractor does or omits to do any act which would be an offence for the Contractor to do or omit to do.
- 5.2 The Contractor's Health and Safety Programme shall be based on a risk assessment in respect of the hazards to health and safety of his employees and other persons under his control that are associated with or directly affected by the Contractor's activities in performing the contract work and shall establish precautionary measures as are reasonable and practical in protecting the safety and health of such employees and persons.
- 5.3 The Contractor shall cause a risk assessment contemplated in clause 5.2 above to be performed by a competent person, appointed in writing, before commencement of any Construction Work and reviewed during construction. The Risk Assessments shall form part of the Health and Safety programme to be applied on the site and shall include at least the following:
- (a) The identification of the risks and hazards that persons may be exposed to;
 - (b) the analysis and evaluation of the hazards identified;
 - (c) a documented Health and Safety Plan, including safe work procedures to mitigate, reduce or control the risks identified;
 - (d) a monitoring and review plan.
- 5.4 The Health and Safety Plan shall include full particulars in respect of: -
- (a) The safety management structure to be instituted on site or place of work and the names of the Contractor's health and safety representatives and members of safety committees where applicable;
 - (b) the safe working methods and procedures to be implemented to ensure the work is performed in compliance with the Act and Regulations;
 - (c) the safety equipment, devices and clothing to be made available by the Contractor to his employees;
 - (d) the site access control measures pertaining to health and safety to be implemented;
 - (e) the arrangements in respect of communication of health and safety related matters and incidents between the Contractor, his employees, subcontractors and the Technical Officer with particular reference to the reporting of incidents in compliance with Section 24 and General Administrative Regulation 8 of the Act and with the pertinent clause of the General Conditions of Contract forming part of the Contract and

- (f) the introduction of control measures for ensuring that the Safety Plan is maintained and monitored for the duration of the Contract.
- 5.4 The Health and Safety programme shall be subject to the Technical Officer's approval and he may, in consultation with the Contractor, order that additional and/or supplementary practical arrangements and procedures be implemented and maintained by the Contractor or that different working methods or safety equipment be used or safety clothes be issued which, in the Technical Officer's opinion, are necessary to ensure full compliance by the Contractor with his obligations as an employer in terms of the Act and Regulations. The Technical Officer or his deputy shall be allowed to attend meetings of the Contractor's safety committee as an observer.
- 5.5 The Contractor shall take reasonable steps to ensure that each subcontractor's Health and Safety Plan is implemented and maintained on the construction site: Provided that the steps taken, shall include periodic audits at intervals mutually agreed to between the them, but at least once every month.
- 5.6 The Contractor shall stop any subcontractor from executing any construction work, which is not in accordance with the Contractor's, and/or subcontractor's Health and Safety Plan for the site or which poses a threat to the health and safety of persons.
- 5.7 The Contractor shall ensure that a copy of the Health and Safety Plan is available on site for inspection by an inspector, Technical Officer, agent, subcontractor, employee, registered employee organisation, health and safety representative or any member of the health and safety committee.
- 5.8 The Contractor shall consult with the health and safety committee or, if no health and safety committee exists, with a representative group of employees, on the development, monitoring and review of the Risk Assessment.
- 5.9 The Contractor shall ensure that all employees under his control are informed, instructed and trained by a competent person regarding any hazard and the related work procedures before any work commences, and thereafter at such times as may be determined in the Risk Assessment.
- 5.10 The Contractor shall ensure that all subcontractors are informed regarding any hazard as stipulated in the Risk Assessment before any work commences, and thereafter at such times as may be determined in the Risk Assessment.
- 5.11 The Contractor shall ensure that all visitors to a construction site undergoes health and safety induction pertaining to the hazards prevalent on the site and shall be provided with the necessary personal protective equipment.

6. Fall Protection Plan

- 6.1 In the event of the risk and hazard identification, as required in terms of clause 5.3 of this Specification, revealing risks relating to working from an elevated position the contractor shall cause the designation of a competent person, responsible for the preparation of a fall protection plan;

- 6.2 The Contractor shall implement, maintain and monitor the fall protection plan for the duration of Contract. The Contractor shall also take such steps to ensure the continued adherence to the fall protection plan.
- 6.3 The fall protection plan shall include:-
- (a) A Risk Assessment of all work carried out from an elevated position;
 - (b) the procedures and methods to address all the identified risks per location;
 - (c) the evaluation of the employees physical and psychological fitness necessary to work at elevated positions;
 - (d) the training of employees working from elevated positions; and
 - (e) the procedure addressing the inspection, testing and maintenance of all fall protection equipment.

7. Hazards and Potential Hazardous Situations

The Contractor and the Technical Officer shall immediately notify one another of any hazardous or potentially hazardous situations which may arise during performance of the Contract by the Contractor or any subcontractor and, in particular, of such hazards as may be caused by the design, execution and/or location and any other aspect pertaining to the contract work.

8. Health and Safety File

- 8.1 The Contractor shall ensure that a health and safety file is opened and kept on site and shall include all documentation required as per the Act and applicable regulations, and made available to an inspector, the Technical Officer, or subcontractor upon request.
- 8.2 The Contractor shall ensure that a copy of the both his Health and Safety Plan as well as any subcontractor's Health and Safety Plan is available on request to an employee, inspector, contractor or the Technical Officer.
- 8.3 The Contractor shall hand over a consolidated health and safety file to the Technical Officer upon completion of the Construction Work and shall in addition to documentation mentioned in the Act and applicable Regulations include a record of all drawings, designs, materials used and other similar information concerning the completed structure.

ANNEXURE 1**OCCUPATIONAL HEALTH AND SAFETY ACT, 1993****Regulation 3(1) of the Construction Regulations****NOTIFICATION OF CONSTRUCTION WORK**

-
-
- 1(a) Name and postal address of principal contractor:

- (b) Name and tel. no of principal contractor's contact person:

2. Principal contractor's compensation registration number: _____
- 3.(a) Name and postal address of client:

- (b) Name and tel no of client's contact person or agent:

- 4.(a) Name and postal address of designer(s) for the project:

- (b) Name and tel. no of designer(s) contact person:

5. Name and telephone number of principal contractor's construction supervisor on site appointed in terms of regulation 6(1).

6. Name/s of principal contractor's construction sub-ordinate supervisors on site appointed in terms of regulation 6(2).

7. Exact physical address of the construction site or site office:

8. Nature of the construction work:

9. Expected commencement date: _____
10. Expected completion date: _____

11. Estimated maximum number of persons on the construction site: _____

12. Planned number of contractors on the construction site accountable to the principle contractor:

13. Name(s) of contractors already chosen.

Principal Contractor

Date

Client

Date

* THIS DOCUMENT IS TO BE FORWARDED TO THE OFFICE OF THE DEPARTMENT OF LABOUR **PRIOR TO COMMENCEMENT** OF WORK ON SITE.

* **ALL PRINCIPAL CONTRACTORS** THAT QUALIFY TO NOTIFY MUST DO SO EVEN IF ANOTHER PRINCIPAL CONTRACTOR ON THE SAME SITE HAD DONE SO PRIOR TO THE COMMENCEMENT OF WORK.

"PREVENTIVE COPY ONLY"

ANNEXURE 2

(COMPANY LETTER HEAD)

OCCUPATIONAL HEALTH AND SAFETY ACT, 1993 (ACT 85 OF 1993) :

SECTION/REGULATION: _____

REQUIRED COMPETENCY: _____

In terms of _____ I, _____

representing the Employer) do hereby appoint _____

As the Competent Person on the premises at _____

(physical address) to assist in compliance with the Act and the applicable Regulations.

Your designated area/s is/are as follows :-

Date : _____

Signature :- _____

Designation :- _____

ACCEPTANCE OF DESIGNATION

I, _____ do hereby accept this Designation and acknowledge that I understand the requirements of this appointment.

Date : _____

Signature :- _____

Designation :- _____

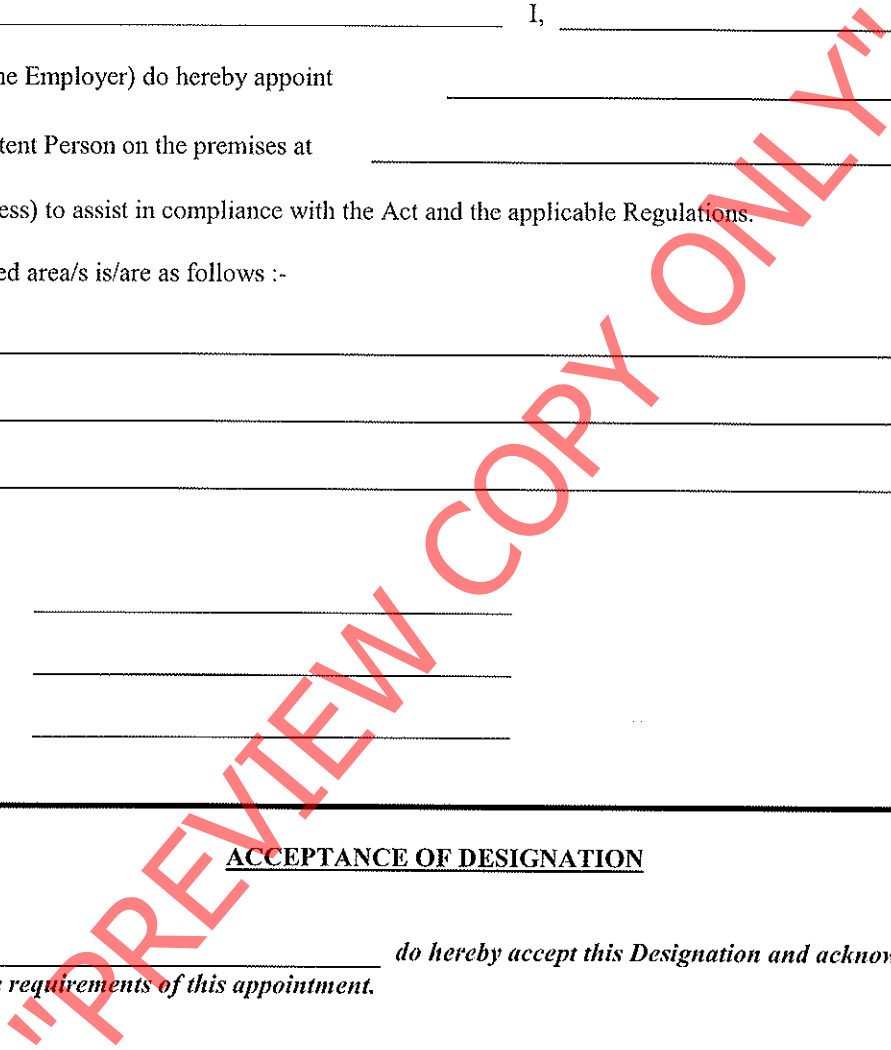

ANNEXURE 3**(COMPANY LETTER HEAD)****OCCUPATIONAL HEALTH AND SAFETY ACT, 1993 (ACT 85 OF 1993) :****DECLARATION**

In terms of the above Act I, _____ am personally assuming the duties and obligations as Chief Executive Officer, defined in Section 1 of the Act and in terms of Section 16(1), I will, as far as is reasonably practicable, ensure that the duties and obligations of the Employer as contemplated in the above Act are properly discharged.

Signature :- _____

Date : _____

"PREVIEW COPY ONLY"

ANNEXURE 4

(LETTER HEAD OF BUSINESS DIVISION OR UNIT OF TRANSNET LIMITED)

SITE ACCESS CERTIFICATE

Access to : _____ (Area)
Name of Contractor/Builder :- _____
Contract/Order No.: _____

The contract works site/area described above are made available to you for the carrying out of associated works

In terms of your contract/order with
(company) _____

Kindly note that you are at all times responsible for the control and safety of the Works Site, and for persons under your control having access to the site.

As from the date hereof you will be responsible for compliance with the requirements of the Occupational Health and Safety Act, 1993 (Act 85 of 1993) as amended, and all conditions of the Contract pertaining to the site of the works as defined and demarcated in the contract documents including the plans of the site or work areas forming part thereof.

Signed : _____ Date : _____
TECHNICAL OFFICER

ACKNOWLEDGEMENT OF RECEIPT

Name of Contractor/Builder :- _____ I,
_____ do hereby acknowledge and accept the duties
and obligations in respect of the Safety of the site/area of Work in terms of the Occupational Health and
Safety Act; Act 85 of 1993.

Name : _____ Designation : _____

Signature : _____ Date : _____

TRANSNET

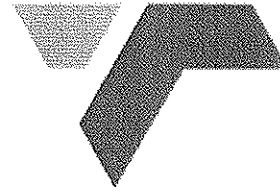

Transnet SOC Limited Registration Number 1990/00900/06

TRANSNET SPECIFICATION

**E7/1 - SPECIFICATION FOR GENERAL WORK AND
WORKS ON, OVER, UNDER OR ADJACENT TO RAILWAY
LINES AND NEAR HIGH VOLTAGE EQUIPMENT**

(This specification shall be used in network operator contracts)









"PREVIEW COPY ONLY"

Circulation Not Restricted

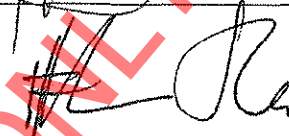
© This document as a whole is protected by copyright. The information herein is the sole property of Transnet SOC Ltd. It may not be used, disclosed or reproduced in part or in whole in any manner whatsoever, except with the written permission of and in a manner permitted by the proprietors.

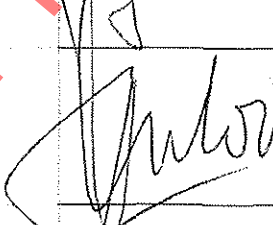
(This page not to be issued with contract)

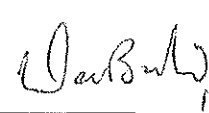
SPECIFICATION FOR GENERAL WORK AND WORKS ON, OVER, UNDER OR ADJACENT TO RAILWAY LINES AND NEAR HIGH VOLTAGE EQUIPMENT

Author:	Project Manager Capital Program (Electrical)	G. Maposa	
Approved:	Senior Engineer Infra Engineering (Train Authorisation Systems)	J. van den Berg	
"	Principal Engineer Infra Engineering (Track)	M. Marutla	
"	Principal Engineer Infra Engineering (Structures)	J. Homan	
"	Principal Engineer Infra Engineering (Electrical)	J. Vosloo	
"	Principal Engineer Technology Management (Electrical)	W. Coetzee	
"	Chief Engineer Transport Telecoms	D. Botha	 17 June 11
Authorised:	Chief Engineer Infrastructure Engineering	J. van Aardt	 2011/06/30

Date: May 2011

(This page not to be issued with contract)

TRANSNET

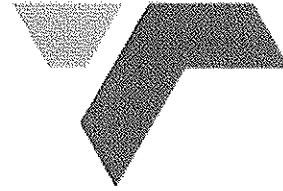

Transnet SOC Limited Registration Number 1990/00900/06

TRANSNET SPECIFICATION

**E7/1 - SPECIFICATION FOR GENERAL WORK AND
WORKS ON, OVER, UNDER OR ADJACENT TO RAILWAY
LINES AND NEAR HIGH VOLTAGE EQUIPMENT**

(This specification shall be used in network operator contracts)

"PREVIEW COPY ONLY"

Circulation Not Restricted

© This document as a whole is protected by copyright. The information herein is the sole property of Transnet SOC Ltd. It may not be used, disclosed or reproduced in part or in whole in any manner whatsoever, except with the written permission of and in a manner permitted by the proprietors.

CONTENTS		
<u>CLAUSE</u>	<u>HEADING</u>	<u>PAGE</u>
1.0	SCOPE	3
2.0	DEFINITIONS	3
PART A - GENERAL SPECIFICATION		
3.0	AUTHORITY OF OFFICERS OF TRANSNET	4
4.0	CONTRACTOR'S REPRESENTATIVES AND STAFF	4
5.0	OCCUPATIONS AND WORK PERMITS	4
6.0	SPEED RESTRICTIONS AND PROTECTION	5
7.0	ROADS ON THE NETWORK OPERATOR'S PROPERTY	5
8.0	CLEARANCES	5
9.0	STACKING OF MATERIAL	5
10.0	EXCAVATION, SHORING, DEWATERING AND DRAINAGE	5
11.0	FALSEWORK FOR STRUCTURES	6
12.0	PILING	6
13.0	UNDERGROUND SERVICES	6
14.0	BLASTING AND USE OF EXPLOSIVES	6
15.0	RAIL TROLLEYS	7
16.0	SIGNAL TRACK CIRCUITS	7
17.0	PENALTY FOR DELAYS TO TRAINS	7
18.0	SURVEY BEACONS AND PEGS	7
19.0	TEMPORARY LEVEL CROSSINGS	8
20.0	COMPLETION OF THE WORKS	8
21.0	PROTECTION OF PERSONS AND PROPERTY	9
22.0	INTERFERENCE WITH THE NETWORK OPERATOR'S ASSETS AND WORK ON OPEN LINES	10
23.0	ACCESS, RIGHTS-OF-WAY AND CAMPSITES	10
24.0	SUPERVISION	10
25.0	HOUSING OF EMPLOYEES	10
26.0	OPTICAL FIBRE CABLE ROUTES	10
PART B - ADDITIONAL SPECIFICATION FOR WORK NEAR HIGH-VOLTAGE ELECTRICAL EQUIPMENT		
27.0	GENERAL	11
28.0	WORK ON BUILDINGS OR FIXED STRUCTURES	11
29.0	WORK DONE ON OR OUTSIDE OF ROLLING STOCK, INCLUDING LOADING AND UNLOADING	11
30.0	USE OF EQUIPMENT	12
31.0	CARRYING AND HANDLING MATERIAL AND EQUIPMENT	12
32.0	PRECAUTIONS TO BE TAKEN WHEN ERECTING OR REMOVING POLES, ANTENNAE AND TREES ETC.	12
33.0	USE OF WATER	13
34.0	USE OF CONSTRUCTION PLANT	13
35.0	WORK PERFORMED UNDER DEAD CONDITIONS UNDER COVER OF A WORK PERMIT	13
36.0	TRACTION RETURN CIRCUITS IN RAILS	13
37.0	HIGH-VOLTAGE ELECTRICAL EQUIPMENT NOT MAINTAINED AND/OR OPERATED BY THE NETWORK OPERATOR	14

1.0 SCOPE

- 1.1 This specification covers the network operator's requirements for general work and works on, over, under or adjacent to railway lines and near high voltage equipment.

2.0 DEFINITIONS

The following definitions shall apply:

"Authorised Person" - A person whether an employee of the network operator or not, who has been specially authorised to undertake specific duties in terms of Transnet' publication Electrical Safety Instructions, and who holds a certificate or letter of authority to that effect.

"Barrier" Any device designed to restrict access to "live" high-voltage electrical equipment.

"Bond" - A short conductor installed to provide electrical continuity.

"Contractor" - Any person or organisation appointed by the network operator to carry out work on its behalf.

"Contract Supervisor" - The person or juristic person appointed by the network operator from time to time as the Contract Supervisor, to administer the Contractor's performance and execution of the Works according to the powers and rights held by and obligations placed upon the Contract Supervisor in terms of the Contract.

"Dead" - Isolated and earthed.

"Electrical Officer (Contracts)" - The person appointed in writing by the Project Manager in terms of this specification as the person who shall be consulted by the Contractor in all electrical matters to ensure that adequate safety precautions are taken by the Contractor.

"Executive Officer" - The person appointed by the network operator from time to time as the Executive Officer to act according to the rights and powers held by and obligations placed upon him in terms of the Contract.

"High-Voltage" - A voltage normally exceeding 1000 volts.

"Live" - A conductor is said to be "live" when it is at a potential different from that of the earth or any other conductor of the system of which it forms a part.

"Near" - To be in such a position that a person's body or the tools he is using or any equipment he is handling may come within 3 metres of "live" exposed high-voltage electrical equipment.

"Occupation" - An authorisation granted by the network operator for work to be carried out under specified conditions on, over, under or adjacent to railway lines.

"Occupation Between Trains" - An occupation during an interval between successive trains.

"Optical Fibre Cable" - Buried or suspended composite cable containing optical fibres used in:

- telecommunication networks for transmission of digital information and
- safety sensitive train operations systems.

"Project Manager" - As defined in the special conditions of the contract. The person or juristic person appointed by the network operator from time to time as the Project Manager, to administer the Contract according to the powers and rights held by and obligations placed upon him in terms of the Contract.

"Responsible Representative" - The responsible person in charge, appointed by a contractor, who has undergone specific training (and holds a certificate) to supervise (general or direct) staff under his control who perform general work or to work on, over, under or adjacent to railway lines and in the vicinity of high-voltage electrical equipment.

"Total Occupation" - An occupation for a period when trains are not to traverse the section of line covered by the occupation.

"Work on" - Work undertaken on or so close to the equipment that the specified working clearances to the "live" equipment cannot be maintained.

"Work Permit" - A combined written application and authority to proceed with work on or near dead electrical equipment.

"Works" - The contractual intent for the work to be done as defined in the contract at a defined work site.

PART A - GENERAL SPECIFICATION**3.0 AUTHORITY OF OFFICERS OF TRANSNET**

- 3.1 The Contractor shall co-operate with the officers of the network operator and shall comply with all instructions issued and restrictions imposed with respect to the Works which bear on the existence and operation of the network operator's railway lines and high-voltage equipment.
- 3.2 Without limiting the generality of the provisions of clause 3.1, any duly authorised representative of the network operator, having identified himself, may stop the work if, in his opinion, the safe passage of trains or the safety of the network operator's assets or any person is affected. **CONSIDERATIONS OF SAFETY SHALL TAKE PRECEDENCE OVER ALL OTHER CONSIDERATIONS.**

4.0 CONTRACTOR'S REPRESENTATIVES AND STAFF

- 4.1 The Contractor shall nominate Responsible Representatives of whom at least one shall be available at any hour for call-out in cases of emergency. The Contractor shall provide the Contract Supervisor with the names, addresses and telephone numbers of the representatives.
- 4.2 The Contractor guarantees that he has satisfied himself that the Responsible Representative is fully conversant with this specification and that he shall comply with all his obligations in respect thereof.
- 4.3 The Contractor shall ensure that all contractor staff receives relevant awareness, educational and competence training regarding safety as prescribed.

5.0 OCCUPATIONS AND WORK PERMITS

- 5.1 Work to be done during total occupation or during an occupation between trains or under a work permit shall be done in a manner decided by the Contract Supervisor and at times to suit the network operator requirements.
- 5.2 The Contractor shall organise the Works in a manner which will minimise the number and duration of occupations and work permits required.
- 5.3 The network operator will not be liable for any financial or other loss suffered by the Contractor arising from his failure to complete any work scheduled during the period of an occupation or work permit.
- 5.4 The Contractor shall submit to the Contract Supervisor, in writing, requests for occupations or work permits together with details of the work to be undertaken, at least 21 days before they are required. The network operator does not undertake to grant an occupation or work permit for any particular date, time or duration.
- 5.5 The network operator reserves the right to cancel any occupation or work permit at any time before or during the period of occupation or work permit. If, due to cancellation or change in date or time, the Contractor is not permitted to start work under conditions of total occupation or work permit at the time arranged, all costs caused by the cancellation shall be born by the Contractor except as provided for in clauses 5.6 to 5.8.
- 5.6 When the Contractor is notified less than 2 hours before the scheduled starting time that the occupation or work permit is cancelled, he may claim reimbursement of his direct financial losses caused by the loss of working time up to the time his labour and plant are employed on other work, but not exceeding the period of the cancelled occupation or work permit.
- 5.7 When the Contractor is notified less than 2 hours before the scheduled starting time, or during an occupation or work permit, that the duration of the occupation or work permit is reduced, he may claim reimbursement of his direct financial losses caused by the loss of working time due to the reduced duration of the occupation or work permit.
- 5.8 Reimbursement of the Contractor for any loss of working time in terms of clause 5.6 and 5.7, shall be subject to his claims being submitted within 14 days of the event with full details of labour and plant involved, and provided that the Contract Supervisor certifies that no other work on which the labour and plant could be employed was immediately available.
- 5.9 Before starting any work for which an occupation has been arranged, the Contractor shall obtain from the Contract Supervisor written confirmation of the date, time and duration of the occupation.
- 5.10 Before starting any work for which a work permit has been arranged, the Responsible Representative shall read and sign portion C of the Work Permit, signifying that he is aware of the work boundaries within which work may be undertaken. After the work for which the permit was granted has been completed, or when the

work permit is due to be terminated, or if the permit is cancelled after the start, the same person who signed portion C shall sign portion D of the Work Permit, thereby acknowledging that he is aware that the electrical equipment is to be made "live". The Contractor shall advise all his workmen accordingly.

6.0 SPEED RESTRICTIONS AND PROTECTION

- 6.1 When speed restrictions are imposed by the network operator because of the Contractor's activities, the Contractor shall organise and carry out his work so as to permit the removal of the restrictions as soon as possible.
- 6.2 When the Contract Supervisor considers protection to be necessary the Contractor shall, unless otherwise agreed, provide all protection including flagmen, other personnel and all equipment for the protection of the network operator's and the Contractor's personnel and assets, the public and including trains.
- 6.2.1 The network operator will provide training free of charge of the Contractor's flagmen and other personnel performing protection duties. The Contractor shall consult with the Contract Supervisor, whenever he considers that protection will be necessary, taking into account the minimum permissible clearances set out in the Manual for Track Maintenance (Document no. BBB0481):
- Drawing no. BE-97 Sheet 1: Horizontal Clearances: 1065mm gauge (Annexure 1 sheet 1)
 - Drawing no. BE-97 Sheet 2: Vertical Clearances: 1065mm gauge (Annexure 1 sheet 2)
 - Drawing no. BE-97 Sheet 3: Clearances: Platform (Annexure 1 sheet 3)
 - Drawing no. BE-97 Sheet 5: Clearances: 610mm Gauge (Annexure 1 sheet 5)
- 6.3 The Contractor shall appoint a Responsible Representative to receive and transmit any instruction which may be given by the network operator personnel providing protection.

7.0 ROADS AND ROADS ON THE NETWORK OPERATOR'S PROPERTY

- 7.1 The Contractor shall take every reasonable precaution to prevent damage to any roads or bridges used to obtain access to the site, and shall select routes, use vehicles, and restrict loads so that any extraordinary traffic as may arise from the moving of plant or material to or from the site shall be limited as far as is reasonably possible.
- 7.2 The Contractor shall not occupy or interfere in any way with the free use of any public or private road, right-of-way, path or street unless the Contract Supervisor has obtained the approval of the road authority concerned.

8.0 CLEARANCES

- 8.1 No temporary works shall encroach on the appropriate minimum clearances set out in the Manual for Track Maintenance (Document no. BBB0481):
- Drawing no. BE-97 Sheet 1: Horizontal Clearances: 1065mm gauge (Annexure 1 sheet 1)
 - Drawing no. BE-97 Sheet 2: Vertical Clearances: 1065mm gauge (Annexure 1 sheet 2)
 - Drawing no. BE-97 Sheet 3: Clearances: Platform (Annexure 1 sheet 3)
 - Drawing no. BE-97 Sheet 5: Clearances: 610mm Gauge (Annexure 1 sheet 5)

9.0 STACKING OF MATERIAL

- 9.1 The Contractor shall not stack any material closer than 3m from the centre line of any railway line without prior approval of the Contract Supervisor.

10.0 EXCAVATION, SHORING, DEWATERING AND DRAINAGE

- 10.1 Unless otherwise approved by the Contract Supervisor any excavation adjacent to a railway line shall not encroach on the hatched area shown in Figure 1.

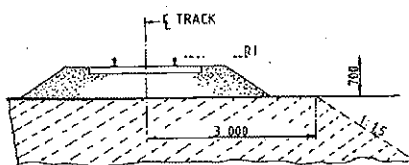

Fig. 1

- 10.2 The Contractor shall provide, at his own cost any shoring, dewatering or drainage of any excavation unless otherwise stipulated elsewhere in the Contract.
- 10.3 Where required by the Contract Supervisor, drawings of shoring for any excavation under or adjacent to a railway line shall be submitted and permission to proceed, obtained before the excavation is commenced.
- 10.4 The Contractor shall prevent ingress of water to the excavation but where water does enter, he shall dispose of it as directed by the Contract Supervisor.
- 10.5 The Contractor shall not block, obstruct or damage any existing drains either above or below ground level unless he has made adequate prior arrangements to deal with drainage.

11.0 FALSEWORK FOR STRUCTURES

- 11.1 Drawings of falsework for the construction of any structure over, under or adjacent to any railway line shall be submitted to the Contract Supervisor and his permission to proceed obtained before the falsework is erected. Each drawing shall be given a title and a distinguishing number and shall be signed by a registered professional engineer certifying that he has checked the design of the falsework and that the drawings are correct and in accordance with the design.
- 11.2 After the falsework has been erected and before any load is applied, the Contractor shall submit to the Contract Supervisor a certificate signed by a registered professional engineer certifying that he has checked the falsework and that it has been erected in accordance with the drawings. Titles and numbers of the drawings shall be stated in the certificate. Notwithstanding permission given by the Contract Supervisor to proceed, the Contractor shall be entirely responsible for the safety and adequacy of the falsework.

12.0 PILING

- 12.1 The Contract Supervisor will specify the conditions under which piles may be installed on the network operator's property.

13.0 UNDERGROUND SERVICES

- 13.1 No pegs or stakes shall be driven or any excavation made before the Contractor has established that there are no underground services which may be damaged thereby.
- 13.2 Any damage shall be reported immediately to the Contract Supervisor, or to the official in charge at the nearest station, or to the traffic controller in the case of centralised traffic control.

14.0 BLASTING AND USE OF EXPLOSIVES

- 14.1 When blasting within 500m of a railway line, the Contractor shall observe the requirements stipulated in this specification.
- 14.2 No blasting shall be carried out except with the prior written permission of the Contract Supervisor and under such conditions as he may impose.
- 14.3 On electrified lines the Contractor shall also obtain the permission of the Electrical Officer (Contracts) before blasting, and shall give at least 21 days notice of his intention to blast. No blasting shall be done in the vicinity of electrified lines unless a member of the network operator's electrical personnel is present.
- 14.4 The Contractor shall arrange for the supply, transport storage and use of explosives.
- 14.5 The Contractor shall have labour, tools and plant, to the satisfaction of the Contract Supervisor, available on the site to clear immediately any stones or debris deposited on the track or formation by blasting, and to repair any damage to the track or formation immediately after blasting. Repairs to the track shall be carried out only under the supervision of a duly authorised representative of the network operator.
- 14.6 The Contractor shall notify the Contract Supervisor of his intention to blast at least 21 days before the commencement of any blasting operations.
- 14.7 Before any blasting is undertaken, the Contractor and the Contract Supervisor shall jointly examine and measure up any buildings, houses or structures in the vicinity of the proposed blasting to establish the extent of any existing cracking or damage to such structures, etc. The Contractor, shall, subject to the provisions stipulated in the Contract Insurance Policy, make good any deterioration of such buildings, houses, or structures, which, in the opinion of the Contract Supervisor, was directly caused by the blasting.
- 14.8 After completion of the blasting the Contractor shall obtain a written clearance from each landowner in

the vicinity of the blasting operations to the effect that all claims for compensation in respect of damage caused by the blasting operations to their respective properties, have been settled.

14.9 The Contractor shall provide proof that he has complied with the provisions of clauses 10.17.1 to 10.17.4 of the Explosives Regulations (Act 26 of 1956 as amended).

14.10 Blasting within 500m of a railway line will only be permitted during intervals between trains. A person appointed by the Contract Supervisor, assisted by flagmen with the necessary protective equipment, will be in communication with the controlling railway station.

Only this person will be authorised to give the Contractor permission to blast, and the Contractor shall obey his instructions implicitly regarding the time during which blasting may take place.

14.11 The flagmen described in clause 14.10, where provided by the network operator, are for the protection of trains and the network operator's property only, and their presence does not relieve the Contractor in any manner of his responsibilities in terms of Explosives Act or Regulations, or any obligation in terms of this Contract.

14.12 The person described in clause 14.10 will record in a book provided and retained by the network operator, the dates and times:-

(i) when each request is made by him to the controlling station for permission to blast;

(ii) when blasting may take place;

(iii) when blasting actually takes place; and

(iv) when he advises the controlling station that the line is safe for the passage of trains.

14.13 Before each blast the Contractor shall record in the same book, the details of the blast to be carried out. The person appointed by the Contract Supervisor and the person who will do the blasting shall both sign the book whenever an entry described in clause 14.12 is made.

15.0 RAIL TROLLEYS

15.1 The use of rail trolleys or trestle trolleys on a railway line for working on high voltage equipment will be permitted only if approved by the Contract Supervisor and under the conditions stipulated by him.

15.2 All costs in connection with trolley working and any train protection services requested by the Contractor shall, be borne by the Contractor, unless otherwise agreed.

16.0 SIGNAL TRACK CIRCUITS

16.1 Where signal track circuits are installed, the Contractor shall ensure that no material capable of conducting an electrical current makes contact between rails of railway line/lines.

16.2 No signal connections on track-circuited tracks shall be severed without the Contract Supervisor's knowledge and consent.

17.0 PENALTY FOR DELAYS TO TRAINS

17.1 If any trains are delayed by the Contractor and the Contract Supervisor is satisfied that the delay was avoidable, a penalty will be imposed on the Contractor as stipulated in the contract, for the period and number of trains delayed.

18.0 SURVEY BEACONS AND PEGS

18.1 The Contractor shall not on any account move or damage any beacon, bench mark, reference mark, signal or trigonometrical station in the execution of the Works without the written approval of the Contract Supervisor.

Should the Contractor be responsible for any such occurrence, he shall report the circumstances to the Contract Supervisor who will arrange with the Director-General of Surveys for replacement of the beacon or mark at the cost of the Contractor.

18.2 The Contractor shall not move or damage any cadastral or mining beacon without the written approval of the Contract Supervisor and before it has been referenced by a registered land surveyor. Any old boundary beacon, which becomes an internal beacon on creation of new boundaries, shall not be moved without the written approval of the Contract Supervisor.

Should the Contractor move or damage any cadastral or mining beacon without authority, he shall be responsible for having it replaced, at his cost, by a land surveyor.

- 18.3 The Contractor shall preserve all pegs and bench marks. Such survey points shall not be removed without the written approval of the Contract Supervisor. Should any peg or benchmark be removed without authority, the Contract Supervisor will arrange for its replacement and the cost will be recovered from the Contractor. No claim will be considered for delay in replacing any such peg or bench mark. Each peg replaced shall be checked by the Contractor.
- 18.4 Where a new boundary has been established, beacons on the fence line shall not be disturbed, and fence posts or anchors may not be placed or excavations made within 0,6 m of any beacon without the prior written approval of the Contract Supervisor.

19.0 TEMPORARY LEVEL CROSSINGS

19.1 The Contract Supervisor may, on request of the Contractor, and if necessary for the purpose of execution of the Works, permit the construction of a temporary level crossing over a railway a line at a position approved by the Contract Supervisor and at the Contractor's cost. The period for which the temporary level crossing is permitted will be at the discretion of the Contract Supervisor.

19.2 The Contractor will provide protection and supervise the construction of the road over the track(s) and within the railway servitude at the level crossing, as well as the erection of all road signs and height gauges. All cost to be borne by the applicant.

The Contractor shall exercise extreme caution in carrying out this work, especially in respect of damage to tracks, services, overhead power and communications routes and prevent contact with "live" overhead electrical equipment.

Unless otherwise agreed, the Contractor will provide the service deviations or alterations to the network operator's track-, structure-, drainage-, electrical-, telecommunications- and train authorisation systems to accommodate the level crossing.

19.3 The Contractor shall take all necessary steps including the provision of gates, locks and, where necessary, watchmen to restrict the use of the temporary level crossing to himself and his employees, his subcontractors and their employees, the staff of the network operator and to such other persons as the Contract Supervisor may permit and of whose identity the Contractor will be advised. If so ordered by the Contract Supervisor, the Contractor shall provide persons to control road traffic using the temporary level crossing. Such persons shall stop all road traffic when any approaching train is within seven hundred and fifty (750) metres of the temporary level crossing, and shall not allow road traffic to proceed over it until the lines are clear.

19.4 The Contractor shall maintain the temporary level crossing within the railway servitude in good condition for the period it is in use. A temporary agreement with the road authority to be concluded for the maintenance of the level crossing outside the railway servitude.

19.5 When the temporary level crossing is no longer required by the Contractor, or permitted by the network operator, the Contractor shall at his own cost remove it and restore the site and the network operator's track-, structure-, drainage-, electrical-, telecommunications- and train authorisation systems to its original condition. Work over the tracks and within the railway servitude will be supervised by the network operator.

20.0 COMPLETION OF THE WORKS

20.1 On completion of the works, the Contractor shall remove all the remaining construction plant and material from the site, other than material which is the property of the network operator, and leave the site in a clean, neat and tidy condition. If material and plant is required for the liability and maintenance period the Contract supervisor must authorise it's retention on site.

21.0 PROTECTION OF PERSONS AND PROPERTY

21.1 The Contractor shall provide and maintain all lights, guards, barriers, fencing and watchmen when and where necessary or as required by the Contract Supervisor or by any statutory authority, for the protection of the Works and for the safety and convenience of the public.

Red, yellow, green or blue lights may not be used by the Contractor as they can be mistaken for signals. Red, yellow, green or white flags shall only be used for protection by the Contractor. Within the precincts of a port the Contractor shall obtain the permission of the Port Captain before installing any light.

- 21.2 The Contractor shall take all the requisite measures and precautions during the course of the Works to:
- (i) protect the public and property of the public,
 - (ii) protect the property and workmen of both the network operator and the Contractor,
 - (iii) avoid damage to and prevent trespass on adjoining properties, and
 - (iv) ensure compliance with any instruction issued by the Contract Supervisor or other authorised person, and with any stipulation embodied in the contract documents which affects the safety of any person or thing.
- 21.3 The network operator will provide, at its own cost, protection for the safe working of trains during such operations as the Contract Supervisor may consider necessary. Protection by the network operator for any purpose whatsoever, does not absolve the Contractor of his responsibilities in terms of the Contract.
- 21.4 The Contractor shall take all precautions and appoint guards, watchmen and compound managers for prevention of disorder among and misconduct by the persons employed on the Works and by any other persons, whether employees or not, on the work site and for the preservation of the peace and protection of persons and property in the direct neighbourhood. Any relocation of camps because of disorder shall be at the Contractor's expense.
- 21.5 All operations necessary for the execution of the Works, including the provision of any temporary work and camping sites, shall be carried out so as not to cause veldt fires, ground and environmental pollution, soil erosion or restriction of or interference with streams, furrows, drains and water supplies.
- If the original surface of the ground is disturbed in connection with the Works, it shall be made good by the Contractor to the satisfaction of the land owner, occupier or responsible authority.
- 21.6 The Contractor shall take all reasonable steps to minimise noise and disturbance when carrying out the Works, including work permitted outside normal working hours.
- 21.7 Dumping of waste or excess materials by the Contractor shall, in urban areas, be done under the direction and control of, and at sites made available by the local authority. Dumping outside local authority boundaries shall be done only with the express permission and under the direction and control of the Contract Supervisor.
- 21.8 The Contractor shall comply with environmental protection measures and specifications stipulated by the Contract Supervisor and/or local and environmental authorities.
- 22.0 INTERFERENCE WITH THE NETWORK OPERATOR'S ASSETS AND WORK ON OPEN LINES**
- 22.1 The Contractor shall not interfere in any manner whatsoever with an open line, nor shall he carry out any work or perform any act which affects the security, use or safety of an open line except with the authority of the Contract Supervisor and in the presence of a duly authorised representative of the network operator.
- 22.2 The Contractor shall not carry out any work or operate any plant, or place any material whatsoever nearer than three metres from the centre line of any open line except with the written permission of the Contract Supervisor and subject to such conditions as he may impose.
- 22.3 Care must be taken not to interfere with or damage any services such as overhead wire routes, cables or pipes and optical fibre cable, except as provided for the work specified. The Contractor will be held responsible for any damage to or interruption of such services arising from any act or omission on his part or of any of his employees, or persons engaged by him on the Works. The cost of repairing, replacing or restoring the services, as well as all other costs arising from any damage to services, shall be borne by, and will be recovered from the Contractor.
- 22.4 Authority granted by the Contract Supervisor and the presence of an authorised representative of the network operator in terms hereof, shall not relieve the Contractor of his duty to comply with this specification.
- 23.0 ACCESS, RIGHTS-OF-WAY AND CAMPSITES**
- 23.1 Where entry onto the network operator's property is restricted, permission to enter will be given only for the purpose of carrying out the Works and will be subject to the terms and conditions laid down by the network operator.
- 23.2 The Contractor shall arrange for campsites, workplaces and access thereto as well as for any right-of-

way over private property to the site of the Works, and for access within the boundaries of the network operator's property. The owners of private property to be traversed shall be approached and treated with tact and courtesy by the Contractor, who shall, if necessary, obtain a letter of introduction to such property owners from the Contract Supervisor.

The Contractor shall be responsible for the closing of all gates on roads and tracks used by him or his employees. Except with the prior approval of the Contract Supervisor and the owner or occupier of any private land to be traversed, the Contractor shall not cut, lower, damage, remove or otherwise interfere with any fence or gate which is either on the network operator's property or on private property and which restricts access to the Works. Where such approval has been given, the Contractor shall prevent entry of animals or unauthorised persons onto the network operator's or private property, and shall make the fences safe against trespass at the close of each day's work.

- 23.3 The Contractor shall take all reasonable steps to confine the movement of vehicles and plant to the approved right-of-way to minimise damage to property, crops and natural vegetation.
- 23.4 When access is no longer required, and before completion of the Works, the Contractor shall repair, restore or replace any fence or gate damaged during execution of the Works to the satisfaction of the Contract Supervisor and shall furnish the Contract Supervisor with a certificate signed by the owner and occupier of land over which he has gained access to a campsite, workplace and the Works, certifying that the owner and occupier have no claim against the Contractor or the network operator arising from the Contractor's use of the land. Should the Contractor be unable to obtain the required certificate, he shall report the circumstances to the Contract Supervisor.

24.0 SUPERVISION

- 24.1 The Contract Supervisor will provide overall technical superintendence of the Works, and may direct the Contractor in terms of the provisions of the Contract or in respect of any measures which the Contract Supervisor may require for the operations of the network operator, the safety of trains, property and workmen of the network operator, and for the safety of other property and persons. The Contractor shall carry out the directions of the Contract Supervisor. The superintendence exercised by the Contract Supervisor, including any agreement, approval, refusal or withdrawal of any approval given, shall not relieve the Contractor of any of his duties and liabilities under the Contract, and shall not imply any assumption by the network operator or by the Contract Supervisor of the legal and other responsibilities of the Contractor in carrying out the Works.
- 24.2 The Contract Supervisor may delegate to any deputy or other person, any of his duties or functions under the Contract. On receiving notice in writing of such delegation, the Contractor shall recognise and obey the deputy or person to whom any such duties or functions have been delegated as if he were the Contract Supervisor.
- 24.3 The Contractor shall exercise supervision over the Works at all times when work is performed or shall be represented by an agent having full power and authority to act on behalf of the Contractor. Such agent shall be competent and responsible, and have adequate experience in carrying out work of a similar nature to the Works, and shall exercise personal supervision on behalf of the Contractor. The Contract Supervisor shall be notified in writing of such appointment which will be subject to his approval.
- 24.4 The Contractor or his duly authorised agent shall be available on the site at all times while the Works are in progress to receive the orders and directions of the Contract Supervisor.

25.0 HOUSING OF EMPLOYEES

- 25.1 The Contractor shall, where necessary, make his own arrangements for suitable housing of his employees. Where temporary housing is permitted by the Contract Supervisor on any part of the site, the Contractor shall provide suitable sanitation, lighting and potable water supplies in terms of the requirements of the local authority or the current network operator's specification; Minimum Communal Health Requirements in Areas outside the Jurisdiction of a Local Authority - E.4B, as applicable.
- 25.2 Fouling the area inside or outside the network operator's boundaries shall be prevented. The Contractor will be called upon by the Contract Supervisor to dispose of any foul or waste matter generated by the Contractor.

26.0 OPTICAL FIBRE CABLE ROUTES

- 26.1 The Contractor shall not handle, impact, move or deviate any optical fibre cable without prior approval.
- 26.2 Works that in any way affect the optical fibre cable requires prior approval from the Contract Supervisor

who will determine the work method and procedures to be followed.

"PREVIEW COPY ONLY"

PART B - SPECIFICATION FOR WORK NEAR HIGH-VOLTAGE ELECTRICAL EQUIPMENT
27.0 GENERAL

27.1 This specification is based on the contents of Transnet's publication ELECTRICAL SAFETY INSTRUCTIONS, as amended, a copy of which will be made available on loan to the Contractor for the duration of the contract.

These instructions apply to all work near "live" high-voltage equipment maintained and/or operated by the network operator, and the onus rests on the Contractor to ensure that he obtains a copy.

27.2 This specification must be read in conjunction with and not in lieu of the Electrical Safety Instructions.

27.3 The Contractor's attention is drawn in particular to the contents of Part I, Sections 1 and 2 of the Electrical Safety Instructions.

27.4 The Electrical Safety Instructions cover the minimum safety precautions which must be taken to ensure safe working on or near high-voltage electrical equipment, and must be observed at all times. Should additional safety measures be considered necessary because of peculiar local conditions, these may be ordered by and at the discretion of the Electrical Officer (Contracts).

27.5 The Contractor shall obtain the approval of the Electrical Officer (Contracts) before any work is done which causes or could cause any portion of a person's body or the tools he is using or any equipment he is handling, to come within 3 metres of any "live" high-voltage equipment.

27.6 The Contractor shall regard all high-voltage equipment as "live" unless a work permit is in force.

27.7 Safety precautions taken or barriers erected shall comply with the requirements of the Electrical Officer (Contracts), and shall be approved by him before the work to be protected is undertaken by the Contractor. The Contractor shall unless otherwise agreed, bear the cost of the provision of the barriers and other safety precautions required, including the attendance of the network operator's staff where this is necessary.

27.8 No barrier shall be removed unless authorised by the Electrical Officer (Contracts).

28.0 WORK ON BUILDINGS OR FIXED STRUCTURES

28.1 Before any work is carried out or measurements are taken on any part of a building, fixed structure or earthworks of any kind above ground level situated within 3 metres of "live" high-voltage equipment, the Electrical Officer (Contracts) shall be consulted to ascertain the conditions under which the work may be carried out.

28.2 No barrier erected to comply with the requirements of the Electrical Officer (Contracts) shall be used as temporary staging or shuttering for any part of the Works.

28.3 The shuttering for bridge piers, abutments, retaining walls or parapets adjacent to or over any track may be permitted to serve as a barrier, provided that it extends at least 2,5 metres above any working level in the case of piers, abutments and retaining walls and 1,5 metres above any working level in the case of parapets.

29.0 WORK DONE ON OR OUTSIDE OF ROLLING STOCK, INCLUDING LOADING OR UNLOADING

29.1 No person may stand, climb or work, whilst on any platform, surface or foothold:

29.1.1 higher than the normal unrestricted access way, namely -

29.1.1.1 external walkways on diesel, steam and electric locomotives, steam heat vans, etc. and

29.1.1.2 walkways between coaches and locomotives.

29.1.2 of restricted access ways in terms of the Electrical Safety Instructions namely -

29.1.2.1 the floor level of open wagons

29.1.2.2 external walkways or decks of road-rail vehicles, on-track maintenance machines and material trains.

29.1.3 Unauthorised staff working on these platforms must be directly supervised by duly authorised persons in terms of clause 607.1.3 of the Electrical Safety Instructions. These persons must attend the relevant electrical safety module training. A letter of training must then be issued by an accredited training authority. A Category C Certificate of Authority must be obtained from the

local depot examining officer.

- 29.2 When in the above positions no person may raise his hands or any equipment he is handling above his head.
- 29.3 In cases where the Contractor operates his own rail mounted equipment, he shall arrange for the walkways on this plant to be inspected by the Electrical Officer (Contracts) and approved, before commencement of work.
- 29.4 The handling of long lengths of material such as metal pipes, reinforcing bars, etc should be avoided, but if essential they shall be handled as nearly as possible in a horizontal position below head height.
- 29.5 The Responsible Representative shall warn all persons under his control of the danger of being near "live" high-voltage equipment, and shall ensure that the warning is fully understood.
- 29.6 Where the conditions in clauses 30.1 to 30.4 cannot be observed the Electrical Officer (Contracts), shall be notified. He will arrange for suitable Safety measures to be taken. The Electrical Officer (Contracts), may in his discretion and in appropriate circumstances, arrange for a suitable employee of the Contractor to be specially trained by the network operator and at the Contractor's cost, as an Authorised Person to work closer than 3 metres from "live" overhead conductors and under such conditions as may be imposed by the senior responsible electrical engineer of the network operator.

30.0 USE OF EQUIPMENT

30.1 Measuring Tapes and Devices

- 30.1.1 Measuring tapes may be used near "live" high-voltage equipment provided that no part of any tape or a person's body comes within 3 metres of the "live" equipment.
- 30.1.2 In windy conditions the distance shall be increased to ensure that if the tape should fall it will not be blown nearer than 3 metres from the "live" high-voltage equipment.
- 30.1.3 Special measuring devices longer than 2 metres such as survey sticks and rods may be used if these are of non-conducting material and approved by the responsible Electrical Engineer of the network operator, but these devices must not be used within 3 metres of "live" high-voltage equipment in rainy or wet conditions.
- 30.1.4 The assistance of the Electrical Officer (Contracts) shall be requested when measurements within the limits defined in clauses 31.1.1 to 31.1.3 are required.
- 30.1.5 The restrictions described in 31.1.1 to 31.1.3 do not apply on a bridge deck between permanent parapets nor in other situations where a barrier effectively prevents contact with the "live" high-voltage equipment.

30.2 Portable Ladders

- 30.2.1 Any type of portable ladder longer than 2 metres may only be used near "live" high-voltage equipment under the direct supervision of the Responsible Representative. He shall ensure that the ladder is always used in such a manner that the distance from the base of the ladder to any "live" high-voltage equipment is greater than the fully extended length of the ladder plus 3 metres. Where these conditions cannot be observed, the Electrical Officer (Contracts) shall be advised, and he will arrange for suitable safety measures to be taken.

31.0 CARRYING AND HANDLING MATERIAL AND EQUIPMENT

- 31.1 Pipes, scaffolding, iron sheets, reinforcing bars and other material which exceeds 2 metres in length shall be carried completely below head height near "live" high-voltage equipment. For maximum safety such material should be carried by two or more persons so as to maintain it as nearly as possible in a horizontal position. The utmost care must be taken to ensure that no part of the material comes within 3 metres of any "live" high-voltage equipment.
- 31.2 Long lengths of wire or cable shall never be run out in conditions where a part of a wire or cable can come within 3 metres of any "live" high-voltage equipment unless the Electrical Officer (Contracts) has been advised and has approved appropriate safety precautions.
- 31.3 The presence of overhead power lines shall always be taken account of especially when communications lines or cables or aerial cables, stay wires, etc. are being erected above ground level.

32.0 PRECAUTIONS TO BE TAKEN WHEN ERECTING OR REMOVING POLES, ANTENNAE, TREES ETC.

- 32.1 A pole may be handled for the purpose of erection or removal near high-voltage equipment under the following conditions:

(i) If the distance between the point at which the pole is to be erected or removed and the nearest "live" high-voltage equipment is more than the length of the pole plus 3 metres, the work shall be supervised by the Responsible Representative.

(ii) If the distance described in (i) is less than the length of the pole plus 3 metres, the Electrical Officer (Contracts) shall be consulted to arrange for an Authorised Person to supervise the work and to ensure that the pole is earthed where possible. The pole shall be kept in contact with the point of erection, and adequate precautions shall be taken to prevent contact with "live" high-voltage equipment.

32.2 The cost of supervision by an Authorised Person and the provision of earthing shall, unless otherwise agreed, be borne by the Contractor.

32.3 The provisions of clauses 33.1 and 33.2 shall also apply to the erection or removal of columns, antennae, trees, posts, etc.

33.0 USE OF WATER

33.1 No water shall be used in the form of a jet if it can make contact with any "live" high-voltage equipment or with any person working on such equipment.

34.0 USE OF CONSTRUCTION PLANT

34.1 "Construction plant" entails all types of plant including cranes, piling frames, boring machines, excavators, draglines, dewatering equipment and road vehicles with or without lifting equipment.

34.2 When work is being undertaken in such a position that it is possible for construction plant or its load to come within 3 metres of "live" high-voltage equipment, the Electrical Officer (Contracts) shall be consulted. He will arrange for an Authorised Person to supervise the work and to ensure that the plant is adequately earthed. The Electrical Officer (Contracts) will decide whether further safety measures are necessary.

34.3 The cost of any supervision by an Authorised Person and the provision of earthing shall, unless otherwise agreed, be borne by the Contractor.

34.4 When loads are handled by cranes, non-metallic rope hand lines shall be used, affixed to such loads so as to prevent their swinging and coming within 3 metres of "live" high-voltage equipment.

34.5 Clauses 35.1 to 35.4 shall apply *mutatis mutandis* to the use of maintenance machines of any nature.

35.0 WORK PERFORMED UNDER DEAD CONDITIONS UNDER COVER OF A WORK PERMIT

35.1 If the Responsible Representative finds that the work cannot be done in safety with the high-voltage electrical equipment "live", he shall consult the Electrical Officer (Contracts) who will decide on the action to be taken.

35.2 If a work permit is issued the Responsible Representative shall-

(i) before commencement of work ensure that the limits within which work may be carried out have been explained to him by the Authorised Person who issued the permit to him, and that he fully understands these limits.

(ii) sign portion C of the permit before commencement of work;

(iii) explain to all persons under his control the limits within which work may be carried out, and ensure that they fully understand these limits;

(iv) care for the safety of all persons under his control whilst work is in progress; and

(v) withdraw all personnel under his control from the equipment on completion of the work before he signs portion D of the work permit.

36.0 TRACTION RETURN CIRCUITS IN RAILS

36.1 DANGEROUS CONDITIONS CAN BE CREATED BY REMOVING OR SEVERING ANY BOND.

36.2 Broken rails with an air gap between the ends, and joints at which fishplates are removed under "broken bond" conditions, are potentially lethal. The rails on either side of an air gap between rail ends on electrified lines shall not be touched simultaneously until rendered safe by the network operator personnel.

36.3 The Contractor shall not break any permanent bonds between rails or between rails and any structure. He shall give the Contract Supervisor at least 7 days written notice when removal of such bonds is necessary.

36.4 No work on the track which involves interference with the traction return rail circuit either by cutting or removing the rails, or by removal of bonds shall be done unless the Electrical Officer (Contracts) is consulted. He will take such precautions as may be necessary to ensure continuity of the return circuit before permitting the work to be commenced.

37.0 HIGH-VOLTAGE ELECTRICAL EQUIPMENT NOT MAINTAINED AND/OR OPERATED BY THE NETWORK OPERATOR

Where the work is undertaken on or near high-voltage electrical equipment which is not maintained and/or operated by the network operator, the Occupational Health and Safety Act No. 85 of 1993, and Regulations and Instructions, or the Mines Health and Safety Act (Act 29 of 1996), shall apply.

Such equipment includes:-

- (i) Eskom and municipal equipment;
- (ii) The Contractor's own power supplies; and
- (iii) Electrical equipment being installed but not yet taken over from the Contractor.

END

"PREVIEW COPY ONLY"

HORIZONTAL CLEARANCES :
1 065mm TRACK GAUGE

ANNEXURE 1
SHEET 1 of 5

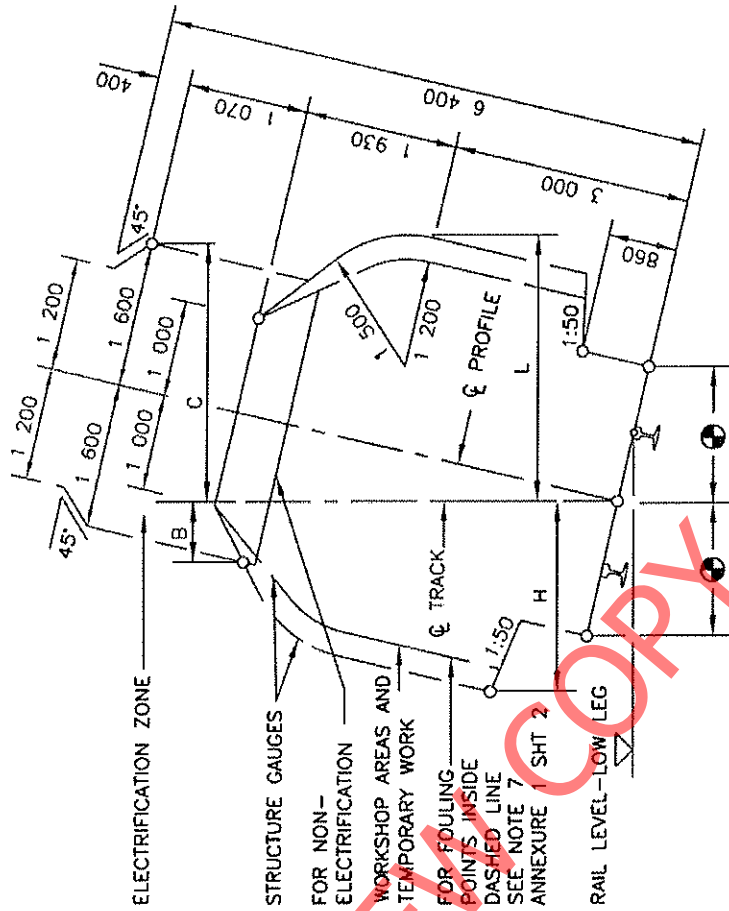

RADIUS (m)	WITH CANT		NO CANT		WITH CANT	
	H (mm)	L (mm)	H & L	B (mm)	C (mm)	C (mm)
90	2 730	3 090	2 780	1 130	2 100	2 100
100	2 700	3 030	2 750	1 140	2 050	2 050
120	2 650	2 970	2 700	1 160	2 010	2 010
140	2 620	2 920	2 660	1 175	1 990	1 990
170	2 590	2 870	2 630	1 190	1 970	1 970
200	2 570	2 820	2 600	1 205	1 950	1 950
250	2 550	2 790	2 580	1 230	1 920	1 920
300	2 540	2 760	2 560	1 250	1 900	1 900
350	2 530	2 730	2 540	1 270	1 890	1 890
400	2 520	2 710	2 530	1 290	1 875	1 875
500	2 510	2 680	2 520	1 320	1 850	1 850
600	2 500	2 660	2 510	1 340	1 830	1 830
800	2 490	2 620	2 500	1 365	1 790	1 790
1 000	2 480	2 600	2 490	1 380	1 760	1 760
1 200	2 480	2 580	2 490	1 200	1 730	1 730
1 500	2 480	2 550	2 480	1 415	1 700	1 700
2 000	2 480	2 500	2 480	1 440	1 660	1 660
3 000	2 470	2 470	2 470	1 500	1 600	1 600
>5 000	2 460	2 460	2 460	1 600	1 600	1 600

REMARKS:

- H AND B IS THE REQUIRED HORIZONTAL CLEARANCE ON THE HIGH LEG OF THE CURVE BASED ON MINIMUM CANT.
- L AND C IS THE REQUIRED HORIZONTAL CLEARANCE ON THE LOW LEG OF THE CURVE BASED ON MAXIMUM CANT.
- INTERMEDIATE VALUES MAY BE INTERPOLATED BY THE ENGINEER IN CHARGE.
- FOR WORKSHOP AREAS AND TEMPORARY WORK, CLEARANCES H AND L MAY BE REDUCED BY 300mm.
- SEE ANNEXURE 1 SHEET 3 FOR PLATFORM CLEARANCES.
- ALSO REFER TO REMARKS 4 TO 8 OF ANNEXURE 1 SHEET 2.
- USE SMALLER RADIUS IF RADIUS IN BETWEEN

VERTICAL CLEARANCES :
1 065mm TRACK GAUGE

ANNEXURE 1
SHEET 2 of 5

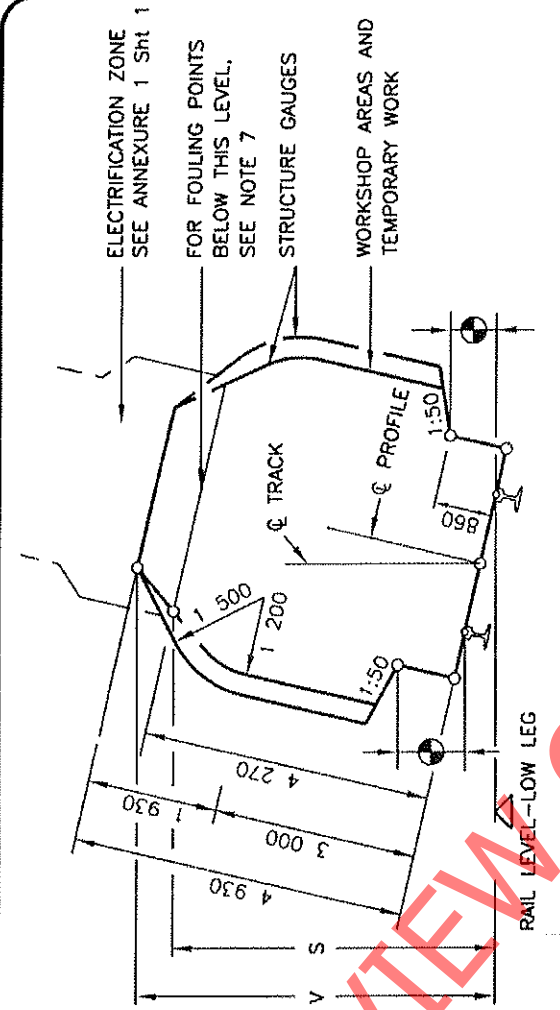

LOCATION	NOT ELECTRIFIED	ELECTRIFIED (PRESENT OR FUTURE)	
		3kV & 2.5kV	50kV
RADIUS (mm)	S (mm)	V (mm)	V (mm)
	100	4 470	5 400
	300	4 410	5 370
	600	4 370	5 350
	1 000	4 350	5 340
	1 500	4 310	5 310
	2 000	4 290	5 290
>3 000	4 270	4 930	5 280
* OVER OR NEAR POINTS AND CROSSING IF REQUIRED BY ELECTRICAL IRRESPECTIVE OF RADIUS		5 650	6 000

ALL AREAS OTHER THAN THOSE INDICATED BY * BELOW

REMARKS:

1. V IS THE REQUIRED VERTICAL CLEARANCE EXCEPT WHERE REDUCED CLEARANCE S APPLIES.
2. S IS THE MINIMUM VERTICAL CLEARANCE FOR STRUCTURES AND TEMPORARY WORK OVER NON-ELECTRIFIED LINES.
3. INTERMEDIATE VALUES MAY BE INTERPOLATED BY THE ENGINEER IN CHARGE.
4. FOR APPLICATION AT CURVES
 - 4.1 APPLY INCREASED CLEARANCES FOR CURVES TO POINTS 3m BEYOND THE ENDS OF THE CIRCULAR CURVE.
 - 4.2 REDUCE CLEARANCES AT A UNIFORM RATE OVER THE REMAINDER OF THE TRANSITION CURVE.
 - 4.3 FOR NON-TRANSITIONED CURVES REDUCE AT A UNIFORM RATE OVER A LENGTH OF 15m ALONG STRAIGHTS.
5. NEW STRUCTURES: SEE BRIDGE CODE.
6. TUNNELS: SEE DRAWING BE 82-35.
7. FOULING POINTS: SEE CLAUSE 8.1.
8. CLEARANCES ARE BASED ON 15m BOGIE CENTRES AND 21.2m VEHICLE BODY LENGTH.
9. SEE ANNEXURE 1 SHEET 3 FOR PLATFORM CLEARANCES.

CLEARANCES : PLATFORMS

ANNEXURE 1
SHEET 3 of 5

PLATFORMS : TRACK GAUGE 1 065mm

PASSENGERS

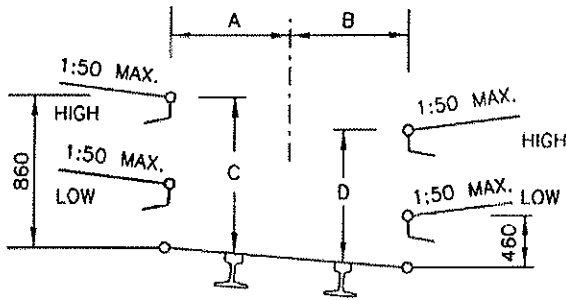

GOODS

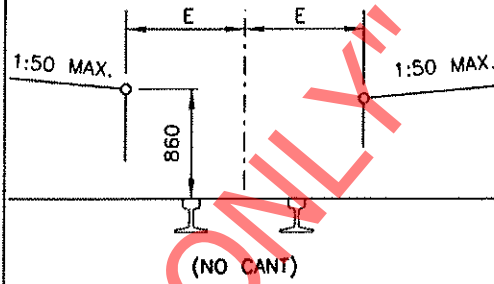

RADIUS (m)	A (mm)	B (mm)	C (mm)	D (mm)	E (mm)
90	1 690	1 820	890	810	1 840
100	1 650	1 790	890	810	1 810
120	1 610	1 740	890	810	1 760
140	1 580	1 700	890	810	1 720
170	1 550	1 660	890	810	1 690
200	1 530	1 630	890	820	1 670
250	1 520	1 600	890	820	1 640
300	1 520	1 580	890	830	1 620
350	1 520	1 560	880	830	1 600
400	1 520	1 550	880	840	1 590
500	1 520	1 540	880	850	1 580
600	1 520	1 530	870	850	1 570
800	1 520	1 520	860	860	1 560
1 200	1 520	1 520	860	860	1 550
2 000	1 520	1 520	860	860	1 540
3 000	1 520	1 520	860	860	1 530
STRAIGHT	1 520	1 520	860	860	1 520

REMARKS:

1. NO CANT TO BE APPLIED EXCEPT WHEN THE GOODS PLATFORM IS ON A RUNNING LINE.
2. INTERMEDIATE VALUES MAY BE INTERPOLATED BY THE ENGINEER IN CHARGE.
3. 8m TO MAIN STATION-BUILDINGS AND 3m TO ALL OTHER STRUCTURES.
4. TOLERANCES : SEE CLAUSE 8.0.10.
5. ALWAYS USE THE SMALLEST RADIUS

STRUCTURES ON PLATFORMS : 1 065mm AND 610mm TRACK GAUGE

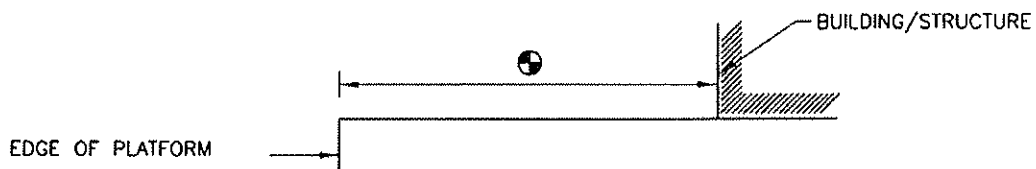

CLEARANCES : 610mm TRACK GAUGE

ANNEXURE 1
SHEET 5 of 5

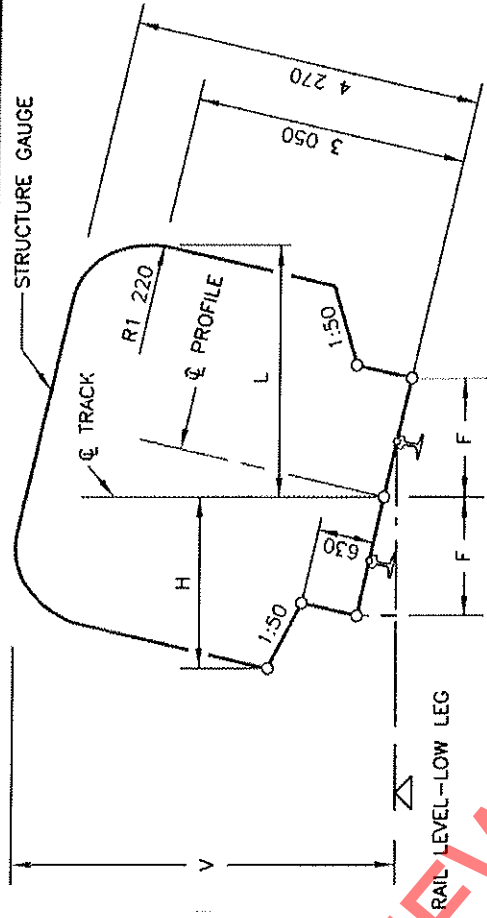

RADIUS (m)	F (mm)
50	1 550
60	1 510
80	1 460
100	1 430
120	1 410
140	1 390
170	1 380
200	1 370
250	1 360
300	1 350
600	1 330
1 000	1 320
>2 000	1 320
STRAIGHT	1 310

RADIUS (m)	WITH CANT		NO CANT		V (mm)
	H (mm)	L (mm)	H & L (mm)		
50	2 370	2 490	2 400	4 320	4 320
70	2 310	2 420	2 330	4 310	4 310
100	2 260	2 370	2 280	4 310	4 310
140	2 220	2 340	2 250	4 310	4 310
200	2 200	2 300	2 220	4 300	4 300
300	2 190	2 270	2 200	4 300	4 300
500	2 180	2 230	2 190	4 290	4 290
700	2 170	2 200	2 180	4 270	4 270
1 000	2 170	2 170	2 170	4 270	4 270
>2 000	2 160	2 160	2 160	4 270	4 270

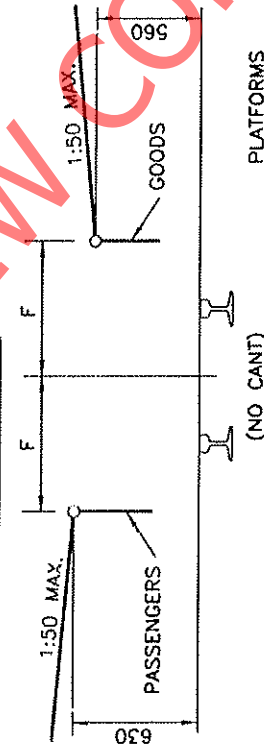

REMARKS:

- H IS THE MINIMUM HORIZONTAL CLEARANCE ON THE OUTSIDE OF THE CURVE BASED ON MINIMUM CANT.
- L IS THE MINIMUM HORIZONTAL CLEARANCE ON THE INSIDE OF THE CURVE BASED ON MAXIMUM CANT.
- V IS THE MINIMUM VERTICAL CLEARANCE.
- FOR APPLICATION AT CURVES:
 - APPLY INCREASED CLEARANCES FOR CURVES TO POINTS 2m BEYOND THE ENDS OF THE CIRCULAR CURVE.
 - REDUCE CLEARANCES AT A UNIFORM RATE OVER THE REMAINDER OF THE TRANSITION CURVE.
 - FOR NON-TRANSITIONED CURVES REDUCE AT A UNIFORM RATE OVER A LENGTH OF 18m ALONG STRAIGHTS.
- INTERMEDIATE VALUES MAY BE INTERPOLATED BY THE ENGINEER IN CHARGE.
- ALSO REFER TO REMARKS 5, 6 AND 7 OF ANNEXURE 1 SHEET 2.
- CLEARANCES ARE BASED ON 9 700mm BOGIE CENTRES AND 13 700mm VEHICLE BODY LENGTH.
- SEE ANNEXURE 1 SHEET 3 FOR STRUCTURES ON PLATFORMS.