



Transnet Freight Rail, a division of

**TRANSNET SOC LTD**

Registration Number 1990/000900/30  
[hereinafter referred to as **Transnet**]

**REQUEST FOR QUOTATION [RFQ] No RME CPT 054/2014**

**FOR THE SUPPLY AND DELIVERY OF: TRACK SWITCH EQUIPMENT**

**FOR DELIVERY TO: BELLVILLE SQUARE STORES, CAPE TOWN**

**ISSUE DATE: 03 MARCH 2014**

**CLOSING DATE: 13 MARCH 2014**

**CLOSING TIME: 10:00**

**PREVIEW COPY ONLY!!!**

**Section 1**  
**NOTICE TO BIDDERS**

Quotations which must be completed as indicated in Section 2 of this RFQ are to be submitted as follows:

**METHOD:** Post; Courier or Hand Deliver  
**CLOSING VENUE:** SEE BELOW FOR CLOSING VENUE

**1 Responses to RFQ**

Responses to this RFQ [**Quotations**] must not include documents or reference relating to any other quotation or proposal. Any additional conditions must be embodied in an accompanying letter. Proposals must reach the Secretariat, Acquisition Council before the closing hour on the date shown below, and must be enclosed in a sealed envelope which must have inscribed on the outside:

**RFQ No:** RME CPT 054/2014

**Description:** SUPPLY AND DELIVERY OF TRACK SWITCH EQUIPMENT

**Closing date and time:** 23 MARCH 2014 AT 10H00 Sharp

**Closing address** [Refer to options in Delivery Instructions for RFQ below]

All envelopes must reflect the return address of the Respondent on the reverse side.

**1 DELIVERY INSTRUCTIONS FOR RFQ**

**1.1 Delivery by hand**

If delivered by hand, the envelope is to be deposited in the Transnet Freight Rail (RME) Tender box which is located at the main entrance of Transnet Park, Robert Sobukwe Road, Bellville, and should be addressed as follows:

THE SECRETARIAT  
ACQUISITION COUNCIL  
TRANSNET PARK  
TENDER BOX 2  
ROBERT SOBUKWE ROAD  
BELLVILLE 7535

The measurements of the "tender slot" are 400mm wide x 100mm high, and Respondents must please ensure that response documents or files are no larger than the above dimensions. Responses which are too bulky [i.e. more than 100mm thick] must be split into two or more files, and placed in separate envelopes, each such envelope to be addressed as above.

**1.2 Dispatch by courier**

If dispatched by courier, the envelope must be addressed as follows and delivered to the Office of The Secretariat, Acquisition Council and a signature obtained from that Office:

THE SECRETARIAT  
TRANSNET ACQUISITION COUNCIL

Respondent's Signature

Date & Company Stamp

6TH FLOOR  
TRANSNET PARK  
ROBERT SOBUKWE ROAD  
BELLVILLE 7535

Please note that this RFQ closes punctually at **10:00 on Thursday 13 March 2014**.

1. If responses are not delivered as stipulated herein, such responses will not be considered and will be treated as "NON-RESPONSIVE" and will be disqualified.
2. No email or facsimile responses will be considered, unless otherwise stated herein.
3. The responses to this RFQ will be opened as soon as practicable after the expiry of the time advertised for receiving them.
4. Transnet shall not, at the opening of responses, disclose to any other company any confidential details pertaining to the Proposals / information received, i.e. pricing, delivery, etc. The names and locations of the Respondents will be divulged to other Respondents upon request.
5. Envelopes must not contain documents relating to any RFQ other than that shown on the envelope.

## 2 Broad-Based Black Economic Empowerment [B-BBEE]

Transnet fully endorses and supports the Government's Broad-Based Black Economic Empowerment Programme and it would therefore prefer to do business with local business enterprises who share these same values. Transnet will accordingly allow a "preference" to companies who provide a valid B-BBEE Verification Certificate. All procurement transactions will be evaluated accordingly.

### 2.1 B-BBEE Scorecard and Rating

As prescribed in terms of the Preferential Procurement Policy Framework Act (PPPFA), Act 5 of 2000 and its Regulations, Respondents are to note that the following preference point systems are applicable to all bids:

- the 80/20 system for requirements with a Rand value of above R1 000 000 (all applicable taxes included); and
- the 90/10 system for requirements with a Rand value above R1 000 000 (all applicable taxes included).
- Bidders are to note that if the 80/20 preference point system is stipulated in this RFQ and all Bids received exceed R1 000 000.00, the RFQ must be cancelled. Similarly, if the 90/10 preference point system is stipulated in this RFQ and all Bids received are equal to or below R1 000 000.00, the RFQ must be cancelled.

The value of this bid is estimated to exceed R1 000 000.00 and therefore the **90/10** system shall be applicable. When Transnet invites prospective suppliers to submit Proposals for its various expenditure programmes, it requires Respondents to have their B-BBEE status verified in compliance with the Codes of Good Practice issued in terms of the Broad Based Black Economic Empowerment Act No. 53 of 2003.

The Department of Trade and Industry recently revised the Codes of Good Practice on 11 October 2013 [Government Gazette No. 36928]. The Revised Codes will replace the Black Economic

Empowerment Codes of Good Practice issued on 9 February 2007. The Revised Codes provide for a one year transitional period starting 11 October 2013. During the transitional period, companies may elect to be measured in terms of the Revised Codes or the 2007 version of the Codes. After the first year of the implementation of the Revised Codes, B-BBEE compliance will be measured in terms of the Revised Codes without any discretion. Companies which are governed by Sector-specific Codes will be measured in terms of those Sector Codes.

As such, Transnet will accept B-BBEE certificates issued based on the Revised Codes. Transnet will also continue to accept B-BBEE certificates issued in terms of the 2007 version of the Codes provided it was issued before 10 October 2014. Thereafter, Transnet will only accept B-BBEE certificates issued based on the Revised Codes.

**Note: Failure to submit a valid and original B-BBEE certificate or a certified copy thereof at the Closing Date of this RFQ will result in a score of zero being allocated for B-BBEE.**

*[Refer candidates below for Returnable Documents required]*

### 3 Communication

Respondents are warned that a response will be liable for disqualification should any attempt be made by a Respondent either directly or indirectly to canvass any officer(s) or employee of Transnet in respect of this RFQ between the closing date and the date of the award of the business.

A Respondent may, however, before the closing date and time, direct any written enquiries relating to the RFQ to the following Transnet employee:

Name: Jeff Niemand  
 Email: [jeff.niemand@transnet.net](mailto:jeff.niemand@transnet.net)

Telephone 083 455 6385

Respondents may also, at any time before or after the closing date of the RFQ, communicate with the following Transnet Employee on any administrative matters relating to this RFQ response:

Telephone 021 940 1840 Email: [thabisile.ndlovu@transnet.net](mailto:thabisile.ndlovu@transnet.net)

### 4 Tax Clearance

The Respondent's original and valid Tax Clearance Certificate must accompany the Quotation. Note that no business shall be awarded to any Respondent whose tax matters have not been declared by SARS to be in order.

### 5 VAT Registration

The valid VAT registration number must be stated here: \_\_\_\_\_ *[if applicable].*

### 6 Legal Compliance

The successful Respondent shall be in full and complete compliance with any and all applicable national and local laws and regulations.

### 7 Changes to Quotations

Changes by the Respondent to its submission will not be considered after the closing date and time.

Respondent's Signature

Date & Company Stamp

**8 Pricing**

All prices must be quoted in South African Rand on a fixed price basis, excluding VAT.

**9 Prices Subject to Confirmation**

Prices quoted which are subject to confirmation will not be considered.

**10 Negotiations**

Transnet reserves the right to undertake post-tender negotiations with selected Respondents or any number of shortlisted Respondents.

**11 Binding Offer**

Any Quotation furnished pursuant to this Request shall be deemed to be an offer. Any exceptions to this statement must be clearly and specifically indicated.

**12 Disclaimers**

Transnet is not committed to any course of action as a result of its issuance of this RFQ and/or its receipt of a Quotation in response to it. Please note that Transnet reserves the right to:

- modify the RFQ's goods / services) and request Respondents to re-bid on any changes;
- reject any Quotation which does not conform to instructions and specifications which are detailed herein;
- disqualify Quotations submitted after the stated submission deadline;
- not necessarily accept the lowest priced Quotation;
- reject all Quotations, if it so decides;
- place an order in connection with this Quotation at any time after the RFQ's closing date;
- award only a portion of the proposed goods / services which are reflected in the scope of this RFQ;
- split the award of the order/s between more than one Supplier / Service Provider; or
- make no award at all.

Transnet reserves the right to award business to the highest scoring bidder's unless objective criteria justify the award to another bidder.

**13 Transnet's supplier integrity pact**

Transnet's Integrity Pact requires a commitment from suppliers and Transnet that they will not engage in any corrupt and fraudulent practices, anti-competitive practices; and act in bad faith towards each other. The Integrity Pact also serves to communicate Transnet's Gift Policy as well as the remedies available to Transnet where a Respondent contravenes any provision of the Integrity Pact.

Respondents are required to familiarise themselves with the contents of the Integrity Pact which is available on the Transnet Internet site [[www.transnet.net/Tenders/Pages/default.aspx](http://www.transnet.net/Tenders/Pages/default.aspx)] or on request. Furthermore, Respondents are required to certify that they have acquainted themselves with all the documentation comprising the Transnet Integrity Pact and that they fully comply with all the terms and conditions stipulated in the Transnet Supplier Integrity Pact as follows:

\_\_\_\_\_  
Respondent's Signature

\_\_\_\_\_  
Date & Company Stamp

YES	NO
-----	----

Should a Respondent need to declare previous transgressions or a serious breach of law in the preceding 5 years as required by Annexure A to the Integrity Pact, such declaration must accompany the Respondent's bid submission.

**14 Evaluation Criteria**

Transnet will utilise the following criteria [not necessarily in this order] in choosing a Supplier/Service Provider, if so required:

Criterion	Explanation
<b>Administrative responsiveness</b>	Completeness of response and returnable documents
<b>Substantive responsiveness</b>	Pre-qualification criteria, if any, must be met and whether the Bid materially complies with the specification given.
<b>Final weighted evaluation based on 90/10 preference point system as indicated in paragraph 2</b>	<ul style="list-style-type: none"> <li>• Pricing and service basis [firm] - whilst not the sole factor for consideration, competitive pricing and overall level of unconditional discounts<sup>1</sup> will be critical</li> <li>• B-BBEE status of company - Preference points will be awarded to a bidder for attaining the B-BBEE status level of contribution in accordance with the table indicated below.</li> </ul>

Preference points will be awarded to a bidder for attaining the B-BBEE status level of contribution in accordance with the table below:

B-BBEE Status Level of Contributor	Number of points (90/10 system)
1	10
2	9
3	8
4	5
5	4
6	3
7	2
8	1
Non-compliant contributor	0

<sup>1</sup> Only unconditional discounts will be taken into account during evaluation. A discount which has been offered conditionally will, despite not being taken into account for evaluation purposes, be implemented when payment is effected.

\_\_\_\_\_  
Respondent's Signature

\_\_\_\_\_  
Date & Company Stamp

**15 Validity Period**

Transnet desires a validity period of 30 [thirty] days from the closing date of this RFQ.  
This RFQ is valid until \_\_\_\_\_.

**16 Banking Details**

BANK: \_\_\_\_\_  
BRANCH NAME / CODE: \_\_\_\_\_  
ACCOUNT HOLDER: \_\_\_\_\_  
ACCOUNT NUMBER: \_\_\_\_\_

**17 Company Registration**

Registration number of company / C.C. \_\_\_\_\_  
Registered name of company / C.C. \_\_\_\_\_

**18 Disclosure of Prices Quoted**

Respondents must indicate here whether Transnet may disclose their quoted prices and conditions to other Respondents:

YES  NO

**19 Returnable Documents**

**Returnable Documents** means all the documents, Sections and Annexures, as listed in the tables below.

- a) Respondents are required to submit with their Quotations the **mandatory Returnable Documents**, as detailed below.

***Failure to provide all these Returnable Documents at the Closing Date and time of this RFQ will result in a Respondent's disqualification. Respondents are therefore urged to ensure that all these Documents are returned with their Quotations***

All Sections, as indicated in the footer of each page, must be signed, stamped and dated by the Respondent. Please confirm submission of these mandatory Returnable Documents by \_\_\_\_\_ indicating [Yes or No] in the table below:

Mandatory Returnable Documents		Submitted [Yes or No]
SECTION 2 : Quotation Form (Delivery lead time must be inserted)		

- b) In addition to the requirements of section (a) above, Respondents are further required to submit with their Quotations the following **essential Returnable Documents** as detailed below.

***Failure to provide all these Returnable Documents may result in a Respondent's disqualification. Respondents are therefore urged to ensure that all these documents are returned with their Quotations.***

\_\_\_\_\_  
Respondent's Signature

\_\_\_\_\_  
Date & Company Stamp



All Sections, as indicated in the footer of each page, must be signed, stamped and dated by the Respondent. Please confirm submission of these essential Returnable Documents by so indicating [Yes or No] in the table below:

Essential Returnable Documents	Submitted [Yes or No]
SECTION 1 : Notice to Bidders	
- Valid and original B-BBEE Verification Certificate or certified copy thereof [Large Enterprises and QSEs] Note: failure to provide a valid B-BBEE Verification Certificate at the closing date and time of the RFQ will result in an automatic score of zero for preference	
- Valid and original B-BBEE certificate/sworn affidavit or certified copy thereof from auditor, accounting officer or SANAS accredited Verification Agency [EMEs] Note: failure to provide a valid B-BBEE Verification Certificate at the closing date and time of the RFQ will result in an automatic score of zero being allocated for preference	
- In the case of Joint Ventures, a copy of the Joint Venture Agreement or written confirmation of an intention to enter into a Joint Venture Agreement	
- Original valid Tax Clearance Certificate [Consortia / Joint Ventures must submit a separate Tax Clearance Certificate for each party]	
- SECTION 3 : Standard Terms and Conditions of Contract for the Supply of Goods or Services to Transnet	
SECTION 4 : Vendor Application Form	
- Original cancelled cheque or bank verification of banking details	
- Certified copies of IDs of shareholder/directors/representatives [if applicable]	
- Certified copies of the relevant company registration documents from Companies and Intellectual Property Commission (CIPC)	
- Certified copies of the company's shareholding/director's portfolio	
- Entity's letterhead	
- Certified copy of VAT Registration Certificate [RSA entities only]	
- Certified copy of valid Company Registration Certificate [if applicable]	
- A signed letter from Respondent's auditor or accountant confirming most recent annual turnover figures	
- Financial Statements signed by your Accounting Officer or Audited Financial Statements for previous 3 years	

PRELIMINARY COPY ONLY

Respondent's Signature

Date & Company Stamp



## Section 2 QUOTATION FORM

I/We \_\_\_\_\_ hereby offer to supply the goods/services at the prices quoted in the Price Schedule below, in accordance with the conditions related thereto.

- I/We agree to be bound by those terms and conditions in:
- the Standard Terms and Conditions for the Supply of Goods or Services to Transnet [Section 3 hereof]; and
  - any other standard or special conditions mentioned and/or embodied in this Request for Quotation.

I/We accept that, unless Transnet should otherwise decide and so inform me/us, this Quotation [and, if any, its governing letter and any subsequent exchange of correspondence], together with Transnet's acceptance thereof, shall constitute a binding contract between Transnet and me/us.

I/We further agree that if, after I/we have been notified of the acceptance of my/our Quotation, I/we fail to deliver the said goods/services within the delivery lead-time quoted, Transnet may, without prejudice to any other legal remedy which it may have, cancel the order and recover from me/us any expenses incurred by Transnet in calling for quotations afresh and/or having to accept any less favourable offer.

### Price Schedule

I/We quote as follows for the Supply and Delivery of Track Switch Equipment, at Bellville Square Stores, Cape Town on an "as and when" required basis, price excluding VAT:

Item No	Description of Goods /Services	Quantity	Unit Measure	Unit Price (ZAR)	Total Price (ZAR)
1.	Clamp 160/160mm Aluminium Bimetallic 160/160mm Parallel Clamp (TNB-55)	650	Each		
2.	Feeder Clamp 107/160mm (TNB -80)	450	Each		
3.	Parallel Clamp 160/160mm (TNB-55) Cu-ni-si	650	Each		
4.	Sign "Closed-Open" Indication Section Switch (TWN-5)	102	Each		
5.	Section Insulator Number Board (TNC-14)	102	Each		
6.	Standoff Insulator 25KV Clevis +Tongue Silicon (TNC-14)	51	Each		
7.	Adaptor Plate Copper Tinned (TLC-51)	51	Each		
8.	Clevis and Pipe End Insulator 25KV Silicon (BBB430)	500	Each		

\_\_\_\_\_  
Respondent's Signature

\_\_\_\_\_  
Date & Company Stamp

**Delivery Lead-Time from date of purchase order:** \_\_\_\_\_ **[days/weeks]**

**Notes to Pricing:**

- a) All Prices must be quoted in South African Rand, exclusive of VAT
- b) To facilitate like-for-like comparison bidders must submit pricing strictly in accordance with this price schedule and not utilise a different format. Deviation from this pricing schedule could result in a bid being disqualified. **Refer to the Drawings attached.**
- c) Please note that should you have offered a discounted price(s), Transnet will only consider such price discount(s) in the final evaluation stage if offered on an unconditional basis.

**"PREVIEW COPY ONLY"**

\_\_\_\_\_  
Respondent's Signature

\_\_\_\_\_  
Date & Company Stamp

### Section 3

#### STANDARD TERMS AND CONDITIONS FOR THE SUPPLY OF GOODS OR SERVICES TO TRANSNET

**A Supplier/Service Provider shall be obliged to adhere to the Standard Terms and Conditions for the Supply of Goods and Services to Transnet as expressed hereunder. Should the Respondent find any condition(s) unacceptable, it should indicate which condition(s) is/are unacceptable and offer an alternative(s). A Quotation submitted by a Respondent will be subjected to review and acceptance or rejection of its proposed contractual terms and conditions by Transnet's Legal Counsel, prior to consideration for an award of business.**

#### 1 SOLE AGREEMENT

Unless otherwise agreed in writing, these terms [Terms and each Term] and Transnet's purchase order(s) [Order or Orders] represent the only conditions upon which Transnet SOC Ltd [Transnet] procures goods [the Goods] or services [the Services] specified in the Order from the person to whom the Order is addressed [the Supplier/Service Provider]. Transnet does not accept any other conditions which the Supplier/Service Provider may specify, unless otherwise agreed to by Transnet in writing. In the event of any inconsistency between these terms and any Order, these Terms shall take precedence.

#### 2 CONFORMITY WITH ORDER

Goods/Services shall conform strictly with the Order. The Supplier/Service Provider shall not vary the quantities specified and/or the specifications, if any, stipulated in the Order, without the prior written consent of Transnet. The Supplier/Service Provider warrants that the Goods/Services shall be fit for their purpose and of satisfactory quality.

#### 3 DELIVERY AND TITLE

- 3.1 The delivery dates and addresses are those in the Order. Time shall be of the essence in respect of the Supplier's/Service Provider's obligations under the Order.
- 3.2 The Supplier/Service Provider will not be excused for delay in delivery or performance except due to circumstances outside its control and then only subject to the Supplier/Service Provider having notified Transnet in writing on becoming aware of such circumstances. Transnet may terminate an Order, in whole or in part, without incurring any liability to the Supplier/Service Provider if such a delay becomes, in Transnet's absolute opinion, significant.
- 3.3 Risk of loss or damage to Goods shall pass to Transnet on delivery, and title shall pass to Transnet when payment to the Supplier for the Goods has been effected.
- 3.4 If on delivery, the Goods/Services do not conform to the Order, Transnet may reject the Goods/Services and the Supplier/Service Provider shall promptly rectify any defects or in Transnet's opinion, supply appropriate replacement Goods/Services at the Supplier's/Service Provider's expense within the specified delivery times, without any liability due by Transnet. Goods shall be subject to such testing and/or inspection as Transnet may consider necessary.

Respondent's Signature

Date & Company Stamp

#### 4 PRICE AND PAYMENT

- 4.1 Prices specified in an Order cannot be increased. Payment for the Goods/Services shall be made by Transnet against an original undisputed invoice(s) [a Tax Invoice], supporting documentation and month-end statement from the Supplier/Service Provider. Tax Invoices plus supporting documentation shall be posted to the address shown in the Order.
- 4.2 Payment of the Supplier's/Service Provider's valid Tax Invoice(s) will be made by Transnet in the South African currency and on the terms stated in the Order, the standard payment terms being 30 [thirty] days from date of receipt by Transnet of a month-end statement, unless otherwise agreed to in writing. Transnet shall arrange for payment of such Tax Invoices and any pre-authorised additional expenses incurred, provided that the authorised expenses are supported by acceptable documentary proof of expenditure incurred [where this is available]. Any amounts due in terms of these Terms shall be paid to the Supplier/Service Provider, taking into account any deduction or set-off and bank charges.

#### 5 PROPRIETARY RIGHTS AND LIABILITY

If any allegations should be made or any claim asserted against Transnet that ownership of, or any act or omission by Transnet in relation to Goods/Services or any written material provided to Transnet relating to any Goods/Services or pursuant to an Order being a violation or infringement of any third party's contractual, industrial, commercial or intellectual property rights including but not limited to any patent, registered design, design right, trade mark, copyright or service mark on any application thereof, the Supplier/Service Provider hereby indemnifies Transnet against and hold it harmless from any and all losses, liabilities, costs, claims, damages and expenses [including any legal fees] arising directly or indirectly from such allegation or claim provided that this indemnity shall not apply where the allegation or claim arises solely as a result of the Supplier/Service Provider following a design or process originated and furnished by Transnet. The Supplier/Service Provider shall either

- a) procure for Transnet the right to continue using the infringing Goods; or
  - b) modify or replace the Goods/Services so that they become non-infringing,
- provided that in both cases the Goods/Services shall continue to meet Transnet's requirements and any specifications stipulated in the Order. Should neither option be possible, the Supplier/Service Provider may remove, with Transnet's prior written consent, such Goods/Services and will pay to Transnet a sum equivalent to the purchase price. If Transnet refuses to give such consent, the Supplier/Service Provider shall have no liability in respect of any continued use of the infringing Goods/Services after Supplier's/Service Provider's prior written request to remove the same.

#### 6 PROPRIETARY INFORMATION

All information which Transnet has divulged or may divulge to the Supplier/Service Provider and any information relating to Transnet's business which may have come into the Supplier's/Service Provider's possession whilst carrying out an Order, and the existence of the Order, shall be treated by the Supplier/Service Provider as confidential information and shall not, without Transnet's prior written consent, be disclosed to any third party, or be used or copied for any purposes other than to perform the Order. This clause does not apply to information which is public knowledge or available from other sources other than by breach of this Term. Upon request by Transnet, the Supplier/Service Provider shall return all

---

Respondent's Signature

---

Date & Company Stamp

materials issued pursuant to the Order and, pending this, shall protect Transnet's rights in any such materials. Such confidential information shall at all material times be the property of Transnet.

## 7 DEVELOPMENT WORK IN THE PRODUCTION OF GOODS

If the production or provision of any Goods involves research and/or development which are wholly or partly funded by Transnet, then all intellectual property or other rights as a result thereof shall be the property of Transnet on creation.

## 8 PUBLICITY

The Supplier/Service Provider shall not name Transnet or use its trademarks, service marks [whether registered or not] or Goods in connection with any publicity without Transnet's prior written consent.

## 9 AFTER SALES SERVICE

The Supplier/Service Provider shall provide replacement parts necessary to ensure the uninterrupted operation of the Goods supplied for the duration of the warranty period, from delivery of any particular item of the Goods and if requested by Transnet shall make these parts available to a third party maintainer of Transnet's choice at the same price as if the parts had been supplied to Transnet. The Supplier undertakes to provide a maintenance service for Goods, should Transnet so request, on terms to be agreed. If the Order so indicates, the Supplier will provide a warranty service for the Goods at a level to be agreed with Transnet.

## 10 TERMINATION OF ORDER

10.1 Transnet may cancel an Order in whole or in part at any time upon at least 7 [seven] days' written notice to the Supplier/Service Provider or when there is a change in control of the Supplier/Service Provider or the Supplier/Service Provider commits any serious breach or any repeated or continued material breach of its obligations under these Terms and/or Order or shall have been guilty of conduct tending to bring its name into disrepute, on written notice to the Supplier/Service Provider when such work on the Order shall stop.

10.2 Transnet shall pay the Supplier/Service Provider a fair and reasonable price for justified work in progress, where such price reflects only those costs not otherwise recoverable by the Supplier/Service Provider, at the time of termination, and the Supplier/Service Provider shall give Transnet full assistance to check the extent of such work in progress. Payment of such price shall be in full and final satisfaction of any claims arising out of such termination and upon such payment the Supplier/Service Provider shall deliver to Transnet all work, including any materials, completed or in progress. The sum payable to the Supplier/Service Provider under this clause will not in any event exceed the total amount that would have been payable to the Supplier/Service Provider had the Order not been terminated.

10.3 In the event of termination the Supplier/Service Provider must submit all claims within 2 [two] months of termination after which time claims will only be met in what Transnet considers exceptional circumstances.

10.4 If the Goods or Services are not provided in accordance with an Order, the Order shall be deemed terminated and the Supplier/Service Provider shall compensate Transnet for any costs incurred in obtaining substitute Goods or any damage caused due to the failure or delay in the delivery.

\_\_\_\_\_  
Respondent's Signature

\_\_\_\_\_  
Date & Company Stamp



**11 ACCESS**

The Supplier/Service Provider shall be liable for the acts, omissions and defaults of its personnel or agents who, for the purposes of the Order, shall be treated as if they are the Supplier's/Service Provider's employees. The Supplier/Service Provider shall ensure that any such personnel or agents, whilst on Transnet's premises, shall comply with Transnet's health and safety, security and system security rules and procedures as and where required.

**12 WARRANTY**

The Supplier/Service Provider warrants that it is competent to supply the Goods/Services in accordance with these Terms to the reasonable satisfaction of Transnet and that all Goods/Services delivered under the Order: (a) conform and comply in all relevant legislation, standards, directives and orders related to [inter alia] the supply, manufacture and use of the Goods/Services in force at the time of delivery, and to any specifications referred to in the Order; (b) will not cause any deterioration in the functionality of any Transnet equipment; and (c) do not infringe any third party rights of any kind. The Supplier/Service Provider hereby indemnifies Transnet against all losses, liabilities, costs, claims, damages, expenses and awards of any kinds incurred or made against Transnet in connection with any breach of this warranty.

**13 INSOLVENCY**

If the Supplier/Service Provider should have a receiver, manager, administrator, liquidator or like person appointed over all or any part of its assets or if the Supplier/Service Provider compounds with its creditors or passes a resolution for the winding up or administration of the Supplier/Service Provider, Transnet is at liberty to terminate the Order or Orders forthwith. At its option, to seek performance by any such appointed person.

**14 ASSIGNMENT**

The Supplier/Service Provider shall not assign its obligations under an Order without Transnet's prior written consent, which consent shall not be unreasonably withheld or delayed.

**15 NOTICES**

Notices under these Terms shall be delivered by hand to the relevant address of the parties in the Order or may be served by facsimile or by email, in which event notice shall be deemed served on acknowledgement of receipt by the recipient.

**16 LAW**

Orders shall be governed by and interpreted in accordance with South African law and any disputes arising herein shall be subject to South African arbitration under the rules of the Arbitration Foundation of South Africa, which rules are deemed incorporated by reference in this clause. The reference to arbitration shall not prevent Transnet referring the matter to any South African courts, having jurisdiction, to which the Supplier/Service Provider hereby irrevocably submits but without prejudice to Transnet's right to take proceedings against the Supplier/Service Provider in other jurisdictions and/or obtaining interim relief on an urgent basis from a court of competent jurisdiction pending the decision in other courts or from instituting in any court of competent jurisdiction any proceedings for an interdict or any other injunctive relief. If the Supplier/Service Provider does not have a registered office in the South Africa it will at all times maintain

---

Respondent's Signature

---

Date & Company Stamp

an agent for service of process in South Africa and shall give Transnet the name and address of such agent as such may be amended, in writing, from time to time.

#### **17 GENERAL**

Completion or termination of an Order shall be without prejudice to any Term herein which by its nature would be deemed to continue after completion or termination. Headings are included herein for convenience only. If any Term herein be held illegal or unenforceable, the validity or enforceability of the remaining Terms shall not be affected. No failure or delay by Transnet to enforce any rights under these Terms will operate as a waiver thereof by Transnet. All rights and remedies available to either party under these Terms shall be in addition to, not to the exclusion of, rights otherwise available at law.

#### **18 COUNTERPARTS**

These Terms and conditions may be signed in any number of counterparts, all of which taken together shall constitute one and the same instrument. Any party may enter into this agreement by signing any such counterpart.

**PREVIEW COPY ONLY**

---

Respondent's Signature

---

Date & Company Stamp



By signing this RFQ document, the Respondent is deemed to acknowledge that he/she has made himself/herself thoroughly familiar with all the conditions governing this RFQ, including those contained in any printed form stated to form part hereof and Transnet SOC Ltd will recognise no claim for relief based on an allegation that the Respondent overlooked any such condition or failed to properly take it into account for the purpose of calculating quoted prices or otherwise.

SIGNED at \_\_\_\_\_ on this \_\_\_\_\_ day of \_\_\_\_\_ 2014

.....  
SIGNATURE OF RESPONDENT'S AUTHORISED REPRESENTATIVE  
NAME: \_\_\_\_\_  
DESIGNATION: \_\_\_\_\_  
REGISTERED NAME OF COMPANY: \_\_\_\_\_  
PHYSICAL ADDRESS: \_\_\_\_\_  
\_\_\_\_\_  
\_\_\_\_\_

**Respondent's contact person:** *[Please complete]*

Name :	_____
Designation :	_____
Telephone :	_____
Cell Phone :	_____
Facsimile :	_____
Email :	_____
Website :	_____

**Transnet urges its clients, suppliers and the general public to report any fraud or corruption to  
TIP-OFFS ANONYMOUS : 0800 003 056**

\_\_\_\_\_  
Respondent's Signature  
\_\_\_\_\_  
Date & Company Stamp

## Section 4 VENDOR APPLICATION FORM

*Respondents are to furnish the following documentation and complete the Vendor Application Form below:*

1. **Original** cancelled cheque **OR** letter from the Respondent's bank verifying banking details [with bank stamp]
2. **Certified** copy of Identity Document(s) of Shareholders/Directors/Members [where applicable]
3. **Certified** copies of the relevant company registration documents from Companies and Intellectual Property Commission (CIPC)
4. **Certified** copies of the company's shareholding/director's portfolio
5. A letter on the company's letterhead confirm physical and postal addresses
6. **Original** valid SARS Tax Clearance Certificate
7. **Certified** copy of VAT Registration Certificate
8. **A valid and original** B-BBEE Verification Certificate / sworn affidavit **or certified copy** thereof meeting the requirements for B-BBEE compliance as per the B-BBEE Codes of Good Practice
9. **Certified** copy of valid Company Registration Certificate [if applicable]

### Vendor Application Form

Company trading name			
Company registered name			
Company Registration Number or ID Number if a Sole Proprietor			
Form of entity [✓] CC	Trust	Pty Ltd	Limited Partnership
VAT number [if registered]			
Company telephone number			
Company fax number			
Company email address			
Company website address			
Bank name			Branch & Branch code
Account holder			Bank account number
Postal address			

Respondent's Signature

Date & Company Stamp



10001015

DRG NO CEE-  
TNB-58  
SHT - OF -



STORES ITEM NO.  
54/4081  
DIMENSIONS: mm  
SCALE: 1:1

AMENDMENTS

NO	NAME	DATE
1	L E WOOD	96-08-01

REDRAWN DRG NO  
WAS CEE-TN-364.  
DO REF: 196/009

INFRASTRUCTURE (ELECTRICAL)  
SPOORNET  
ENG: \_\_\_\_\_  
TC BROOK  
DRN-A ZAZWORKA CKD: S MOUTON DATE: 14-05-08  
DO REF: Y74/34 GEN TOL: LINF  
MATERIAL: ITEM NO \_\_\_\_\_, COPPER TO SPEC. BS.1977

# TERMINAL, LUG

CABLE SIZE 160mm<sup>2</sup>

- 1. HOLE: AFTER PUNCHING OR DRILLING, BURRS TO BE REMOVED.
- 2. LUG: TO BE COMPLETELY TINNED, SEALING THE EDGES MARKED "SEAL" TO SPEC. BS.1872S.12C.
- 3. SPADE SURFACES TO BE FLAT.
- 4. LUG WILL BE CRIMPED INTO HEXAGONAL CONFIGURATION BY MEANS OF HYDRAULIC COMPRESSION TOOL (DRG NO CEE-PP-15)
- 5. INSPECTION HOLE NOT TO BE PROVIDED.
- 6. THIS DRAWING IS FOR TENDER PURPOSES ONLY.
- 7. DIMENSIONS NOT INDICATED TO BE DECIDED BY TENDERER.

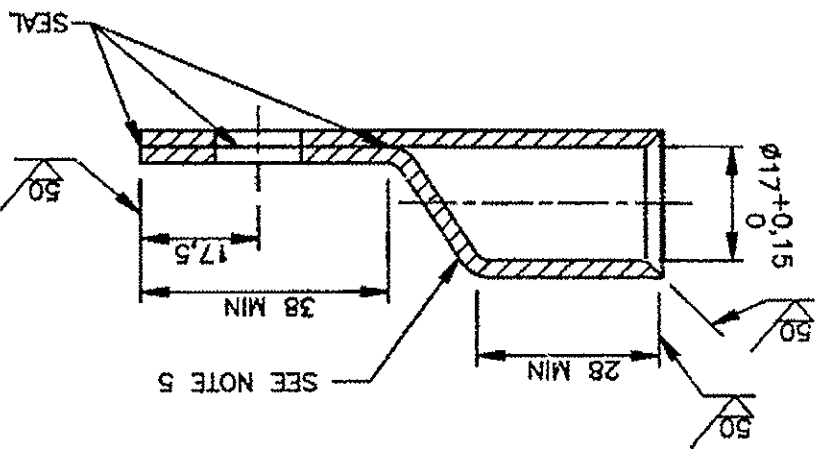
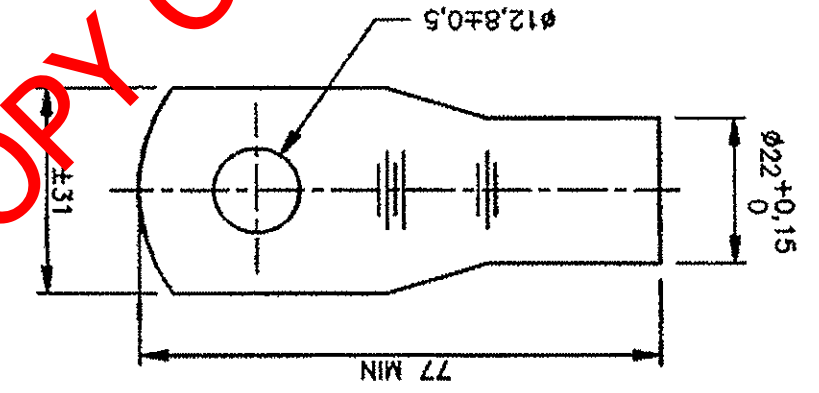

**PREVIEW COPY**



ITEM	DESCRIPTION	QTY	STORES ITEM NO	DRG NO CEE-	AMENDMENTS
1	CONDUCTOR SPICE, PARALLEL HALF CLAMP	2	TNB-54		
2	SCREW, MACHINE, CU-NI-SI, HEX. HEAD, M12x6g-35Lg. (SPEC. CEE.0063)	2	54/3670		
3	WASHER, LOCK, PHOSPHOR BRONZE, INTERNALLY TOOTHED, M12 (SPEC. BS.407)	2	54/2704		
4	CONDUCTOR SPICE LINER, 162mm <sup>2</sup> ACSR CATENARY WIRE (SEE NOTE)	2	54/2704		
ITEM 3 ALTERNATIVE MATERIAL: STAINLESS STEEL TO SPEC AISI GRADE 304					
STORES ITEM NO					
54/786	100mm <sup>2</sup> /80mm <sup>2</sup> - 50mm <sup>2</sup>	2	TNB-90		
54/791	100mm <sup>2</sup> /80mm <sup>2</sup> - 100mm <sup>2</sup> /80mm <sup>2</sup>	2			
54/2728	160mm <sup>2</sup> - 50mm <sup>2</sup>	2			
54/2753	160mm <sup>2</sup> - 100mm <sup>2</sup> /80mm <sup>2</sup>	2			
54/2777	160mm <sup>2</sup> - 160mm <sup>2</sup>	2			
54/843	250mm <sup>2</sup> - 50mm <sup>2</sup>	2			
54/867	250mm <sup>2</sup> - 100mm <sup>2</sup> /80mm <sup>2</sup>	2			
54/880	250mm <sup>2</sup> - 160mm <sup>2</sup>	2			
54/907	250mm <sup>2</sup> - 250mm <sup>2</sup>	2			

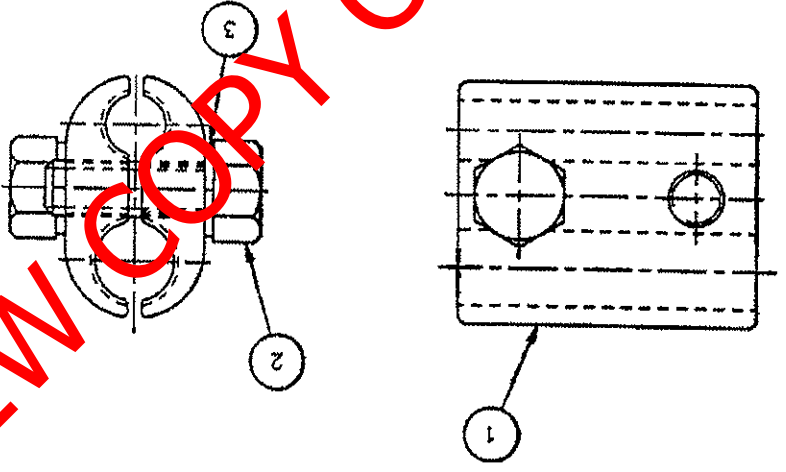

NOTE  
 USE ITEM 4 ON THE 250mm<sup>2</sup> ACSR (TIGER) CATENARY  
 IS USED FOR THE 162mm<sup>2</sup> ACSR

DO REF: M119/70	GEN TOL: LINF	ANG
DRN: E LOUW	CKD: G W MALONE	DATE: 20-11-19
ENG: F PIENAAR	T C BROOKS	FOR CHIEF ENG
INFRASTRUCTURE (ELECTRICAL)		
SPOORNET		

# CONDUCTOR SPICE

PARALLEL CLAMP

DIMENSIONS: mm	SCALE: 1:1
DRAWING NO CEE- TNB-55	
SHEET OF	

Handwritten initials: *SC*

PREVIEW COPY

INFRASTRUCTURE (ELECTRICAL)  
SPOORNET

ENG: XXX  
DRN: B STEWART  
DO REF: 179/88  
CXC: S MOUTON  
GEN TOL: LINF 0,5  
DATE: 0-01-30  
CHIEF ENG

CLAMP, ELECTRICAL  
FEEDER HALF CLAMP, 107mm<sup>2</sup> CONTACT WIRE.

SHEET 05 OF 05  
DRAWING NO CEE-TNB-80  
A3

MATERIAL: CU-NI-SI ALLOY SPEC CEE. 0063 OR ALTERNATIVELY DEZINCIFICATION RESISTANT BRASS (DZR BRASS), GR C2132 TO BS 2874.

- NOTES
1. THESE SURFACES TO BE SERRATED. PITCH: 1 x 0,3.
  2. TOLERANCE ON RADII A & B: -0,5.
  3. ALL UNSPECIFIED RADII R2.
  4. FOR CU-NI-SI ALLOY TO BE READ IN CONJUNCTION WITH SPEC. CEE.0063.
  5. FOR DEZINCIFICATION RESISTANT BRASS (DZR BRASS).
  6. GR C2132 TO BE READ IN CONJUNCTION WITH BS 2874.
  6. FOR ASSEMBLY SEE DRG NO. CEE-TNB-81.

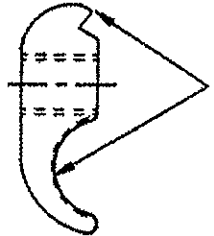
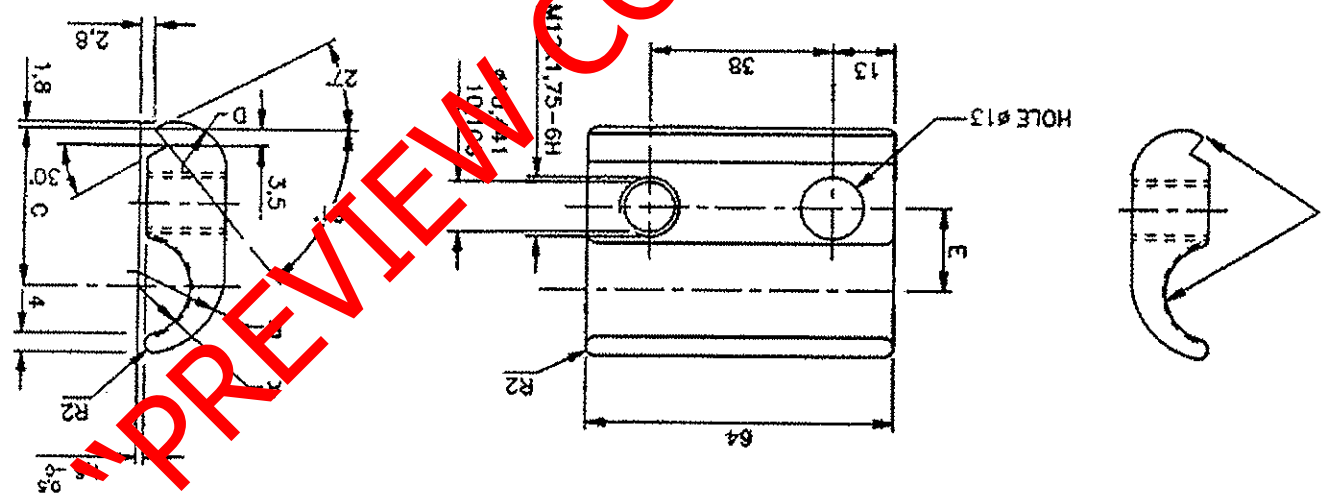

STORES ITEM NO	CONDUCTOR SIZES					DIMENSIONS		AMENDMENTS
	A	B	C	D	E	NO	NAME	
S4/6815	4,5	15	27,5	6,5	11,5	1	BOCKMUND	97-08-04
S4/10751	6,5	15	28,5	6,5	13,5			
S4/10726	8,5	15	31,5	6,5	15,5			
S4/10738	10,5	18	33,5	9,5	18			

DRG. MATERIAL AND NOTES REVISÉ. DRG NO WAS CEE-TN-182  
DO REF: 197/020

10000002

DRAWING NO CEE-  
TWN-5  
SHEET - OF -



STORES ITEM NO  
54/3228  
DIMENSIONS: mm  
SCALE: 1:5

AMENDMENTS  
NO NAME DATE  
14 H V V 93-11-08  
RADIUS R6 REMOVED.  
DO REF: 193/052  
15 J HARCUS 94-10-31  
NOTE RE SABS 1186  
ADDED.  
DO REF: 194/028

# INDICATING PLATE

"CLOSED - OPEN"  
SECTION SWITCHES ONLY

MATERIAL: "CHROMADEK" (SILICONE POLYESTER COATING) OR APPROVED EQUIVALENT, 1mm THICK.		
DO REF: _____	GEN TOL: LINF 0.5	
DRN: L.D.	CKD: W.R.G.	DATE: 94-03-13
ENG: T.C.B.	J. SAMUEL CHIEF ENG	
<b>SPORNET</b> (ELECTRICAL) INFRASTRUCTURE		

- NOTES
1. APPLY, WITHIN CIRCLE, DECAL NUMBERS INDICATING ACTUAL TRACKS CONTROLLED BY RELEVANT SWITCH.
  2. NOT TO BE USED ON ISOLATING AND EARTHING SWITCHES.
  3. WARNING SIGN MUST CONFORM TO SPEC SABS 1186.
- FINISH  
LETTERS TO BE SILK SCREENED ONTO PLATE USING "MIRACLE INK" OR APPROVED EQUIVALENT.
- COLOURS  
LETTERS ..... BLACK  
BACKGROUND ..... WHITE

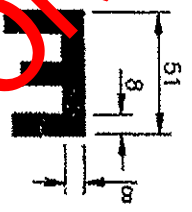
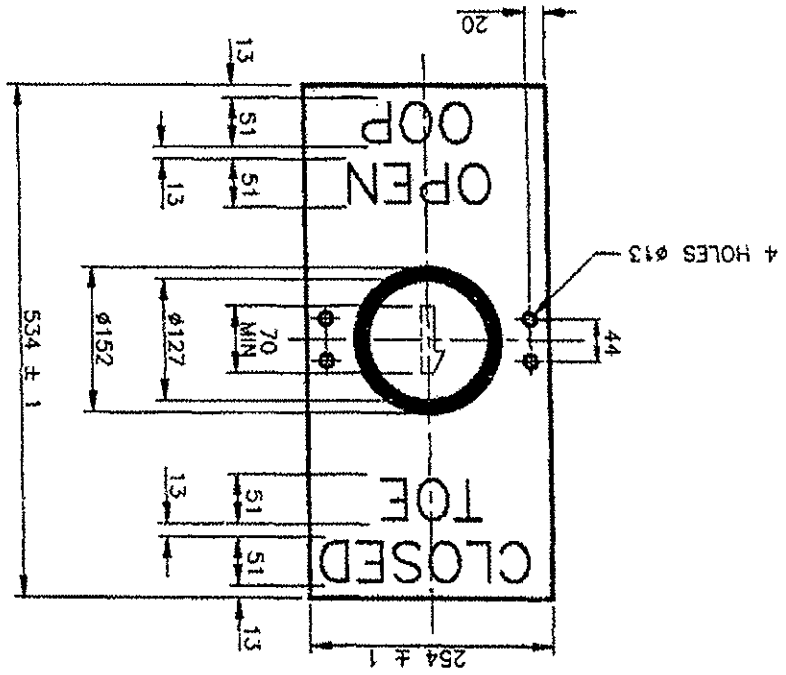

"PREVIEW COPY ONLY"







3A

4

4

3A

DRAWING TITLE: ADAPTOR PLATE, INSULATOR		DRAWING NO: 29-95-45		DATE: 29-95-45		DRAWN BY: G. J. JACKSON		CHECKED BY: G. J. JACKSON	
MATERIAL: COPPER PLATE, 100 x 10 THK. SPEC. BS.4628		SCALE: 1:2		DIMENSIONS: mm		STORAGE ITEM NO.		STOCK NO.	
DRAWING NO: TLC-51		REV: 01		DATE: 29-95-45		DRAWN BY: G. J. JACKSON		CHECKED BY: G. J. JACKSON	
DRAWING TITLE: ADAPTOR PLATE, INSULATOR		DRAWING NO: 29-95-45		DATE: 29-95-45		DRAWN BY: G. J. JACKSON		CHECKED BY: G. J. JACKSON	
MATERIAL: COPPER PLATE, 100 x 10 THK. SPEC. BS.4628		SCALE: 1:2		DIMENSIONS: mm		STORAGE ITEM NO.		STOCK NO.	
DRAWING NO: TLC-51		REV: 01		DATE: 29-95-45		DRAWN BY: G. J. JACKSON		CHECKED BY: G. J. JACKSON	

NOTE: IN BOTH FACES.

5 HOLES Ø18

HOLE #18

(100)

(100)

REV	DATE	BY
01	29-95-45	G. J. JACKSON

REVISIONS

1. L. E. WOODHEAD

2. G. J. JACKSON

3. G. J. JACKSON

4. G. J. JACKSON

5. G. J. JACKSON

6. G. J. JACKSON

7. G. J. JACKSON

8. G. J. JACKSON

9. G. J. JACKSON

10. G. J. JACKSON

11. G. J. JACKSON

12. G. J. JACKSON

13. G. J. JACKSON

14. G. J. JACKSON

15. G. J. JACKSON

16. G. J. JACKSON

17. G. J. JACKSON

18. G. J. JACKSON

19. G. J. JACKSON

20. G. J. JACKSON

21. G. J. JACKSON

22. G. J. JACKSON

23. G. J. JACKSON

24. G. J. JACKSON

25. G. J. JACKSON

26. G. J. JACKSON

27. G. J. JACKSON

28. G. J. JACKSON

29. G. J. JACKSON

30. G. J. JACKSON

31. G. J. JACKSON

32. G. J. JACKSON

33. G. J. JACKSON

34. G. J. JACKSON

35. G. J. JACKSON

36. G. J. JACKSON

37. G. J. JACKSON

38. G. J. JACKSON

39. G. J. JACKSON

40. G. J. JACKSON

41. G. J. JACKSON

42. G. J. JACKSON

43. G. J. JACKSON

44. G. J. JACKSON

45. G. J. JACKSON

46. G. J. JACKSON

47. G. J. JACKSON

48. G. J. JACKSON

49. G. J. JACKSON

50. G. J. JACKSON

51. G. J. JACKSON

52. G. J. JACKSON

53. G. J. JACKSON

54. G. J. JACKSON

55. G. J. JACKSON

56. G. J. JACKSON

57. G. J. JACKSON

58. G. J. JACKSON

59. G. J. JACKSON

60. G. J. JACKSON

61. G. J. JACKSON

62. G. J. JACKSON

63. G. J. JACKSON

64. G. J. JACKSON

65. G. J. JACKSON

66. G. J. JACKSON

67. G. J. JACKSON

68. G. J. JACKSON

69. G. J. JACKSON

70. G. J. JACKSON

71. G. J. JACKSON

72. G. J. JACKSON

73. G. J. JACKSON

74. G. J. JACKSON

75. G. J. JACKSON

76. G. J. JACKSON

77. G. J. JACKSON

78. G. J. JACKSON

79. G. J. JACKSON

80. G. J. JACKSON

81. G. J. JACKSON

82. G. J. JACKSON

83. G. J. JACKSON

84. G. J. JACKSON

85. G. J. JACKSON

86. G. J. JACKSON

87. G. J. JACKSON

88. G. J. JACKSON

89. G. J. JACKSON

90. G. J. JACKSON

91. G. J. JACKSON

92. G. J. JACKSON

93. G. J. JACKSON

94. G. J. JACKSON

95. G. J. JACKSON

96. G. J. JACKSON

97. G. J. JACKSON

98. G. J. JACKSON

99. G. J. JACKSON

100. G. J. JACKSON

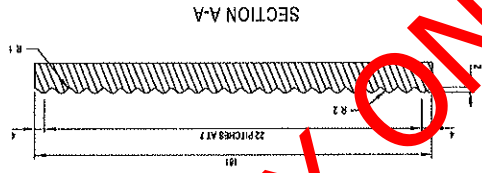
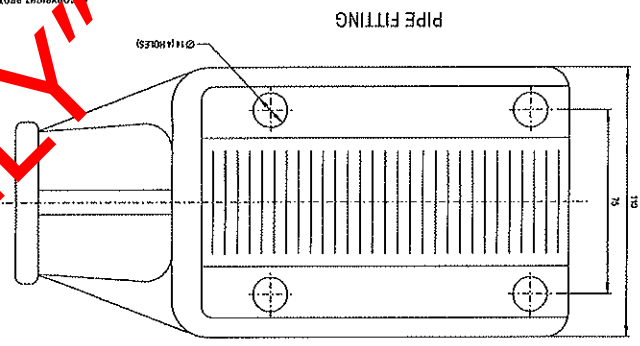

NOTES  
1. Material and thermal dimensions of cap top and resistor requirements and draw in the manufacturer.  
2. The following dimensions in millimeters must appear on these details.  
A) Terminal  
B) Insulator thickness  
C) Bush diameter  
3. Finish for all drawings to Spec. SANS 121  
4. For use with composite compression insulators. See Dwg no BB0429 & BB0559

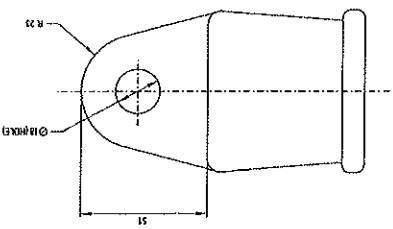
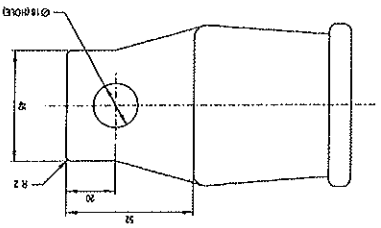
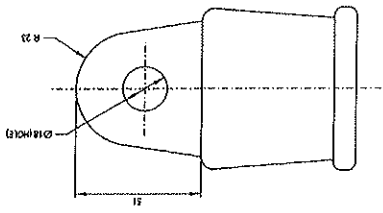
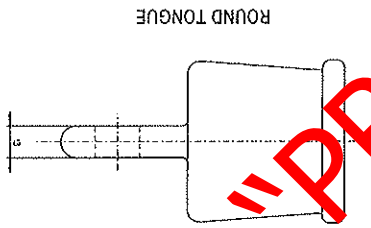
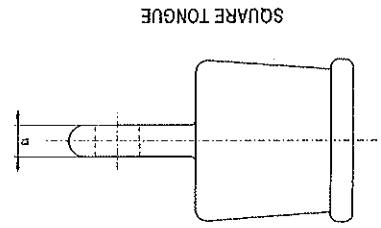
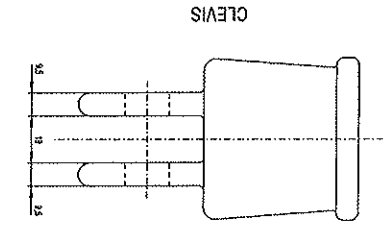
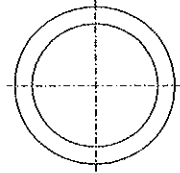
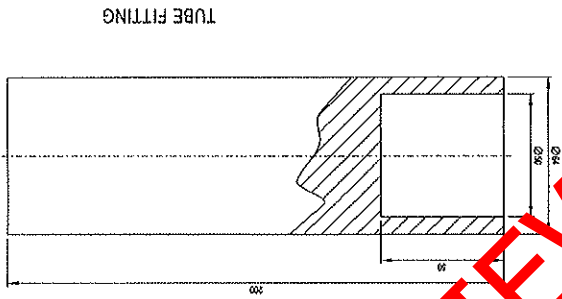
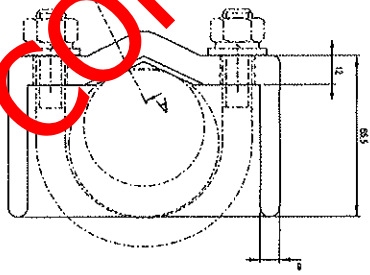
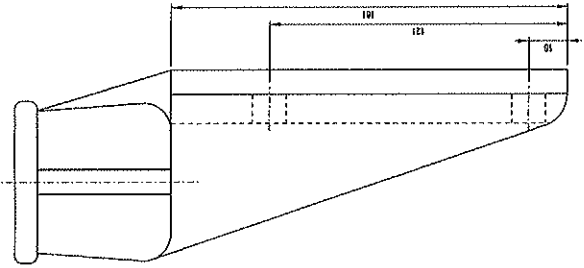

"PREVIEW COPY ONLY"