



TRANSNET FREIGHT RAIL, a division of **TRANSNET SOC LTD**

Registration Number 1990/000900/30[hereinafter referred to as **Transnet**]

REQUEST FOR QUOTATION [RFQ] No SCS D 496 CRAC DNR 9786

FOR THE SUPPLY OF: ROOF REPAIRS (ASBESTOS) PIETERMARITZBURG (ONCE OFF.)

DELIVERY TO: PIETERMARITZBURG

ISSUE DATE: 13 FEBRUARY 2013

**SITE MEETING: 27 FEBRUARY 2013 at 10H00
PIETERMARITZBURG.**

CLOSING DATE: 7 MARCH 2013

CLOSING TIME: 10:00

VALIDITY: 3 MAY 2013

**DIRECTIONS TO SITE MEETING CONTACT JOHNNY FORSTER
Tel 031 3615008 CELL 0833036690.**

“PREVIEW COPY ONLY”

Section 1
NOTICE TO BIDDERS

Quotations which must be completed as indicated in Section 2 of this RFQ are to be submitted as follows:

METHOD: COURIER/ HAND DELIVER
CLOSING VENUE: CHAIRMAN TRANSNET FREIGHT RAIL ACQUISITION COUNCIL
GROUND FLOOR INYANDA HOUSE 1
21 WELLINGTON ROAD PARKTOWN
JOHANNESBURG 2001
Tender box.

1 Responses to RFQ

Responses to this RFQ must not include documents or reference relating to any other quotation or proposal. Any additional conditions must be embodied in an accompanying letter.

2 Broad-Based Black Economic Empowerment [B-BBEE]

Transnet fully endorses and supports the Government's Broad-Based Black Economic Empowerment Programme and it would therefore prefer to do business with local business enterprises who share these same values. Transnet will accordingly allow a "preference" to companies who provide a B-BBEE Verification Certificate. All procurement transactions will be evaluated accordingly.

2.1 B-BBEE Scorecard and Rating

As prescribed in terms of the Preferential Procurement Policy Framework Act (PPPFA), Act 5 of 2000 and its Regulations, Respondents are to note the following:

- Proposals will be evaluated on price which will be allocated 80 points and preference which will be allocated 20 points, dependent on the value of the Services
- The 80/20 preference point system applies where the acquisition of the Services will be less than R1 000 000.00.
- If the 80/20 preference point system is stipulated and all Bids received exceed R1 000 000.00, the RFP will be cancelled

In compliance with the Government Gazette No 34612, Notice No. 754 dated 23 September 2011, as from 1 October 2011 valid B-BBEE Verification Certificates must be issued by:

- a) Verification Agencies accredited by the South African National Accreditation System [SANAS]; or
- b) Registered Auditors approved by the Independent Regulatory Board of Auditors [IRBA], in accordance with the approval granted by the Department of Trade and Industry.

Enterprises will be rated by such agencies based on the following:

- c) **Large Enterprises** [i.e. annual turnover greater than R35 million]:
 - Rating level based on all seven elements of the B-BBEE scorecard

- d) **Qualifying Small Enterprises – QSE** [i.e. annual turnover between R5 million and R35 million]:
- Rating based on any four of the elements of the B-BBEE scorecard
- e) **Exempted Micro Enterprises – EME** [i.e. annual turnover less than R5 million]:

In accordance with B-BBEE Codes of Good Practice [Statement 000, Section 4], any enterprise with an annual total revenue of R 5 million or less qualifies as an EME.

- Automatic rating of B-BBEE Level 4 irrespective of race or ownership
- Black ownership greater than 50% or Black Women ownership greater than 50% automatically qualify as B-BBEE Level 3

Sufficient evidence to qualify as an EME would be a certificate (which may be in the form of a letter) from an auditor or accounting officer or a certificate from a Verification Agency accredited by SANAS. The certificate must confirm the company's turnover, black ownership / black female ownership and B-BBEE status level.

Respondents are required to furnish proof of the above to Transnet. [i.e. a detailed scorecard as stipulated above in respect of Large Enterprises and QSEs, or a certificate in respect of EMEs].

Transnet will accordingly allocate a maximum of **20 [twenty] points** in accordance with the **80/20** preference point system prescribed in the Preferential Procurement Policy Framework Act (PPPFA), Act 5 of 2000 and its Regulations to the Respondent's final score based on an entity's B-BBEE scorecard rating. *[Refer **Annexure A** for further details].*

N.B. Failure to submit a B-BBEE certificate, which is valid as at the Closing Date of this RFP, will result in a score of zero being allocated for B-BBEE.

[Refer Section 3, Vendor Application Form for Returnable Documents required]

2.2 Further Recognition Criteria

- a) Further Recognition Criteria (Current)

As a pre-qualification criterion, certain minimum requirements with regard to the Respondent's CURRENT B-BBEE status at the time of submission of their bid must be met. These minimum requirements will be measured based on the extent to which the Respondent's current black ownership, management control and employment equity meets or exceeds certain minimum targets. Please note that a Respondent's ownership, management control and employment equity at the time of the submission of the bid, may differ from that which is reflected in the B-BBEE scorecard. When claiming that the minimum targets for FRC (Current) has been met, the Respondent must reflect his B-BBEE status at the time of submitting the bid. Supporting documentation may be requested in this regard. The minimum requirements for this RFP for FRC (Current) are stipulated in the table below:

PREQUALIFICATION CRITERIA	MINIMUM COMPLIANCE TARGET (%) AS A PERCENTAGE OF THE ORGANISATION
Further Recognition Criteria (Current):	
Black Ownership > 50%	2%
Black Woman Ownership >30%	2%
EME & QSE	1%

N.B. Failure to achieve the minimum prequalification targets allocated for FRC (Current) for any one of the criteria listed above at the closing date of this tender will result in disqualification.

Note: Should a JV be envisaged, the principal Respondent is required to submit the required responses as indicated above.

3 Communication

- a) Respondents are warned that a response will be liable for disqualification should any attempt be made by a Respondent either directly or indirectly to canvass any officer(s) or employee of Transnet in respect of this RFQ between the closing date and the date of the award of the business.
- b) A Respondent may, however, before the closing date and time, direct any written enquiries relating to the RFQ to the following Transnet employee:

Name: J FORSTER (technical) R FRANKISH (ADMIN)
 Email: John.Forster@transnet.net Bobby.Frankish@transnet.net

Quotations are requested from all interested parties to supply the above mentioned requirements to Transnet Freight Rail.

On or after 13 February 2013 R F Q document can be inspected or obtained from Transnet Freight Rail SCS office 100 EEL ROAD BAYHEAD DURBAN.

The site meeting is compulsory and companies not attending will be overlooked in the tender process. Safety Shoes and Reflective Vests must be worn to the site meeting. A non-refundable charge of R150.00 (vat incl) will be levied. Payment to be made to Standard Bank acc no 203158598 branch code 004805 indicating reference no Erac LSE 9929 and your company name. Receipts to be presented on collection of tender document. Note this amount is not refundable.

- c) Respondents may also, at any time after the closing date of the RFQ, communicate with Prudence Nkabinde on any matter relating to its RFQ response:

Telephone 011 5449486 Fax 011 7749760
 Email TAC.SECRETARIAT@transnet.net

4 Tax Clearance

The Respondent's original valid Tax Clearance Certificate must accompany the Quotation. Failure to provide this document with the RFQ submission will result in disqualification.

5 VAT Registration

The valid VAT registration number must be stated here: _____ [if applicable].

6 Legal Compliance

The successful Respondent shall be in full and complete compliance with any and all applicable national and local laws and regulations.

7 Changes to Quotations

Changes by the Respondent to its submission will not be considered after the closing date and time.

8 Pricing

All prices must be quoted in South African Rand on a fixed price basis, excluding VAT.

9 Prices Subject to Confirmation

Prices quoted which are subject to confirmation will not be considered.

10 Negotiations

Transnet reserves the right to undertake post-tender negotiations with selected Respondents or any number of short-listed Respondents.

11 Binding Offer

Any Quotation furnished pursuant to this Request shall be deemed to be an offer. Any exceptions to this statement must be clearly and specifically indicated.

12 Disclaimers

Transnet is not committed to any course of action as a result of its issuance of this RFQ and/or its receipt of a Quotation in response to it. Please note that Transnet reserves the right to:

- modify the RFQ's goods / service(s) and request Respondents to re-bid on any changes;
- reject any Quotation which does not conform to instructions and specifications which are detailed herein;
- disqualify Quotations submitted after the stated submission deadline;
- not necessarily accept the lowest priced Quotation;
- reject all Quotations, if it so decides;
- place an order in connection with this Quotation at any time after the RFQ's closing date;
- award only a portion of the proposed goods / service/s which are reflected in the scope of this RFQ;
- split the award of the order/s between more than one Supplier/Service Provider; or
- make no award at all.

Transnet reserves the right to exclude any Respondent from the bidding process who has been convicted of a serious breach of law during the preceding 5 [five] years, including but not limited to breaches of the Competition Act 89 of 1998. Respondents are required to indicate below whether or not they have been found guilty of a serious breach of law during the past 5 [five] years:

I/We _____ do hereby certify that I/we **have/have not been** found guilty during the preceding 5 [five] years of a serious breach of law, including but not limited to a breach of the Competition Act, 89 of 1998, by a court of law, tribunal or other administrative body. The type of breach that the Respondent is required to disclose excludes relatively minor offences or misdemeanours, e.g. traffic offences.

Where found guilty of such a serious breach, please disclose:

NATURE OF BREACH:

DATE OF BREACH: _____

Furthermore, I/we acknowledge that Transnet SOC Ltd reserves the right to exclude any Respondent from the bidding process, should that person or entity have been found guilty of a serious breach of law, tribunal or regulatory obligation.

13 EVALUATION CRITERIA: TRANSNET WILL UTILISE THE FOLLOWING CRITERIA [NOT NECESSARILY IN THIS ORDER] IN CHOOSING A SUPPLIER/SERVICE PROVIDER, IF SO REQUIRED:

- Administrative responsiveness - Completeness of response and returnable documents
- Substantive responsiveness - Prequalification criteria, if any, must be met
- Weighted evaluation based on 80/20 preference point system:
 - Pricing and price basis [firm] - whilst not the sole factor for consideration, competitive pricing and overall level of unconditional discounts¹ will be critical

Transnet will utilise the following formula in its evaluation of Price:

$$PS = 80 \left(1 - \frac{Pt - Pmin}{Pmin} \right)$$

Where:

- Ps* = Score for the Bid under consideration
- Pt* = Price of Bid under consideration
- Pmin* = Price of lowest acceptable Bid

- B-BBEE status of company

¹ Only unconditional discounts will be taken into account during evaluation. A discount which has been offered conditionally will, despite not being taken into account for evaluation purposes, be implemented when payment is effected.

Preference points will be awarded to a bidder for attaining the B-BBEE status level of contribution in accordance with the table below:

B-BBEE Status Level of Contributor	Number of points (80/20 system)
1	20
2	18
3	16
4	12
5	8
6	6
7	4
8	2
Non-compliant contributor	0

14 Validity Period

Transnet desires a validity period of 56 days from the closing date of this RFQ.

This RFQ is valid until _____.

15 Banking Details

BANK: _____

BRANCH NAME / CODE: _____

ACCOUNT HOLDER: _____

ACCOUNT NUMBER: _____

16 Company Registration

Registration number of company / C.C. _____

Registered name of company / C.C. _____

17 Disclosure of Prices Quoted

Respondents must indicate here whether Transnet may disclose their quoted prices and conditions to other Respondents:

YES NO

18 Returnable Documents

Returnable Documents means all the documents, Sections and Annexures, as listed in the tables below.

a) Respondents are required to submit with their Quotations the **Returnable Documents**, as detailed below.

Failure to provide all these Returnable Documents may result in a Respondent's disqualification. Respondents are therefore urged to ensure that all these Documents are returned with their Quotations.

All Sections, as indicated in the footer of each page, must be signed, stamped and dated by the Respondent. Please confirm submission of these mandatory Returnable Documents by so indicating [Yes or No] in the table below:

Returnable Documents	Submitted [Yes or No]
SECTION 1 : Notice to Bidders	
<ul style="list-style-type: none"> - Valid B-BBEE Verification Certificate [RSA Large Enterprises and QSEs] Note: failure to provide a valid B-BBEE Verification Certificate at the closing date and time of the tender will result in an automatic score of zero being allocated for B-BBEE scorecard - Valid B-BBEE certificate from auditor, accounting officer or SANAS accredited Verification Agency [RSA EMEs] Note: failure to provide a valid B-BBEE Verification Certificate at the closing date and time of the tender will result in an automatic score of zero being allocated for B-BBEE scorecard 	
SECTION 2 : Quotation Form	
<p>SECTION 3: Vendor Application Form</p> <ul style="list-style-type: none"> • Original cancelled cheque or bank verification of banking details • Certified copies of IDs of shareholder/directors/members [as applicable] • Certified copy of Certificate of Incorporation [CM29/CM9 name change] • Certified copy of share certificates [CK1/CK2 if C.C.] • Entity's letterhead • Certified copy of VAT Registration Certificate [RSA entities only] • Certified copy of valid Company Registration Certificate [if applicable] • Original valid Tax Clearance Certificate [Consortia / Joint Ventures / Sub-contractors must submit a separate Tax Clearance Certificate for each party] • Valid Workman's Compensation certificate from Department of Labour • Valid CIDB certificate grading 3 GB • Valid Asbestos certificate from Department of Labour 	

**Section 2
QUOTATION FORM**

I/We _____
hereby offer to supply the goods/services at the prices quoted in the Price Schedule below, in accordance with the conditions related thereto.

I/We agree to be bound by those terms and conditions in:

- the Standard Terms and Conditions for the Supply of Goods and Services to Transnet [available on request]; and
- any other standard or special conditions mentioned and/or embodied in this Request for Quotation.

I/We accept that unless Transnet should otherwise decide and so inform me/us, this Quotation [and, if any, its covering letter and any subsequent exchange of correspondence], together with Transnet's acceptance thereof shall constitute a binding contract between Transnet and me/us.

I/We further agree that if, after I/we have been notified of the acceptance of my/our Quotation, I/we fail to deliver the said goods/service/s within the delivery lead-time quoted, Transnet may, without prejudice to any other legal remedy which it may have, cancel the order and recover from me/us any expenses incurred by Transnet in calling for Quotations afresh and/or having to accept any less favourable offer.

Price Schedule

I/We quote as follows for the services required, on a "delivered nominated destination" basis, excluding VAT:

Item No	Description of Goods	Unit of Measure	Quantity	Unit Price (ZAR)	Total Price (ZAR)
1	ROOF REPAIRS PIETERMARITZBURG 02BP086	EA	1		

Delivery Lead-Time from date of purchase order : _____ **[Calendar days]**

Please note no retention fee will be withheld.

Notes to Pricing:

- All Prices must be quoted in South African Rand, exclusive of VAT
- To facilitate like-for-like comparison bidders must submit pricing strictly in accordance with this price schedule and not utilise a different format. Deviation from this pricing schedule could result in a bid being disqualified.
- Please note that should you have offered a discounted price(s), Transnet will only consider such price discount(s) in the final evaluation stage if offered on an unconditional basis.

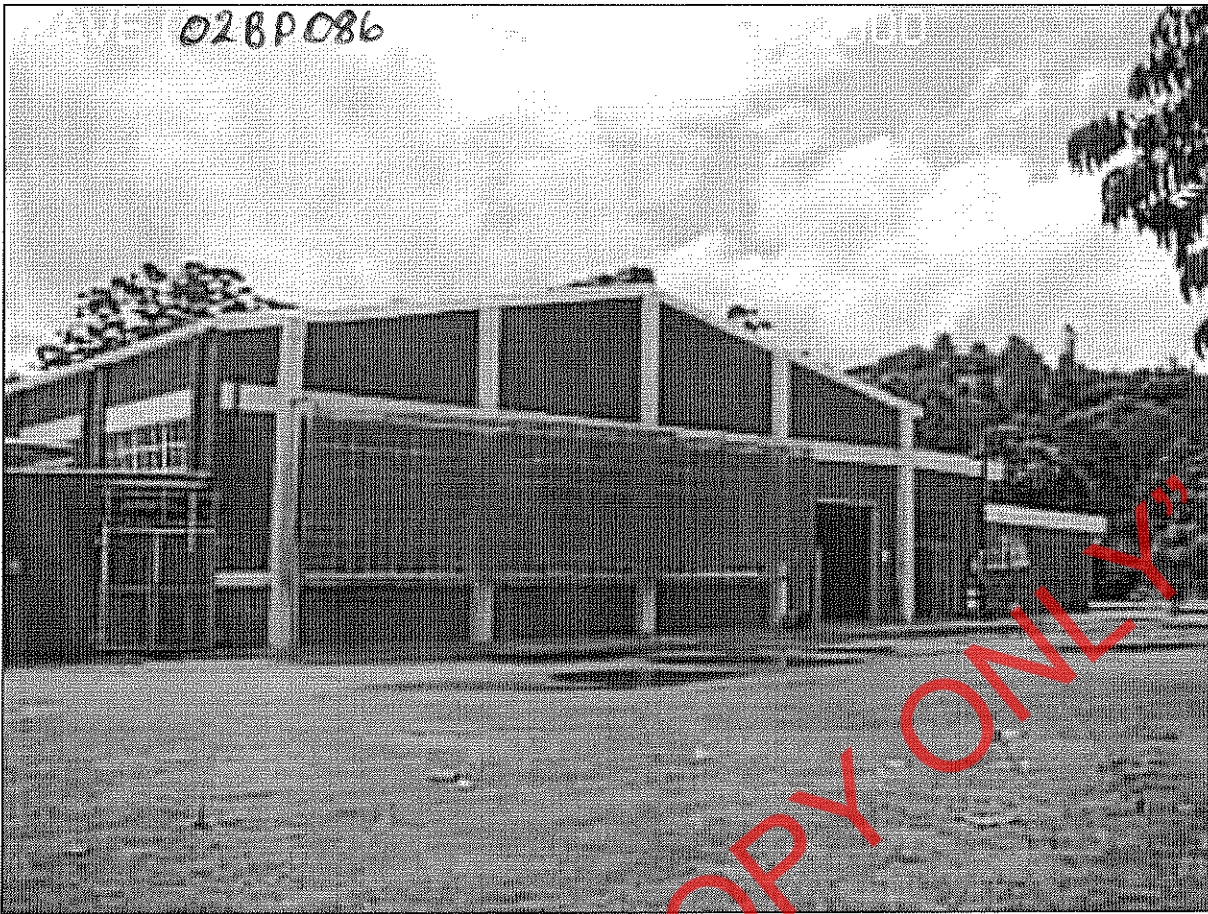

SUMMARY

REMOVE EXISTING ROOF ASBESTOS SHEETS

Real Estate Electrical and Civil workshop.

At corner Neville road Mayors walk

ASSET NO. 02BP086

1. Remove existing asbestos roof / barge boards / fascia boards / gutters and downpipes.
2. Supply container bins to transport waste asbestos.
3. All waste material must be removed from site and dumped at the approved dumping site and certificate required on completion of work.
4. Supply and fit new chrome deck roof sheets 0.5mm thick sheets / colour white
5. Supply and fit new chrome deck gutters / ridging / fascia / barge boards.
6. Supply and fit new pvc downpipes.
7. Supply and fit new continuous ridge ventilators.
8. Supply and erect scaffolding for this time of project.
9. Remove and replace with new suspended ceiling.
10. Supply and fit new rafters / purlins and brandering.
11. Supply and paint sprockets / purlins
12. Health and safety and asbestos regulations must apply to this project.

“PREVIEW COPY ONLY”

BUILDING DESCRIPTION: Real Estate Electrical and Civil Workshop

CITY TOWN: PMB

ASSET NO: 02BP086

CONTRACTOR TO CHECK ALL MEASUREMENTS AND QUANTITIES BEFORE ORDER ANY MATERIAL, MEASUREMENTS AND QUANTITIES ON WORK LISTS IS ONLY FOR TENDER PURPOSE.

ITEM NO SPECIFICATIONS FOR ITEMS

CEILING

11 Work description: Fit additional ceiling joists
Provide and fix in position additional 114 x 38mm beams where shown or as necessary between existing tie beams where support for brandering is required. Fix to existing tie beams with 114 x 38mm runner fitted over existing tie beams. And with 50 x 38mm hangers.

12 Work description: Install brandering complete for rhino board or Nutec fibre cement ceiling boards
Branding for ceilings shall be 38 x 38mm, for truss spacing up to 1000mm. Purlins 75mm x 50mm
Branding for ceilings shall be 38 x 50mm, for truss spacing up to 1001mm to 1200mm
Branding for ceilings shall be 50 x 50mm, for truss spacing up to 1201mm to 1400mm
Main branders shall be at right angles to tie beams and spaced at 400mm centers.
Branders shall be fixed with galvanized nails, accordance with SABS Specification 563. All brandering shall bear the standardisation mark of the South African Bureau of Standards.
The brandering shall be securely spiked up to the supporting timbers with 90 mm wire nails. Cross brandering shall be cut in between the longitudinal brandering, all securely skew nailed to same with 90 mm wire nails. The sizes and spacing of brandering for the various types of ceilings shall be as follows: (a) Gypsum plaster board: fixed parallel to the ceiling boards at centers not exceeding 450 mm for 900 mm wide boards and 600 mm for 1200 mm wide boards. Brandering shall also be fixed around edges of ceilings where required for fixing cornices. Size 38 x 38 mm, at not exceeding 450 mm centers in one direction at right angles to the supporting timbers where metal H-section jointing strips are to be used.

29 Work description: Remove suspended ceiling complete

30 Work description: Install suspending ceiling complete as per type specified in fault list
Supply and install suspended ceiling. Use Donn Products ceiling grid & accessories or Macsteel interior systems grids and accessories. Use the LSM 25 cornice wall moulding from Donn and T37 main tee with T32 cross tee and or similar system from Macsteel Interior systems. Use 2.5mm pre stress galvanized wire, 4mm rod suspension system or 19mm wide galvanized strap as hangers. The installation shall be done according to the specification of the relevant manufacture. Supply and install 595mm x 1195mm x 12,7mm thick laminated white vinyl Rhinodek tiles. The tile should be installed according to the manufacture's specification. Hold down clips must be used to hold the boards firmly in position. After installation the ceiling shall be level and all grid strips shall be straight.

FIT/REPLACE ITEMS/FURNITURE

493 Work description:

ROOF

500 Work description: Remove existing asbestos roof sheets for scrap
Asbestos must be stacked in bins for transport .
Take care when removing sheets off roof.

501 Work description: Supply new chrome deck roof sheets partly and polycarbonate translucent sheets / IBR 0,58mm thick
Provide and fix new sheets as specified in wordlist Provide and fix new sheets to steel purlins.

ITEM NO SPECIFICATIONS FOR ITEMS

502 Work description: Supply ridging partly / IBR
Provide new ridging and fixed with screws.

532 Work description: Paint expose roof timber purlins
Item include cleaning by washing off al dirt. Remove all loose, chalky, flaking, peeling paint from wood, sanding and wipe off sanding dust with damp cloth and leave to dry before applying paint.
NEW ROOF TIMBER PAINTED/CARBORLINEUM: Apply one coat approved exterior wood primer for roof timber specified to be painted before timber are fixed in position, apply one coat universal undercoat and one coat gloss enamel. For roof timber specified to be carborlineum, apply two coats carborlineum.

533 Work description: Paint expose roof timber sprockets
Item include cleaning by washing off al dirt. Remove all loose, chalky, flaking, peeling paint from wood, sanding and wipe off sanding dust with damp cloth and leave to dry before applying paint.
NEW ROOF TIMBER PAINTED/CARBORLINEUM: Apply one coat approved exterior wood primer for roof timber specified to be painted before timber are fixed in position, apply one coat universal undercoat and one coat gloss enamel. For roof timber specified to be carborlineum, apply two coats carborlineum.

541 Work description: Fit continuous ridge ventilator complete
Attached drawing required

777 Transport waste asbestos roof sheets to approved dump site

778 Occupational health and safety act and asbestos regulations

FACIA/BARGE BOARDS

543 Work description: Remove existing asbestos barge board
required, take down and remove from site.

545 Work description: Fit / barge board
Carefully loosen sheet iron capping where applicable or take down and remove galvanized capping where applicable. Take down barge boards and remove from site. Were necessary cut roof sheeting to be level with purline ends. The verges of roof to be finished with 225 x 10mm thick plain pressed fibre cement barge boards with bottom ends projecting 100mm beyond fascia board or in line with outer edge of gutter stop end, The edge of barge boards at bottom end shall be cut vertical level. The barge boards shall be securely fixed to projecting purlin ends with galvanized barge board brackets. Full length boards shall be used if necessary to joint in section of barge board the section shall not be shorter than 500mm.

547 Work description: Fit / Replace fascia board and bird proofing
Provide 230 x 12mm chrome deck fascia board. Fix a chrome deck fascia boards to existing wood fascia boards at 900mm intervals and 75mm from both sides of joints with 2 no 8 x 38mm countersunk woodscrews, one 30 mm from top edge and 30mm from bottom edge. Use right type of jointer on joints. The edge of facia boards shall be cut vertical level. Full length boards shall be used if necessary to joint in section of facia board the section shall not be shorter than 500mm.

GUTTERS/DOWNPIPES

554 Work description: Replace gutters

555 Work description: Remove gutter and down pipe complete including brackets
Remove gutters, gutter brackets, down pipes and down pipe holder bats completely and remove from site. Fill down pipe holder bats holes neatly with mortar.

ITEM NO SPECIFICATIONS FOR ITEMS

558 Work description: Replace gutters complete

Galvanized sheet iron gutters shall have beaded edges and shall be in lengths of not less than 5 metres, except the last portion to make up the length. The part used to make up the length shall not be less than 500mm. All the joints shall be seal with paintable water proof sealant and 4mm diameter x 6mm long pop rivets. The sealant shall be applied between the gutters. The joint shall have 3 pop rivets on sides and 3 at the bottom of the gutter. The down pipe outlets can be soldered or pop riveted tot the gutter and sealed with acrylic sealer. The size of the outlet shall allow the down pipe to press right up to the bottom of the gutter. All the joints shall be waterproof and the gutters shall be in a straight line. Gutters shall be laid to proper falls and be provided with angles, stopped ends and outlet nozzles as required. Gutters shall be fixed on galvanized mild steel brackets of size specified and bent to shape of gutters with front end taken up to underside of beaded edge of gutter and each twice screwed to roof timbers. Gutters shall be bolted to brackets at front with 6 mm diameter galvanized gutter bolts, one to each bracket, positioned close to underside of beaded edge of gutter. Brackets shall be spaced but distance between brackets shall not exceeding 1m.

566 Work description: Fit/replace down pipe complete

Down pipes shall be fitted with all necessary offsets shoes and holder bats. Down pipes shall be fixed vertical level.

SCAFOLDING ...

775 Work description: Scaffolding erect and take down

A principal contractor who intendst o carry out any construction works shall-(a) before carrying out that work, notify the provincial director in writing of the construction work if it includes-working at a height greater than 3 meters above ground or a landing. "scaffold" means any temporary elevated platform and supporting structure used for providing access to and supporting workmen or materials or both; Scaffolding shall be done by a competent person, "competent person" means any person having the knowledge, training, experience and qualifications specific to the work or task being performed: Provided that where appropriate qualifications and training are registered in terms of the provisions of the South African Qualifications Authority Act, 1995 (Act No. 58 of 1995), these qualifications and training shall be deemed to be the required qualifications and training; Every contractor using access scaffolding, shall ensure that such scaffolding, when Used, complies with the safety standards incorporated for this purpose into these Regulations under section 44 of the Act. A contractor shall ensure that all scaffolding work operations are carried out under the supervision of a competent person who has been appointed in writing and that all scaffold erectors, team leaders and inspectors are competent to carry out their work.

CONTRACTOR TENDER PRICE LIST PER ITEM

BUILDING DESC: Real Estate Electrical and Civil Workshop

CITY/TOWN: PMB

CONTRACTOR TENDER PRICE LIST FOR INTERIOR AND EXTERIOR WORK

MEASUREMENTS AND OR QUANTITIES DO NOT INCLUDE OFFCUTS OR WASTE , ALL MEASUREMENT OF MATERIAL IS MEASURE AS NETT FIXED. CONTACTOR TO ADD HIS OWN %

CONTRACTOR TO CHECK ALL MEASUREMENTS AND QUANTITIES BEFORE ORDER ANY MATERIAL, MEASUREMENTS AND QUANTITIES IS ONLY FOR TENDER

IF CONTRACTOR IS VAT REGISTER ITEM PRICES MUST EXCLUDE VAT!

To be supplied by the Contractor:

The Contractor shall provide all labour, material, transport, consumable stores, plant, equipment, tools, services, materials and ingredients of every description required for the carrying out and completion of the WORK as per the attached worklist and specification and as may be ordered by the Project Manager.

Move of furniture in same room if necessary is included in all items. All normal preparation include sanding, stopping and wash of items to be painted as specified by paint manufacturer is included in all the paint items. All scaffolding and use of ladders up to 4.50m high interior and exterior if necessary is included in all the items. All work shall be done to attached specifications and shall comply with the National building regulations. All material shall be fitted or applied as specified by the manufacturer.

ASSET NO: 02BP086

Page 1 of 3 SUB TOTAL PAGE 1

ITEM NO	FAULT DISCRPTION	ITEM TOTAL	MEASURE UNIT	UNIT RATE	ITEM AMOUNT
CEILINGS					
11	SUPPLY MATERIAL AND FIT ADDITIONAL 114mm X 38mm BEAMS BETWEEN TRUSSES IF TRUSSES IS MORE THAN 1.2m APART OR WHERE NECESSARY TO FIT NEW CEILING	430	M		
12	SUPPLY MATERIAL AND INSTALL BANDERING COMPLETE, INCLUDE SKEW NAILING (SPECIFY SIZE ACCORDING TABLE IN SPECIFICATIONS) PURLINS AND BRANDERING	580	M ²		
29	REMOVE SUSPENDED CEILINGS FOR SCRAP	520	M ²		
30	SUPPLY MATERIAL AND INSTALL DONN OR MACSTEEL TYPE SUSPENDING CEILING WITH 12,7MM THICK LAMINATED WHITE VINYL RHINODEK TILES COMPLETE	520	M ²		
FIT/REPLACE ITEMS/ FURNITURE					
493	REMOVE FURNITURE TO ROOM UP TO 20m AND REPLACE TO ORIGINAL POSITION WHEN WORK IS COMPLETE IS ONE ACTION, ITEMS THAT CAN BE CARRY BY ONE PERSONE =1 EACH, ITEMS THAT MUST BE CARRY BY TWO PERSONE =2 EACH, 3 PERSONS =3 EACH	10	EA		
ROOF					
500	REMOVE ASBESTOS ROOF SHEETS FROM WORKSHOP BUILDING ROOF	1400	M ²		
501	SUPPLY NEW CHROME DECK ROOF SHEETS / IBR 0.58mm FULL HARD AND POLYCARBONATE TRANSLUCENT SHEETS COLOUR OF ROOF TO BE WHITE	1400	M ²		
502	SUPPLY AND FITNEW CHROME DECK RIDGING PARTLY FOR / IBR ROOF	28	M		

--

ITEM NO	FAULT DISCRPTION	ITEM TOTAL	MEASURE UNIT	UNIT RATE	ITEM AMOUNT
532	SUPPLY PAINT AND PAINT EXPOSE ROOF TIMBER (PURLINS 75 mm X 50 mm) 1 COAT UNIVERSAL UNDERCOAT AND 2 COAT WHITE GLOSS ENAMEL, BARE WOOD AREAS SHALL BE SPOT PRIME WITH WOOD PRIMER BEFORE APPLYING UNDERCOAT	180	M		
533	SUPPLY PAINT AND PAINT EXPOSE ROOF TIMBER (SPROCKETS 114 mm X 38 mm) 1COAT UNIVERSAL UNDERCOAT AND 2 COAT WHITE GLOSS ENAMEL. BARE WOOD AREAS SHALL BE SPOT PRIME WITH WOOD PRIMER	54	M		
541	SUPPLY AND FIT CONTINUOUS RIDGE VENTILATOR COMPLETE WITH OVERALL LENGTH 2,400MM DRAWING IS ATTACHED WITH DIMENSIONS	6	EA		
777	TRANSPORT EXISTING ASBESTOS ROOF SHEETS IN CONTAINER BINS TO APPROVED DUMP SITE	3	JOB		
778	HEALTH AND SAFETY AND ASBESTOS REGULATIONS	1	JOB		
FACIA/BARGE BOARDS					
543	REMOVE EXISTING ASBESTOS BARGE BOARDS	76	M		
545	SUPPLY AND FIT / CHROME DECK BARGE BOARD , ITEM INCLUDE H-PROFILE JOINERS AS NECESSARY	76	M		
547	SUPPLY AND FIT / REPLACE FASCIA BOARD WITH CHROME DECK FACIA BOARDS INCLUDE H-PROFILE FASCIA JOINERS AND H-PEOFILE FASCIA CORNER JOINTERS.	178	M		
GUTTERS/DOWNPIPES					
554	SUPPLY MATERIAL AND REPLACE GUTTERS PARTLY (Size 160 mm x 110 mm)	150	M		
555	REMOVE GUTTER AND DOWNPIPE COMPLETE INCLUDE BRACKETS (Size mm x mm)	150	M		
558	SUPPLY MATERIAL AND FIT 160mm x 100mm SQUARE GUTTERS COMPLETE INCLUDE ALL CORNERS AND STOPENDS AS NECESSARY CHROME DECK	150	M		
566	SUPPLY MATERIAL AND FIT SPREADER / ROUND DOWNPIPE TO MATCH GUTTERS COMPLETE ITEM INCLUDE ONE OFFSET UP TO 6,00m LONG FOR INLAND AND PVC GUTTER DOWNPIPE FOR AREA	26	EA		
SCAFFOLDING					
775	SCAFFOLDING EXSTRA OVER ITEM TO REPAIR AND PAINT WORK ON DOUBLE /OR SPECIFY STOREY BUILDINGS, NOT GABLE SIDE OF BUILDING, ITEM IS TO ERRECT SCAFFOLD X 2 FOR TWO COAT PAINT AND INCLUDE ALL REPAIR WORK TO BE DONE	4	JOB		

PRELIMINARY COPY ONLY

--

ITEM NO	FAULT DISCRPTION	ITEM TOTAL	MEASURE UNIT	UNIT RATE	ITEM AMOUNT
---------	------------------	------------	--------------	-----------	-------------

Preliminary and General:
 P and G shall include all cost not directly relate to a specific item on the schedule of prices and rates. All items not specifically mentioned in the Schedule of Rates and prices and form part of contractor's requirements such as cost of stationery, as well as establishment of workers on site and removal of site establishment, it will also include the handing over of the site to the contractor and the handing back of the site after completion of work .

P + G

--

TOTAL CIVIL

--

TOTAL ELECTRICAL

--

SUB TOTAL

--

VAT

--

TOTAL

--

TOTAL PRICE CARRY OVER TO TENDER DOCUMENT.

"PREVIEW COPY ONLY"

EXTERIOR WORK LIST

ASSET NO 02BP086

Real Estate Electrical and Civil Workshop

PMB

No	EXTERIOR WORK ITEM	UNIT	FRONT	LEFT	BACK	RIGHT	TOTAL
CEILING							
11	SUPPLY MATERIAL AND FIT ADDITIONAL 114mm X 38mm BEAMS BETWEEN TRUSSES IF TRUSSES IS MORE THAN 1,2m APART OR WHERE NECESSARY TO FIT NEW CEILING	M	0	0	430	0	430
12	SUPPLY MATERIAL AND INSTALL BANDERING COMPLETE, INCLUDE SKEW NAILING (SPECIFY SIZE ACCORDING TABLE IN SPECIFICATIONS) PURLINS AND BRANDERING Brandering and Purlins	M^2	0	0	580	0	580
29	REMOVE SUSPENDED CEILING FOR SCRAP	M^2	0	0	520	0	520
30	SUPPLY MATERIAL AND INSTALL DONN OR MACSTEEL TYPE SUSPENDING CEILING WITH 12,7MM THICK LAMINATED WHITE VINYL RHINODEK TILES COMPLETE	M^2	0	0	520	0	520
FIT/REPLACE ITEMS/ FURNITUR							
493	REMOVE FURNITURE TO ROOM UP TO 20m AND REPLACE TO ORIGINAL POSITION WHEN WORK IS COMPLETE IS ONE ACTION, ITEMS THAT CAN BE CARRY BY ONE PERSONE =1 EACH, ITEMS THAT MUST BE CARRY BY TWO PERSONE =2 EACH, 3 PERSONS =3 EACH	EA	0	0	10	0	10
ROOF							
500	REMOVE ASBESTOS ROOF SHEETS FROM WORKSHOP BUILDING ROOF	M^2	520	0	880	0	1400
501	SUPPLY NEW CHROME DECK ROOF SHEETS / IBR 0.58mm FULL HARD AND POLYCARBONATE TRANSLUCENT SHEETS COLOUR OF ROOF TO BE WHITE Polycarbonate translucent sheets between bays 6 ea Colour of roof to be white.	M^2	520	0	880	0	1400
502	SUPPLY AND FIT NEW CHROME DECK RIDGING PARTLY FOR / IBR ROOF Fix angle ridge capping / Chrome deck	M	14	0	14	0	28
532	SUPPLY PAINT AND PAINT EXPOSE ROOF TIMBER (PURLINS 75 mm X 50 mm) 1 COAT UNIVERSAL UNDERCOAT AND 2 COAT WHITE GLOSS ENAMEL, BARE WOOD AREAS SHALL BE SPOT PRIME WITH WOOD PRIMER BEFORE APPLYING UNDERCOAT	M	0	0	180	0	180
533	SUPPLY PAINT AND PAINT EXPOSE ROOF TIMBER (SPROCKETS 114 mm X 38 mm) 1COAT UNIVERSAL UNDERCOAT AND 2 COAT WHITE GLOSS ENAMEL. BARE WOOD AREAS SHALL BE SPOT PRIME WITH WOOD PRIMER	M	0	0	54	0	54

No	EXTERIOR WORK ITEM	UNIT	FRONT	LEFT	BACK	RIGHT	TOTAL
ROOF							
541	SUPPLY AND FIT CONTINUOUS RIDGE VENTILATOR COMPLETE WITH OVERALL LENGTH 2,400MM DRAWING IS ATTACHED WITH DIMENSIONS Drawing attached required	EA	6	0	0	0	6
777	TRANSPORT EXISTING ASBESTOS ROOF SHEETS IN CONTAINER BINS TO APPROVED DUMP SITE	JOB	1	0	2	0	3
778	HEALTH AND SAFETY AND ASBESTOS REGULATIONS	JOB	1	0	0	0	1
FACIA/BARGE BOARDS							
543	REMOVE EXISTING ASBESTOS BARGE BOARDS	M	0	38	0	38	76
545	SUPPLY AND FIT / CHROME DECK BARGE BOARD , ITEM INCLUDE H-PROFILE JOINERS AS NECESSARY Chrome deck barge boards	M	0	38	0	38	76
547	SUPPLY AND FIT / REPLACE FASCIA BOARD WITH CHROME DECK FACIA BOARDS INCLUDE H-PROFILE FASCIA JOINERS AND H-PEOFILE FASCIA CORNER JOINTERS. Chrome deck fascia and bird proofing on profile sheets	M	40	0	138	0	178
GUTTERS/DOWNPINES							
554	SUPPLY MATERIAL AND REPLACE GUTTERS PARTLY (Size 160 mm x 110 mm)	M	40	0	110	0	150
555	REMOVE GUTTER AND DOWNPIPE COMPLETE INCLUDE BRACKETS (Size mm x mm)	M	40	0	110	0	150
558	SUPPLY MATERIAL AND FIT 160mm x 100mm SQUARE GUTTERS COMPLETE INCLUDE ALL CORNERS AND STOPENDS AS NECESSARY CHROME DECK Chrome deck gutters	M	40	0	110	0	150
566	SUPPLY MATERIAL AND FIT SPREADER / ROUND DOWNPIPE TO MATCH GUTTERS COMPLETE ITEM INCLUDE ONE OFFSET UP TO 6,00m LONG FOR INLAND AND PVC GUTTER DOWNPIPE FOR AREA Downpipes size 160mm diameter and spreader pipes	EA	7	0	19	0	26
SCAFFOLDING							
775	SCAFFOLDING EXTRA OVER ITEM TO REPAIR AND PAINT WORK ON DOUBLE /OR SPECIFY STOREY BUILDINGS, NOT GABLE SIDE OF BUILDING, ITEM IS TO ERRECT SCAFFOLD X 2 FOR TWO COAT PAINT AND INCLUDE ALL REPAIR WORK TO BE DONE	JOB	1	1	1	1	4

FIG. 4 DIMENSIONS OF VENTILATOR

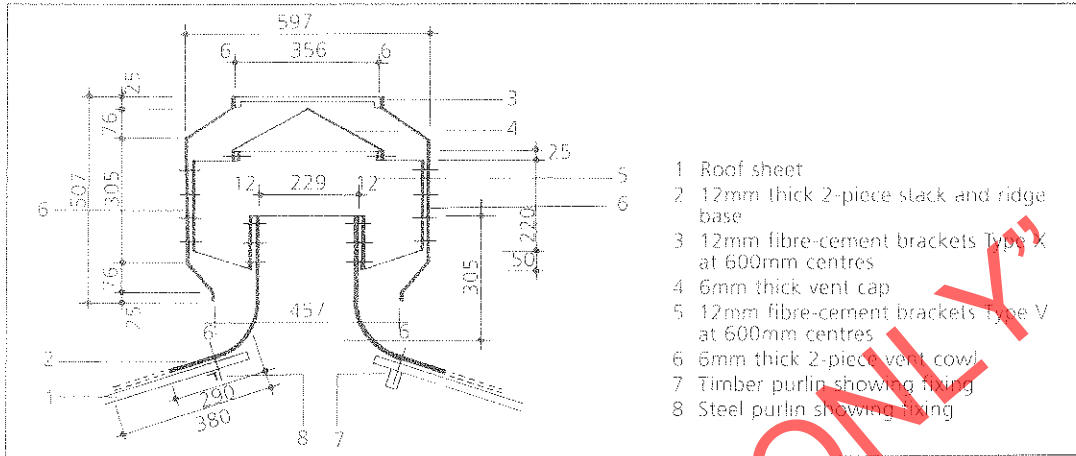

NB: • The exhaust capacities are calculated for 600mm long sections between partitions and under average conditions of wind velocity and temperature differences. Effective height of buildings has varied from 3m to 15m.

• When ordering quote angle and length of base wing. (230mm minimum and 380mm maximum.)

CONTINUOUS RIDGE VENTILATOR

TABLE 3 PARTS INVENTORY

Product No.	Quantity per 2.4m Ventilator	Description
560-235	1	Complete ventilator
560-240	1	Vent cap
560-241	1	Vent cowl left hand
560-242	1	Vent cowl right hand
560-243	1	Ridge base left hand
560-244	1	Ridge base right hand
560-245	4	X type brackets
560-246	4	Y type brackets
560-247	1	Side cover A - socket
560-248	2	Side cover B - spigot



CONTINUOUS RIDGE VENTILATOR

Product no. complete	560-235
Overall length	2400mm
Width ventilator	597mm
Nominal thickness	6mm and 12mm
Average mass	160kg

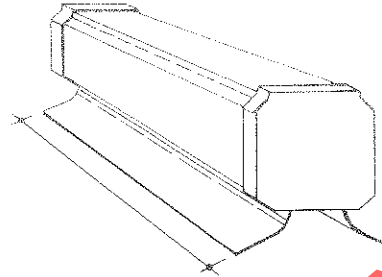
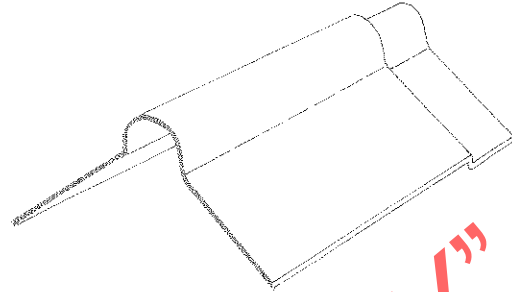

TABLE 3 EXHAUST CAPACITIES

Temp. difference	Effective height of building	Wind velocity in km/h		
		5	10	15
Celsius	m	m ³ per minute extracted		
4°	3	4,9	7,4	10,3
	6	6,1	8,8	10,9
	9	7,2	9,1	11,5
	12	8,1	9,8	12,1
	15	8,8	10,5	12,7
6°	3	5,5	7,8	10,6
	6	7,2	9,1	11,5
	9	8,5	10,1	12,4
	12	9,6	11,1	13,2
	15	10,6	12,0	13,9
8°	3	6,1	8,3	10,9
	6	8,1	9,8	12,1
	9	9,6	11,1	13,2
	12	10,9	12,3	14,2
	15	12,1	13,3	15,1
10°	3	6,7	8,7	11,2
	6	8,9	10,5	12,7
	9	10,6	12,0	13,9
	12	12,1	13,3	15,1
	15	13,5	14,5	16,2
12°	3	7,2	9,1	11,5
	6	9,6	11,1	13,2
	9	11,5	12,8	14,7
	12	13,2	14,3	16,0
	15	14,7	15,7	17,2

PURPOSE MADE PLAIN WING FIXED ANGLE RIDGE CAPPING

Overall length 2 030mm
 Net cover length 1 950mm
 Nominal thickness 6 mm
 Average mass 6 kg
 When ordering quote angle required.



Application

The plain wing fixed angle ridge capping is a purpose made ridge capping and can be ordered to suit any pitch of roof. It is used as indicated in Fig.8.

FIG.8 TYPICAL APPLICATION OF PURPOSE MADE FIXED ANGLE RIDGE CAPPING

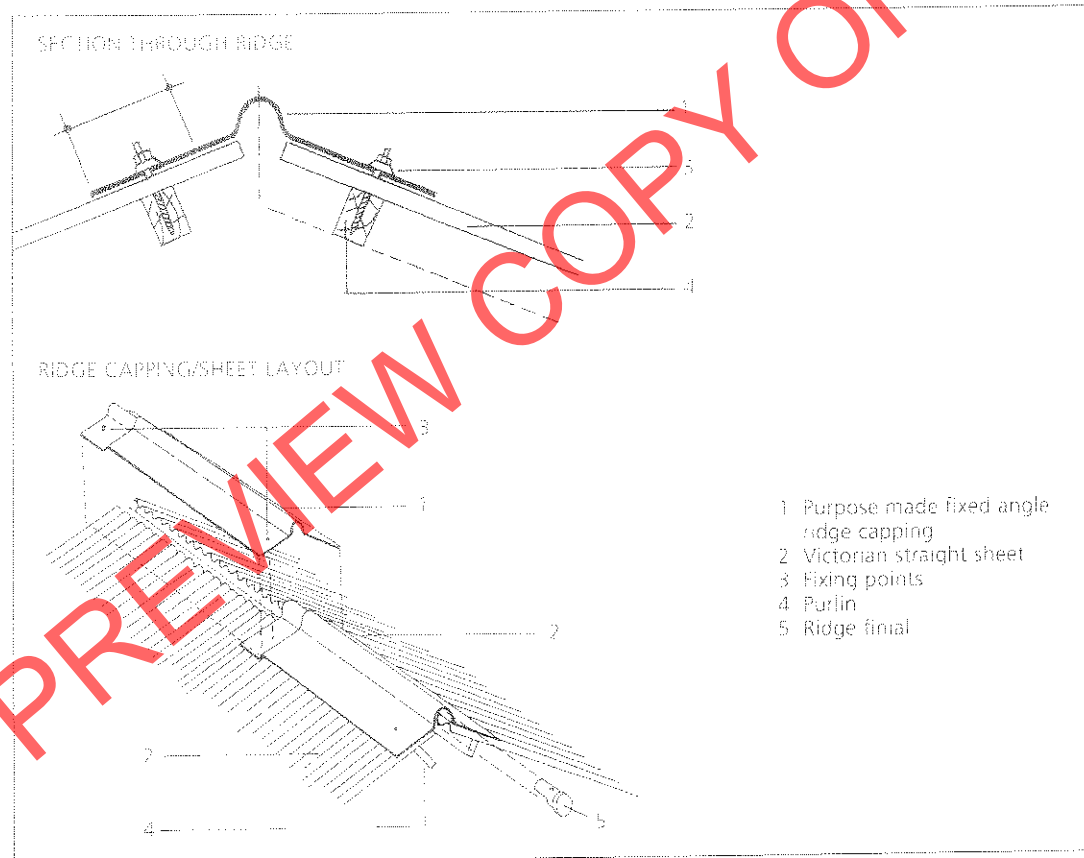

NB: • If laid below 15° or if dust proofing is required, the openings between the straight sheet and the plain wing fixed angle ridge capping should be sealed with bitumen impregnated closures

SPAN 2 AND SPAN 3 BIRDPROOFING PIECE

Product no. (left to right fixing)	522-210
Product no. (right to left fixing)	522-212
Standard length	900mm
Net cover length	900mm
Nominal thickness	6mm
Average mass per length	1,63kg

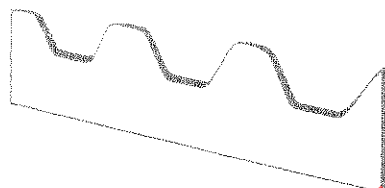

left to right fixing illustrated

Application Possibilities

Used for birdproofing closures on roofing and vertical cladding.

FIG.19 TYPICAL USES FOR SPAN 2 AND SPAN 3 BIRDPROOFING PIECE

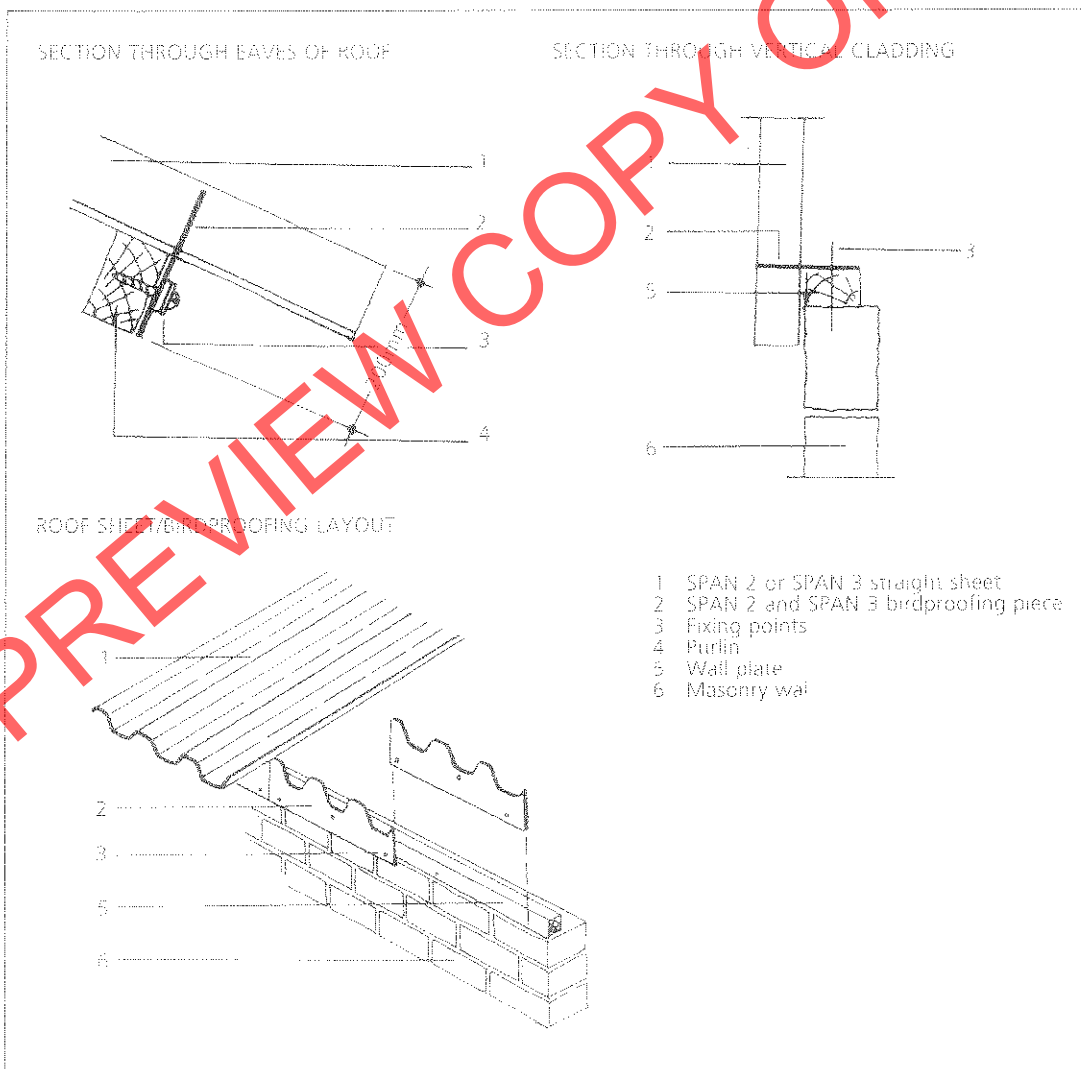

NB: • The SPAN 2 and SPAN 3 birdproofing piece is designed to be butt-jointed and fixed in the same direction as the straight sheeting.

- It can be fixed with nails or wood screws
- Fixing to steel can be done with pop rivets or self-tapping screws.

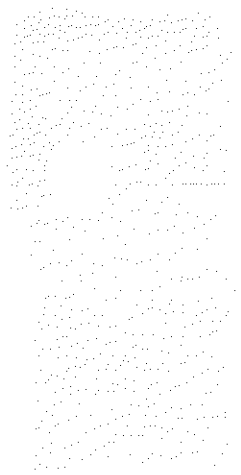

Accessories

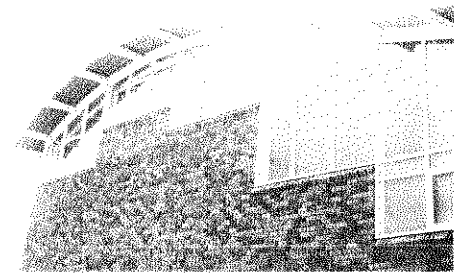

Craft Lock can be ordered in the following materials:

Material	Thickness
Galvanised in Z275 and Z600	0.58 mm
Chromadek	0.58 mm
Copper Sheet	0.60 mm
Aluminium mill finished sheets	0.70 mm, 0.80mm, 0.90mm
Aluminium colour coated sheets	0.70 mm, 0.80mm, 0.90mm
Grade 304 Stainless Steel	0.50 mm
Polycarbonate Translucent Sheets	1.20 mm

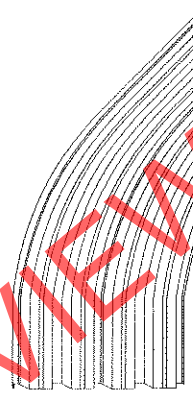

Bullnosing
To radius of 450mm minimum

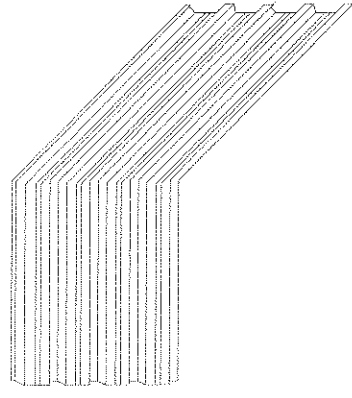

Angle Bend
From 30° to 90°

“PREVIEW COPY ONLY”

Craft-Lock can be cranked to continuous curves (minimum 450mm radius). Ridge cranking facilities are available to crank Craft-Lock sheets. Radii in excess of 28m can be rolled to the required curve on site without cranking. Take note that in event of a bullnose roof detail the female side of the roof sheet has to be closed with a bullnose lip closing tool.

Regarding the roof sheet the following is to be noted:

- 1) An international trade mark has been attained
- 2) It is internationally patented
- 3) For accessories also refer to Flashing supplement in this folder

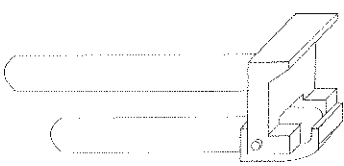

BULLNOSE LIP CLOSURE

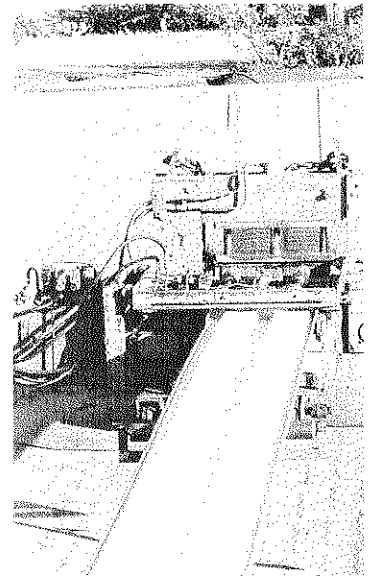

REQUEST FOR QUOTATION

RFQ CRAC DNR 9786

SUPPLY OF ROOF REPAIRS (ASBESTOS) PIETERMARITZBURG.

INFORMATION SESSION

R F Q SITE MEETING

A COMPUSORY SITE MEETING WILL BE HELD AT THE FOLLOWING VENUE

VENUE: PIETERMARITZBURG NEVILLE ROAD.

TIME: 10H00

DATE: 27 FEBRUARY 2013.

The site meeting is compulsory and companies not attending are overlooked in the tender award process.

ATTENDANCE CERTIFICATE

This is to certify that _____

Representative/s of _____

Has/have today attended the Tender briefing in respect of the proposed:

TRANSNETS REPRESENTITIVE

TENDRERS REPRESENTITIVE

DATE: _____

VERY IMPORTANT

ANY TENDERER NOT ATTENDING THE SITE MEETING WILL AUTOMATICALLY BE EXCLUDED FROM THE BUSINESS AWARDING PROCESS.

Section 3 VENDOR APPLICATION FORM

Respondents are to furnish the following documentation and complete the Vendor Application Form below:

1. **Original** cancelled cheque **OR** letter from the Respondent's bank verifying banking details [with bank stamp]
2. **Certified** copy of Identity Document(s) of Shareholders/Directors/Members [where applicable]
3. **Certified** copy of Certificate of Incorporation, CM29 / CM9 [name change]
4. **Certified** copy of Share Certificates [CK1/CK2 if CC]
5. A letter on the company's letterhead confirm physical and postal addresses
6. **Original** valid SARS Tax Clearance Certificate
7. **Certified copy** of VAT Registration Certificate
8. **Certified copy** of valid Company Registration Certificate [if applicable]
9. A signed letter from your auditor or accountant confirming most recent annual turnover figures



“PREVIEW COPY ONLY”

Company trading name			
Company registered name			
Company Registration Number or ID Number if a Sole Proprietor			
Form of entity [V]	<input type="checkbox"/> CC	<input type="checkbox"/> Trust	<input type="checkbox"/> Pty Ltd <input type="checkbox"/> Limited <input type="checkbox"/> Partnership <input type="checkbox"/> Sole Proprietor
VAT number [if registered]			
Company telephone number			
Company fax number			
Company email address			
Company website address			
Bank name			Branch & Branch code
Account holder			Bank account number
Postal address			Code
Physical Address			

Code

Contact person

Designation

Telephone

Email

Annual turnover range [last financial year] < R5 m R5 - 35 m > R35 m

Does your company provide Products Services Both

Area of delivery National Provincial Local

Is your company a public or private entity Public Private

Does your company have a Tax Directive or IRP30 Certificate Yes No

Main product or services [e.g. Stationery/Consulting]

Complete B-BBEE Ownership Details:

% Black ownership % Black women ownership % Disabled Black ownership

Does your company have a B-BBEE certificate Yes No

What is your B-BBEE status [Level 1 to 9 / Unknown]

How many personnel does the firm employ Permanent Part time

If you are an existing Vendor with Transnet please complete the following:

Transnet contact person

Contact number

Transnet Operating Division

Duly authorised to sign for and on behalf of Company / Organisation:

Name		Designation	
Signature		Date	



NON-DISCLOSURE AGREEMENT

entered into by and between

TRANSNET SOC LTD

Registration Number 1990/000900/30

and

Registration Number _____

RFP Number : ERAC DNR 9786.

“PREVIEW COPY ONLY”

TABLE OF CONTENTS

1	INTERPRETATION	3
2	CONFIDENTIAL INFORMATION	4
3	RECORDS AND RETURN OF INFORMATION	5
4	ANNOUNCEMENTS	5
5	DURATION	5
6	PRINCIPAL	5
7	ADEQUACY OF DAMAGES	6
8	PRIVACY AND DATA PROTECTION	6
9	GENERAL	6

“PREVIEW COPY ONLY”

THIS AGREEMENT is made between

Transnet SOC Ltd [Transnet] [Registration No. 1990/000900/30]

whose registered office is at 49th Floor, Carlton Centre, 150 Commissioner Street, Johannesburg 2001,

and

_____ **[the Company]** [Registration No _____]

whose registered office is at _____

WHEREAS

Transnet and the Company wish to exchange Information [as defined below] and it is envisaged that each party may from time to time receive Information relating to the other in respect thereof. In consideration of each party making available to the other such Information, the parties jointly agree that any dealings between them shall be subject to the terms and conditions of this Agreement which themselves will be subject to the parameters of the Bid Document.

IT IS HEREBY AGREED

1 INTERPRETATION

In this Agreement:

- 1.1 **Agents** mean directors, officers, employees, agents, professional advisers, contractors or sub-contractors, or any Group member;
- 1.2 **Bid or Bid Document** means Transnet's Request for Information [**RFI**] Request for Proposal [**RFP**] or Request for Quotation [**RFQ**], as the case may be;
- 1.3 **Confidential Information** means any information or other data relating to one party (the **Disclosing Party**) and/or the business carried on or proposed or intended to be carried on by that party and which is made available for the purposes of the Bid to the other party (the **Receiving Party**) or its Agents by the Disclosing Party or its Agents or recorded in agreed minutes following oral disclosure and any other information otherwise made available by the Disclosing Party or its Agents to the Receiving Party or its Agents, whether before, on or after the date of this Agreement, and whether in writing or otherwise, including any information, analysis or specifications derived from, containing or reflecting such information but excluding information which:
 - a) is publicly available at the time of its disclosure or becomes publicly available (other than as a result of disclosure by the Receiving Party or any of its Agents contrary to the terms of this Agreement); or

- b) was lawfully in the possession of the Receiving Party or its Agents (as can be demonstrated by its written records or other reasonable evidence) free of any restriction as to its use or disclosure prior to its being so disclosed; or
 - c) following such disclosure, becomes available to the Receiving Party or its Agents (as can be demonstrated by its written records or other reasonable evidence) from a source other than the Disclosing Party or its Agents, which source is not bound by any duty of confidentiality owed, directly or indirectly, to the Disclosing Party in relation to such information;
- 1.4 **Group** means any subsidiary, any holding company and any subsidiary of any holding company of either party; and
- 1.5 **Information** means all information in whatever form including, without limitation, any information relating to systems, operations, plans, intentions, market opportunities, know-how, trade secrets and business affairs whether in writing, conveyed orally or by machine-readable medium.

2 CONFIDENTIAL INFORMATION

- 2.1 All Confidential Information given by one party to this Agreement (the **Disclosing Party**) to the other party (the **Receiving Party**) will be treated by the Receiving Party as secret and confidential and will not, without the Disclosing Party's written consent, directly or indirectly communicate or disclose (whether in writing or orally or in any other manner) Confidential Information to any other person other than in accordance with the terms of this Agreement.
- 2.2 The Receiving Party will only use the Confidential Information for the sole purpose of technical and commercial discussions between the parties in relation to the Bid or for the subsequent performance of any contract between the parties in relation to the Bid.
- 2.3 Notwithstanding clause 2.1 above, the Receiving Party may disclose Confidential Information:
- a) to those of its Agents who strictly need to know the Confidential Information for the sole purpose set out in clause 2.2 above, provided that the Receiving Party shall ensure that such Agents are made aware prior to the disclosure of any part of the Confidential Information that the same is confidential and that they owe a duty of confidence to the Disclosing Party. The Receiving Party shall at all times remain liable for any actions of such Agents that would constitute a breach of this Agreement; or
 - b) to the extent required by law or the rules of any applicable regulatory authority, subject to clause 2.4 below.
- 2.4 In the event that the Receiving Party is required to disclose any Confidential Information in accordance with clause 2.3b) above, it shall promptly notify the Disclosing Party and cooperate with the Disclosing Party regarding the form, nature, content and purpose of such disclosure or any action which the Disclosing Party may reasonably take to challenge the validity of such requirement.
- 2.5 In the event that any Confidential Information shall be copied, disclosed or used otherwise than as permitted under this Agreement then, upon becoming aware of the same, without prejudice to

any rights or remedies of the Disclosing Party, the Receiving Party shall as soon as practicable notify the Disclosing Party of such event and if requested take such steps (including the institution of legal proceedings) as shall be necessary to remedy (if capable of remedy) the default and/or to prevent further unauthorised copying, disclosure or use.

- 2.6 All Confidential Information shall remain the property of the Disclosing Party and its disclosure shall not confer on the Receiving Party any rights, including intellectual property rights over the Confidential Information whatsoever, beyond those contained in this Agreement.

3 RECORDS AND RETURN OF INFORMATION

- 3.1 The Receiving Party agrees to ensure proper and secure storage of all Information and any copies thereof.
- 3.2 The Receiving Party shall keep a written record, to be supplied to the Disclosing Party upon request, of the Confidential Information provided and any copies made thereof and, so far as is reasonably practicable, of the location of such Confidential Information and any copies thereof.
- 3.3 The Company shall, within 7 (seven) days of receipt of a written demand from Transnet:
- a) return all written Confidential Information (including all copies); and
 - b) expunge or destroy any Confidential Information from any computer, word processor or other device whatsoever into which it was copied, read or programmed by the Company or on its behalf.
- 3.4 The Company shall on request supply a certificate signed by a director as to its full compliance with the requirements of clause 3.3b) above.

4 ANNOUNCEMENTS

- 4.1 Neither party will make or permit to be made any announcement or disclosure of its prospective interest in the Bid without the prior written consent of the other party.
- 4.2 Neither party shall make use of the other party's name or any information acquired through its dealings with the other party for publicity or marketing purposes without the prior written consent of the other party.

5 DURATION

The obligations of each party and its Agents under this Agreement shall survive the termination of any discussions or negotiations between the parties regarding the Bid and continue thereafter for a period of 5 (five) years.

6 PRINCIPAL

Each party confirms that it is acting as principal and not as nominee, agent or broker for any other person and that it will be responsible for any costs incurred by it or its advisers in considering or pursuing the Bid and in complying with the terms of this Agreement.

7 ADEQUACY OF DAMAGES

Nothing contained in this Agreement shall be construed as prohibiting the Disclosing Party from pursuing any other remedies available to it, either at law or in equity, for any such threatened or actual breach of this Agreement, including specific performance, recovery of damages or otherwise.

8 PRIVACY AND DATA PROTECTION

8.1 The Receiving Party undertakes to comply with South Africa's general privacy protection in terms of the Bill of Rights (Section 14) in connection with this Bid and shall procure that its personnel shall observe the provisions of such Act (as applicable) or any amendments and re-enactments thereof and any regulations made pursuant thereto.

8.2 The Receiving Party warrants that it and its Agents have the appropriate technical and organisational measures in place against unauthorised or unlawful processing of data relating to the Bid and against accidental loss or destruction of, or damage to such data held or processed by them.

9 GENERAL

9.1 Neither party may assign the benefit of this Agreement, or any interest hereunder, except with the prior written consent of the other, save that Transnet may assign this Agreement at any time to any member of the Transnet Group.

9.2 No failure or delay in exercising any right, power or privilege under this Agreement will operate as a waiver of it, nor will any single or partial exercise of it preclude any further exercise or the exercise of any right, power or privilege under this Agreement or otherwise.

9.3 The provisions of this Agreement shall be severable in the event that any of its provisions are held by a court of competent jurisdiction or other applicable authority to be invalid, void or otherwise unenforceable, and the remaining provisions shall remain enforceable to the fullest extent permitted by law.

9.4 This Agreement may only be modified by a written agreement duly signed by persons authorised on behalf of each party.

9.5 Nothing in this Agreement shall constitute the creation of a partnership, joint venture or agency between the parties.

9.6 This Agreement will be governed by and construed in accordance with South African law and the parties irrevocably submit to the exclusive jurisdiction of the South African courts.

oooOOOooo



GENERAL BID CONDITIONS - SERVICES

[March 2012]

“PREVIEW COPY ONLY”

TABLE OF CONTENTS

1	DEFINITIONS.....	3
2	GENERAL.....	3
3	LODGING OF BID DOCUMENTS	3
4	USE OF BID FORMS.....	3
5	RAISING OF A CHARGE FOR PLANS, SPECIFICATIONS AND BID FORMS	4
6	DEFAULTS BY RESPONDENTS.....	4
7	CURRENCY	5
8	EXCHANGE AND REMITTANCE.....	5
9	ACCEPTANCE OF BID.....	5
10	LAW GOVERNING CONTRACT.....	6
11	IDENTIFICATION	6
12	FORMAL NOTIFICATION REGARDING NAME OF SUCCESSFUL RESPONDENT	6
13	UNAUTHORISED COMMUNICATION ABOUT BIDS.....	6
14	CONTRACT DOCUMENTS	6
15	SECURITIES.....	7
16	PRICES SUBJECT TO CONFIRMATION	7
17	DELETION OF SERVICES EXCLUDED FROM BID	7
18	ALTERATIONS MADE BY THE RESPONDENT TO BID PRICES	7
19	VALUE-ADDED TAX	8
20	TERMS AND CONDITIONS OF BID	8
21	IMPORTANT NOTICE TO RESPONDENTS REGARDING PAYMENT	8
22	PLANS, DRAWINGS, DIAGRAMS, SPECIFICATIONS AND DOCUMENTS	9
23	VISITS TO FOREIGN COUNTRIES	9
24	BIDS BY OR ON BEHALF OF FOREIGN RESPONDENTS.....	9

1 DEFINITIONS

Where the following words or phrases are used in this Agreement, such words or phrases shall have the meaning assigned thereto in this clause, except where the context clearly requires otherwise:

- 1.1 **Bid** or **Bid Document(s)** shall mean a reference to a Request for Proposal or Request for Quotation;
- 1.2 **Respondent(s)** shall mean a respondent/bidder to a Transnet Bid;
- 1.3 **RFP** shall mean Request for Proposal;
- 1.4 **RFQ** shall mean Request for Quotation;
- 1.5 **RFX** shall mean RFP and/or RFQ, as the case may be;
- 1.6 **Services** shall mean the services required by Transnet as specified in its Bid Document;
- 1.7 **Service Provider** shall mean the successful Respondent;
- 1.8 **Tax Invoice** shall mean the document as required by Section 20 of the Value-Added Tax Act, 89 of 1991, as may be amended from time to time;
- 1.9 **Transnet** shall mean Transnet SOC Ltd, a State Owned Company; and
- 1.10 **VAT** shall mean Value-Added Tax chargeable in terms of the Value-Added Tax Act, 89 of 1991, as may be amended from time to time.

2 GENERAL

All Bid Documents and subsequent contracts and orders shall be subject to the following procedures as laid down by Transnet and are to be strictly adhered to by any person or enterprise or company responding to this RFX.

3 LODGING OF BID DOCUMENTS

- 3.1 A Bid, which shall hereinafter include reference to an RFP or RFQ, shall be lodged with Transnet no later than the closing date and time specified for the receipt thereof, in accordance with the directions issued with Bid Documents.
- 3.2 Bids shall be transmitted in a sealed envelope and placed in the tender box at a venue stipulated in the Bid Documents with the Bid number and subject endorsed on the left hand bottom corner of the envelope.
- 3.3 The Respondent's return address must be stated on the reverse side of the sealed envelope.

4 USE OF BID FORMS

- 4.1 Where special forms are issued by Transnet for the submission of Bids, Respondents are required to submit their Bids by completion of the appropriate sections on such official forms and not on office stationery bearing their own terms and conditions of contract; non-compliance with this conditions may result in the rejection of a Bid.
- 4.2 Respondents must note that the original Bid forms must be completed for submission and not a reprocessed facsimile thereof. Only if insufficient space has been allocated to a particular response

may a Respondent submit additional information under separate cover using the Company's letterhead and duly cross-referenced in the RFX.

5 RAISING OF A CHARGE FOR PLANS, SPECIFICATIONS AND BID FORMS

- 5.1 A non-refundable charge may be raised for Bid Documents, depending on the administrative cost of preparing and issuing the Bid Document.
- 5.2 If any of the drawings or specifications referred to in Bid Documents are the official publications of recognised standardising bodies, copies of such drawings and specifications shall be acquired by Respondents at their own expense.

6 DEFAULTS BY RESPONDENTS

- 6.1 If the Respondent, after it has been notified of the acceptance of its Bid fails to:
- enter into a formal contract when called upon to do so in terms of clause 14 [*Contract Documents*], within such period as Transnet may specify; or
 - accept an order in terms of the Bid; or
 - when called upon to do so, furnish satisfactory security of the fulfilment of the contract in terms of clause 15 [*Securities*],

Transnet may, in any such case, without prejudice to any other legal remedy which it may have, proceed to accept any other Bid or, if it is necessary to do so, call for Bids afresh, and may recover from the defaulting Respondent any additional expense incurred by it in calling for new offers or in accepting a higher offer.

- 6.2 If any Respondent, who has submitted a Bid and/or concluded a contract with Transnet [hereinafter referred to as **the Service Provider**], or in the capacity of agent or subcontractor who has been associated with such Bid or contract:
- has withdrawn such Bid after the advertised date and hour for the receipt of Bids; or
 - has, after having been notified of the acceptance of its Bid, failed or refused to sign a contract when called upon to do so in terms of any condition forming part of the Bid Documents; or
 - has carried out any contract resulting from such Bid in an unsatisfactory manner or has breached any condition of such contract; or
 - has offered, promised or given a bribe in relation to the obtaining or the execution of such contract; or
 - has acted in a fraudulent or improper manner or in bad faith towards Transnet or any government department or towards any public body, company or person; or
 - has made any incorrect statement in the affidavit or certificate referred to in clause 12 [*Formal Notification Regarding Name of Successful Respondent*] and is unable to prove to the satisfaction of Transnet that
 - it made the statement in good faith honestly believing it to be correct; and

(ii) before making such statement, it took all reasonable steps to satisfy itself of its correctness; or

g) caused Transnet damage, or to incur costs in order to meet the Service Provider's requirements which could not be recovered from the Service Provider;

then a Bid from any such Respondent shall be disqualified and the person, enterprise or company [including any directors] shall, subject to clause 6.3 below, be disqualified from bidding for any Transnet business through its "blacklisting" process.

6.3 Any person or enterprise or company against whom a decision has been given under the provisions of clauses 6.2b), 6.2d) or 6.2e) above, may make representations to the Chief Operating Officer of Transnet Group, whose decision shall be final.

6.4 Any disqualification [Blacklisting] imposed upon any person or enterprise or company, may also apply to any other enterprise under the same or different names of disqualified persons or enterprise or company [or associates thereof] and shall for avoidance of doubt also be applied to any agent or employee of the person or enterprise or company concerned.

7 CURRENCY

Prices or fees must be quoted in the currency of the Republic of South Africa [ZAR] in respect of local Services. Prices or fees in any other currency may be rejected by Transnet save where such price is quoted by a foreign Respondent.

8 EXCHANGE AND REMITTANCE

The Respondent should note that where the whole or a portion of the contract or order value is to be remitted overseas, Transnet shall, if requested to do so by the Service Provider, effect payment overseas directly to the foreign principal or manufacturer of such percentage of the contract or order value as may be stipulated by the Respondent in its Bid Documents and any variation in the amount to be so paid, which may arise as a result of fluctuations in the rate of exchange involved, will be for the account of the Service Provider.

8.1 The Respondent who desires to avail itself of the aforementioned facility must at the time of bidding furnish the information called for in the clause "Exchange and Remittance" of the Bid Documents and also furnish full details of the principals or service providers to whom payment is to be made.

8.2 The Service Provider shall at its own cost obtain forward exchange cover on foreign currency to protect itself against any currency rate fluctuation risks for the duration of any resulting contract or order. Transnet will NOT accept any fluctuations in the rate of exchange at the time when payments are made.

Transnet will not recognise any claim for adjustment of the order and/or contract price under clause 8.2 above, if the increase in price arises after the date on which the Services were to be completed, as set out in the order and/or contract, or any subsequent agreement between the parties.

9 ACCEPTANCE OF BID

9.1 Transnet does not bind itself to accept the lowest or any Bid.

- 9.2 Transnet reserves the right to accept any Bid in whole or in part.
- 9.3 Upon the acceptance of a Bid by Transnet, the parties shall be bound by these General Bid Conditions and the Standard Terms and Conditions of Contract [Form ST&C – Services] and any schedule of “Special Conditions” or otherwise which form part of the Bid Documents.
- 9.4 Where the Respondent has been informed by Transnet per facsimile message or email of the acceptance of its Bid, the acknowledgement of the receipt transmitted shall be regarded as proof of delivery to the Respondent.

10 LAW GOVERNING CONTRACT

The law of the Republic of South Africa shall govern the contract created by the acceptance of a Bid. The *domicilium citandi et executandi* shall be a place in the Republic of South Africa to be specified by the Respondent in its Bid at which all legal documents may be served on the Respondent who shall agree to submit to the jurisdiction of the courts of the Republic of South Africa. A foreign Respondent shall, therefore, state in its Bid the name of its authorised representative in the Republic of South Africa who is empowered to sign any contract which may be entered into in the event of its Bid being accepted and to act on its behalf in all matters relating to the contract.

11 IDENTIFICATION

If the Respondent is a company, the full names of the directors shall be stated in the Bid. If the Respondent is a close corporation, the full names of the members shall be stated in the Bid. If the Respondent is a partnership or an individual trading under a trade name, the full names of the partners or of such individual, as the case may be, shall be furnished.

12 FORMAL NOTIFICATION REGARDING NAME OF SUCCESSFUL RESPONDENT

In the case of Bids submitted to the Secretary of an Acquisition Council, unsuccessful Respondents will be formally notified of the names of successful Respondent(s) as soon as possible after the closing date for receipt of the Bid in question.

13 UNAUTHORISED COMMUNICATION ABOUT BIDS

Where Bids are submitted to the Secretary of an Acquisition Council, Respondents may at any time communicate with the Secretary on any matter relating to its Bid but, in the absence of written authority from the Secretary, no communication on a question affecting the subject of a Bid shall take place between Respondents or other potential suppliers or any member of the Acquisition Council or official of Transnet during the period between the closing date for the receipt of the Bid and the date of the notification of the successful Respondent(s). A Bid, in respect of which any such unauthorised communication has occurred, may be disqualified.

14 CONTRACT DOCUMENTS

- 14.1 The contract documents will comprise these General Bid Conditions and the Standard Terms and Conditions of Contract [Form ST&C – Services] and any schedule of “Special Conditions” or otherwise which form part of the Bid Documents.

- 14.2 These contract documents will constitute the contract between the parties upon receipt by the Respondent of Transnet's letter of acceptance / intent, subject to all additional amendments and/or special conditions thereto as agreed to by the parties.

15 SECURITIES

- 15.1 The successful Respondent, when called upon to do so, shall provide security to the satisfaction of Transnet for the due fulfilment of a contract or order. Such security shall be in the form of a deed of suretyship [**Deed of Suretyship**] furnished by an approved bank, building society, insurance or guarantee corporation carrying on business in South Africa.
- 15.2 The security may be applied in whole or part at the discretion of Transnet to make good any loss or damage which Transnet may incur in consequence of a breach of the contract or any part thereof.
- 15.3 Such security, if required, shall be an amount which will be stipulated in the Bid Documents.
- 15.4 For the purpose of clause 15.1 above, Transnet will supply a Deed of Suretyship form to the successful Respondent for completion and no guarantee in any other form will be accepted. A copy of such form will be supplied to Respondents on request. For this purpose a Deed of Suretyship form will be provided which shall be completed and returned to Transnet or a designated official by the successful Respondent within 30 [thirty] days from the date of the letter of acceptance. No payment will be made until the form, duly completed, is delivered to Transnet. Failure to return the Deed of Suretyship within the prescribed time shall, save where prior extension has been granted, entitle Transnet without notice to the Service Provider to cancel the contract with immediate effect.
- 15.5 Additional costs incurred by Transnet necessitated by reason of default on the part of the Service Provider in relation to the conditions of this clause 15 will be for the account of the Service Provider.

16 PRICES SUBJECT TO CONFIRMATION

- 16.1 A Bid with prices which are subject to confirmation will not be considered.
- 16.2 Bids where firm prices are quoted for the duration of any resulting order and or contract will receive precedence over prices which are subject to adjustment.

17 DELETION OF SERVICES EXCLUDED FROM BID

The Respondent must delete Services for which it has not tendered or for which the price or fee has been included elsewhere in its Bid.

18 ALTERATIONS MADE BY THE RESPONDENT TO BID PRICES

All alterations made by the Respondent to its Bid price(s) prior to the submission of its Bid Documents must be done by deleting the incorrect figures and words where required and by inserting the correct figures and words against the items/Services concerned. All such alterations must be initialled by the person who signs the Bid Documents. Failure to observe this requirement may result in the particular item(s) or Services concerned being excluded in the matter of the award of the business.

19 VALUE-ADDED TAX

- 19.1 In respect of local Services, i.e. Services to be provided by a South African company, the prices or fees quoted by the Respondent are to be exclusive of VAT which must be shown separately at the standard rate on the Service Provider's Tax Invoice.
- 19.2 In respect of Services to be provided by a foreign principal:
- a) the invoicing by the Service Provider on behalf of its foreign principal represents a service rendered by the principal;
 - b) the Service Provider's Tax Invoice(s) for the local portion only [i.e. the "commission" for the services rendered locally] must show the VAT separately

20 TERMS AND CONDITIONS OF BID

- 20.1 The Service Provider shall adhere to the Standard Terms and Conditions of Contract as set out in Form ST&C - Services, a copy of which is issued with the Bid Documents, together with any schedule of "Special Conditions" or otherwise which form part of the Bid Documents.
- 20.2 Should the Respondent find any conditions unacceptable, it should indicate which conditions are unacceptable and offer alternatives by written submission on a company letterhead. Any such submission shall be subject to review by Transnet's Legal Counsel who shall determine whether the proposed alternative(s) are acceptable or otherwise, as the case may be.

21 IMPORTANT NOTICE TO RESPONDENTS REGARDING PAYMENT

21.1 Method of Payment

- a) The attention of the Respondent is directed to clause 10 [*Invoices and Payment*] of Form ST&C – Services, which sets out the conditions of payment on which Bid price(s) shall be based.
- b) However, in addition to the foregoing the Respondent is invited to submit offers based on alternative methods of payment and/or financing proposals.
- c) The Respondent is required to give full particulars of the terms that will be applicable to its alternative offer(s) and the financial merits thereof will be evaluated and taken into consideration when the Bid is adjudicated.
- d) The Respondent must, therefore, in the first instance, tender strictly in accordance with clause 21.1a) above. Failure to comply with clause 21.1a) above may preclude a Bid from further consideration.

NOTE: The successful Respondent [the **Service Provider**] shall, where applicable, be required to furnish a guarantee covering any advance payments.

21.2 Conditional Discount

Respondents offering prices which are subject to a conditional discount applicable for payment within a specific period are to note that the conditional period will be calculated as from the date of receipt by Transnet of the Service Provider's month-end statement reflecting the relevant Tax Invoice(s) for payment purposes, provided the conditions of the order or contract have been fulfilled and the Tax

Invoice is correct in all respects as referred to in the contract or order. Incomplete and/or incorrect Tax Invoices shall be returned and the conditional period will be recalculated from the date of receipt of the correct documentation.

22 PLANS, DRAWINGS, DIAGRAMS, SPECIFICATIONS AND DOCUMENTS

Copyright in plans, drawings, diagrams, specifications and documents compiled by the Service Provider for the purpose of contract work shall be governed by the terms and conditions detailed in clause 12 of Form ST&T - Services (*Intellectual Property Rights*).

23 VISITS TO FOREIGN COUNTRIES

- 23.1 Respondents must furnish details in a covering letter if it is considered necessary that employees of Transnet should carry out inspection and/or review any operational Services at the premises of the preferred Respondent or its subcontractors overseas for the purpose of a product demonstration and/or final acceptance or for any other reason.
- 23.2 If the Respondent considers overseas visits to be necessary it must provide the following information in a covering letter in respect of each proposed visit:
- countries and places to be visited;
 - number of employees and disciplines involved;
 - number of man-days involved; and
 - motivation for the visit.
- 23.3 Transnet will make all arrangements with regard to booking of air journeys, hotel reservations, transport to and from airports, places of inspection or demonstration, etc. and all expenses will be for the account of Transnet.
- 23.4 Before a visit is undertaken, such as envisaged in this clause 23, Transnet and the Respondent will agree in writing on the number of employees of Transnet that should undertake the visit and the number of man-days involved in the visit.

24 BIDS BY OR ON BEHALF OF FOREIGN RESPONDENTS

- 24.1 Bids submitted by foreign principals may be forwarded direct by the principals to the Secretary of the Acquisition Council or to a designated official of Transnet according to whichever officer is specified in the Bid Documents, or may be so forwarded on the principal's behalf by its South African representative or agent provided that written proof is submitted that such representative or agent has been duly authorised to act in that capacity by the principal. Failure to submit such authorisation by the representative or agent shall disqualify the Bid.
- 24.2 When legally authorised to prepare and submit Bids on behalf of their principals not domiciled in the Republic of South Africa, representatives or agents must compile the Bids in the names of such principals and sign them on behalf of the latter.
- 24.3 South African representatives or agents of a successful foreign Respondent must when so required enter into a formal contract in the name of their principals and must sign such contract on behalf of

the latter. In every such case a legal Power of Attorney from their principals must be furnished to Transnet by the South African representative or agents authorising them to enter into and sign such contract.

- a) Such Power of Attorney must comply with Government Notice No. 1160 of 27 June 1930 [and any amendments thereto] - "Rules of the Supreme Court of South Africa for the authentication of documents executed outside the Republic for use within the Republic."
- b) The Power of Attorney must be signed by the principal under the same title as used in the Bid Documents.
- c) On arrival within the Republic of South Africa this Power of Attorney is to be completed in terms of Section 8(2) of the Stamp Duties Act No. 77 of 1968, or any amendment thereof.
- d) If a Power of Attorney held by the South African representative or agent includes matters of a general nature besides provision for the entering into and signing of a contract with Transnet, a certified copy thereof should be furnished.
- e) The Power of Attorney must authorise the South African representative or agent to choose the *domicilium citandi et executandi* as provided for in clause 26 [Addresses for Notices] of the Standard Conditions of Contract, Form ST&C - Services.

24.4 If payment is to be made in South Africa, the foreign Supplier [i.e. the principal, or its South African agent or representative], must notify Transnet in writing whether, for payment by electronic funds transfer [EFT]:

- a) funds are to be transferred to the credit of the foreign Supplier's account at a bank in South Africa, in which case the name and branch of such bank shall be furnished; or
- b) funds are to be transferred to the credit of its South African agent or representative, in which case the name and branch of such bank shall be furnished.

24.5 The attention of the Respondent is directed to clause 15 above [Securities] regarding the provision of security for the fulfilment of contracts and orders and the manner and form in which such security is to be furnished.

oooOOooo

TRANSNET



**STANDARD TERMS AND CONDITIONS OF CONTRACT
FOR THE PROVISION OF SERVICES TO TRANSNET**

FORM ST&C - SERVICES [March 2012]

“PREVIEW COPY ONLY”

TABLE OF CONTENTS

1 INTRODUCTION.....3

2 DEFINITIONS3

3 INTERPRETATION.....6

4 NATURE AND SCOPE6

5 AUTHORITY OF PARTIES7

6 WARRANTIES7

7 TRANSNET'S OBLIGATIONS9

8 GENERAL OBLIGATIONS OF THE SERVICE PROVIDER.....9

9 FEES AND EXPENSES.....10

10 INVOICING AND PAYMENT11

11 FEE ADJUSTMENTS11

12 INTELLECTUAL PROPERTY RIGHTS12

13 SERVICE PROVIDER'S PERSONNEL.....14

14 LIMITATION OF LIABILITY.....14

15 INSURANCES15

16 CONFIDENTIALITY15

17 TOTAL OR PARTIAL FAILURE TO PERFORM THE SCOPE OF SERVICES.....17

18 TERM AND TERMINATION17

19 CONSEQUENCE OF TERMINATION.....18

20 ASSIGNMENT.....19

21 FORCE MAJEURE.....19

22 EQUALITY AND DIVERSITY19

23 NON-WAIVER20

24 PARTIAL INVALIDITY20

25 DISPUTE RESOLUTION20

26 ADDRESSES FOR NOTICES20

27 WHOLE AND ONLY AGREEMENT.....21

28 AMENDMENT AND CHANGE CONTROL21

29 GOVERNING LAW.....22

30 COUNTERPARTS22

“PREVIEW COPY ONLY”

1 INTRODUCTION

When an Agreement is entered into between Transnet SOC Ltd [**Transnet**] and the appointed supplier of Services to Transnet [**the Service Provider**], these Standard Terms and Conditions of Contract, the technical specifications for the Services, the General Bid Conditions, a Schedule of Requirements or Work Order including such special conditions as may be applicable, and any terms in the associated Bid Documents, exclusively govern the provision of Services by the Service Provider to Transnet.

2 DEFINITIONS

Where the following words or phrases are used in the Agreement, such words or phrases shall have the meaning assigned thereto in this clause, except where the context clearly requires otherwise:

- 2.1 **AFSA** means the Arbitration Foundation of South Africa;
- 2.2 **Agreement** means the Agreement and its associated schedules and/or annexures and/or appendices, including the Work Order(s), specifications for the Services and such special conditions as shall apply to the Agreement, together with the General Tender Conditions and any additional provisions in the associated bid documents tendered by the Service Provider [as agreed in writing between the Parties], which collectively and exclusively govern the provision of Services by the Service Provider to Transnet;
- 2.3 **Background Intellectual Property** means all Intellectual Property introduced and required by either Party to give effect to their obligations under the Agreement owned in whole or in part by or licensed to either Party or their affiliates prior to the Commencement Date or developed after the Commencement Date otherwise pursuant to the Agreement;
- 2.4 **Business Day(s)** means Mondays to Fridays between 07:30 and 16:00, excluding public holidays as proclaimed in South Africa;
- 2.5 **Commencement Date** means [●], notwithstanding the signature date of the Agreement;
- 2.6 **Confidential Information** means any information or other data, whether in written, oral, graphic or in any other form such as in documents, papers, memoranda, correspondence, notebooks, reports, drawings, diagrams, discs, articles, samples, test results, prototypes, designs, plans, formulae, patents, or inventor's certificates, which a Party discloses or provides to the other Party [intentionally or unintentionally, or as a result of one Party permitting the representative of the other Party to visit any of its premises], or which otherwise becomes known to a Party, and which is not in the public domain and includes, without limiting the generality of the term:
 - a) information relating to methods of operation, data and plans of the disclosing Party;
 - b) the contents of the Agreement;
 - c) private and personal details of employees or clients of the disclosing Party or any other person where an onus rests on the disclosing Party to maintain the confidentiality of such information;
 - d) any information disclosed by either Party and which is clearly marked as being confidential or secret;
 - e) information relating to the strategic objectives and planning of the disclosing Party relating to its existing and planned future business activities;

- f) information relating to the past, present and future research and development of the disclosing Party;
- g) information relating to the business activities, business relationships, products, services, customers, clients and Subcontractors of the disclosing Party where an onus rests on the disclosing Party to maintain the confidentiality of such information;
- h) information contained in the software and associated material and documentation belonging to the disclosing Party;
- i) technical and scientific information, Know-How and trade secrets of a disclosing Party including inventions, applications and processes;
- j) Copyright works;
- k) commercial, financial and marketing information;
- l) data concerning architecture, demonstrations, tools and techniques, processes, machinery and equipment of the disclosing Party;
- m) plans, designs, concepts, drawings, functional and technical requirements and specifications of the disclosing Party;
- n) information concerning faults or defects in goods, equipment, hardware or software or the incidence of such faults or defects; and
- o) information concerning the charges, Fees and / or costs of the disclosing Party or its authorised Subcontractors, or their methods, practices or service performance levels actually achieved;

2.7 **Copyright** means the right in expressions, procedures, methods of operations or mathematical concepts, computer program codes, compilations of data or other material, literary works, musical works, artistic works, sound recordings, broadcasts, program carrying signals, published editions, photographic works, or cinematographic works of the copyright owner to do or to authorise the doing of certain acts specified in respect of the different categories of works;

2.8 **Default** means any breach of the obligations of either Party [including but not limited to fundamental breach or breach of a fundamental term] or any Default, act, omission, negligence or statement of either Party, its employees, agents or Subcontractors in connection with or in relation to the subject of the Agreement and in respect of which such Party is liable to the other;

2.9 **Deliverable(s)** means any and all works of authorship, products and materials developed, written, prepared, assembled, integrated, modified or provided by the Service Provider in relation to the Services;

2.10 **Designs** mean registered Designs and/or Design applications and will include the monopoly right granted for the protection of an independently created industrial design including designs dictated essentially by technical or functional considerations as well as topographies of integrated circuits and integrated circuits;

2.11 **Fee(s)** shall mean the agreed Fees for the Services to be purchased from the Service Provider by Transnet, as detailed in the Work Order(s), issued in accordance with the Agreement, as amended by mutual agreement between the Parties and in accordance with the provisions of the Agreement from time to time;

- 2.12 **Foreground Intellectual Property** means all Intellectual Property developed by either Party pursuant to the Agreement;
- 2.13 **Intellectual Property** means Patents, Designs, Know-How, Copyright and Trade Marks and all rights having equivalent or similar effect which may exist anywhere in the world and includes all future additions and improvements to the Intellectual Property;
- 2.14 **Know-How** means all Confidential Information of whatever nature relating to the Intellectual Property and its exploitation as well as all other Confidential Information generally relating to Transnet's field of technology, including technical information, processing or manufacturing techniques, Designs, specifications, formulae, systems, processes, information concerning materials and marketing and business information in general;
- 2.15 **Materials** means the Deliverables, the Service Provider Materials and the Third Party Materials;
- 2.16 **Parties** mean the Parties to the Agreement together with their subsidiaries, divisions, business units, successors-in-title and their assigns;
- 2.17 **Party** means either one of these Parties;
- 2.18 Patents mean registered Patents and Patent applications, once the latter have proceeded to grant, and includes a right granted for any inventions, products or processes in all fields of technology;
- 2.19 **Permitted Purpose** means any activity or process to be undertaken or supervised by Personnel or employees of one Party during the term of the Agreement, for which purpose authorised disclosure of the other Party's Confidential Information or Intellectual Property is a prerequisite in order to enable such activity or process to be accomplished;
- 2.20 **Personnel** means any partner, employee, agent, consultant, independent associate or supplier, Subcontractor and the staff of such Subcontractor, or other authorised representative of either Party;
- 2.21 **Purchase Order(s)** means official orders issued by an operating division of Transnet to the Service Provider for the provision of Services;
- 2.22 **Service(s)** means [●], the Service(s) provided to Transnet by the Service Provider, pursuant to the Work Order(s) in terms of the Agreement;
- 2.23 **Service Level Agreement or SLA** means the processes, deliverables, key performance indicators and performance standards relating to the Services to be provided by the Service Provider;
- 2.24 **Subcontract** means any contract or agreement or proposed contract or agreement between the Service Provider and any third party whereby that third party agrees to provide to the Service Provider the Services or any part thereof;
- 2.25 **Subcontractor** means the third party with whom the Service Provider enters into a Subcontract;
- 2.26 **Service Provider Materials** means all works of authorship, products and materials [including, but not limited to, data, diagrams, charts, reports, specifications, studies, inventions, software, software development tools, methodologies, ideas, methods, processes, concepts and techniques] owned by, or licensed to, the Service Provider prior to the Commencement Date or independently developed by the Service Provider outside the scope of the Agreement at no expense to Transnet, and used by the Service Provider in the performance of the Services;

- 2.27 **Tax Invoice** means the document as required by Section 20 of the Value-Added Tax Act, 89 of 1991, as may be amended from time to time;
- 2.28 **Third Party Material** means software, software development tools, methodologies, ideas, methods, processes, concepts and techniques owned by, or licensed to a third party and used by the Service Provider in the performance of the Services;
- 2.29 **Trade Marks** mean registered Trade Marks and trade mark applications and includes any sign or logo, or combination of signs and/or logos capable of distinguishing the goods or services of one undertaking from those of another undertaking;
- 2.30 **VAT** means Value-Added Tax chargeable in terms of the Value-Added Tax Act, 89 of 1991, as may be amended from time to time; and
- 2.31 **Work Order(s)** means a detailed scope of work for a Service required by Transnet, including timeframes, Deliverable, Fees and costs for the supply of the Service to Transnet, which may be appended to the Agreement from time to time.

3 INTERPRETATION

- 3.1 Clause headings in the Agreement are included for ease of reference only and do not form part of the Agreement for the purposes of interpretation or for any other purpose. No provision shall be construed against or interpreted to the disadvantage of either Party hereto by reason of such Party having or being deemed to have structured or drafted such provision.
- 3.2 Any term, word, acronym or phrase used in the Agreement, other than those defined under the clause heading "Definitions" shall be given its plain English meaning, and those terms, words, acronyms, and phrases used in the Agreement will be interpreted in accordance with the generally accepted meanings accorded thereto.
- 3.3 A reference to the singular incorporates a reference to the plural and *vice versa*.
- 3.4 A reference to natural persons incorporates a reference to legal persons and *vice versa*.
- 3.5 A reference to a particular gender incorporates a reference to the other gender.

4 NATURE AND SCOPE

- 4.1 The Agreement is an agreement under the terms and conditions of which the Service Provider will arrange for the provision to Transnet of the Services which meet the requirements of Transnet, the delivery of which Services is controlled by means of Purchase Orders to be issued by Transnet and executed by the Service Provider, in accordance with the Agreement.
- 4.2 Such Purchase Orders shall be agreed between the Parties from time to time, subject to the terms of the relevant Work Order(s).
- 4.3 Each properly executed Purchase Order forms an inseparable part of the Agreement as if it were fully incorporated into the body of the Agreement.
- 4.4 During the period of the Agreement, both Parties can make written suggestions for amendments to the Work Order(s), in accordance with procedures set out in clause 28 [*Amendment and Change Control*] below. A Party will advise the other Party within 14 [fourteen] Business Days, or such other period as mutually agreed, whether the amendment is acceptable.
- 4.5 Insofar as any term, provision or condition in the Work Order(s) conflicts with a like term, provision or condition in the Agreement and/or a Purchase Order, or where the Agreement is

silent on the matter, the term, provision or condition in this Master Agreement shall prevail, unless such term or provision or condition in this Master Agreement has been specifically revoked or amended by mutual written agreement between the Parties.

- 4.6 Time will be of the essence and the Service Provider will perform its obligations under the Agreement in accordance with the timeframe(s) [if any] set out in the relevant schedule, save that the Service Provider will not be liable under this clause if it is unable to meet such obligation within the time required as a direct result of any act or omission by Transnet and it has used its best endeavours to advise Transnet of such act or omission. In the event of such delay, any time deadlines detailed in the relevant schedule shall be extended by a period equal to the period of that delay.

5 AUTHORITY OF PARTIES

- 5.1 Nothing in the Agreement will constitute or be deemed to constitute a partnership between the Parties, or constitute or be deemed to constitute the Parties as agents or employees of one another for any purpose or in any form whatsoever.
- 5.2 Neither Party shall be entitled to, or have the power or authority to enter into an agreement in the name of the other; or give any warranty, representation or undertaking on the other's behalf; or create any liability against the other or bind the other's credit in any way or for any purpose whatsoever.

6 WARRANTIES

- 6.1 The Service Provider warrants to Transnet that:
- a) it has full capacity and authority to enter into and to perform the Agreement and that the Agreement is executed by a duly authorised representatives of the Service Provider;
 - b) it will discharge its obligations under the Agreement and any annexure, appendix or schedule hereto with all due skill, care and diligence;
 - c) it will be solely responsible for the payment of remuneration and associated benefits, if any, of its Personnel and for withholding and remitting income tax for its Personnel in conformance with any applicable laws and regulations;
 - d) it will procure licences for Transnet in respect of all Third Party Material detailed in the Work Order(s), and will procure the right for Transnet to take such copies [in whole or in part] of such Third Party Materials as it may reasonably require for the purposes of back-up for archiving and disaster recovery; and
 - e) the use or possession by Transnet of any Materials will not subject Transnet to any claim for infringement of any Intellectual Property Rights of any third party.
- 6.2 The Service Provider warrants that it will perform its obligations under the Agreement in accordance with the Service Levels as defined in the relevant schedule. Transnet may at its discretion audit compliance with the Service Levels, provided that any such audit is carried out with reasonable prior notice and in a reasonable way so as not to have an adverse effect on the performance of the Services. Without prejudice to clause 6.3 below, in the event that the Service Provider fails to meet the Service Levels, Transnet may claim appropriate service credits or invoke a retention of Fees as detailed in the relevant schedule and/or Work Order.

- 6.3 The Service Provider warrants that for a period of 90 [ninety] days from Acceptance of the Deliverables they will, if properly used, conform in all material respects with the requirements set out in the relevant schedule. The Service Provider will at its expense remedy any such non-conformance as soon as possible but in any event within 30 [thirty] days of notification by Transnet. In the event that the Service Provider fails or is unable to remedy such non-conformance within such time-scale, Transnet will be entitled to employ a third party to do so in place of the Service Provider and any excess charges or costs incurred by Transnet as a result shall be paid by the Service Provider.
- 6.4 The Service Provider will remedy any defect within 30 [thirty] days of being notified of that defect by Transnet in writing.
- 6.5 The Service Provider will not be liable to remedy any problem arising from or caused by any modification made by Transnet to the Deliverables, or any part thereof, without the prior approval of the Service Provider.
- 6.6 The Service Provider shall advise Transnet of the effects of any steps proposed by Transnet pursuant to clause 6.5 above, including but not limited to any cost implications or any disruption or delay in the performance of the Services. The Parties agree that any changes to the Services, including the charges for the Services or any timetables for delivery of the Services, will be agreed in accordance with the change control procedure, as set out in clause 28 [Amendment and Change Control].
- 6.7 The Service Provider warrants that:
- a) it has, using the most up-to-date software available, tested for [and deleted] all commonly known viruses in the Materials and for all viruses known by the Service Provider at the date of the relevant Work Order; and
 - b) at the time of delivery to Transnet, the Materials do not contain any trojan horse, worm, logic bomb, time bomb, back door, trap door, keys or other harmful components.
- The Service Provider agrees that, in the event that a virus is found, it will at its own expense use its best endeavours to assist Transnet in reducing the effect of the virus and, particularly in the event that a virus causes loss of operational efficiency or loss of data, to assist Transnet to the same extent to mitigate such losses and to restore Transnet to its original operating efficiency.
- 6.8 The Service Provider undertakes to comply with South Africa's general privacy protection in terms of the Bill of Rights [Section 14] in connection with the Agreement and shall procure that its Personnel shall observe the provisions of Section 14 [as applicable] or any amendments and re-enactments thereof and any regulations made pursuant thereto.
- 6.9 The Service Provider warrants that it has taken all reasonable precautions to ensure that, in the event of a disaster, the impact of such disaster on the ability of the Service Provider to comply with its obligations under the Agreement will be reduced to the greatest extent possible, and that the Service Provider shall ensure that it has appropriate, tested and documented recovery arrangements in place.
- 6.10 In compliance with the National Railway Safety Regulator Act, 16 of 2002, the Service Provider shall ensure that the Services, to be supplied to Transnet under the terms and conditions of the Agreement, comply fully with the specifications as set forth in Schedule 1 hereto, and shall thereby adhere [as applicable] to railway safety requirements and/or regulations. Permission for

the engagement of a Subcontractor by the Service Provider [as applicable] shall be subject to a review of the capability of the proposed Subcontractor to comply with the specified railway safety requirements and/or regulations. The Service Provider and/or its Subcontractor shall grant Transnet access, during the term of the Agreement, to review any safety-related activities, including the coordination of such activities across all parts of its organisation.

7 TRANSNET'S OBLIGATIONS

- 7.1 Transnet undertakes to promptly comply with any reasonable request by the Service Provider for information, including information concerning Transnet's operations and activities, that relates to the Services as may be necessary for the Service Provider to perform the Services, but for no other purpose. However, Transnet's compliance with any request for information is subject to any internal security rules and requirements and subject to the observance by the Service Provider of its confidentiality obligations under the Agreement.
- 7.2 The Service Provider shall give Transnet reasonable notice of any information it requires in accordance with clause 7.1 above.
- 7.3 Subject to clause 13 [*Service Provider's Personnel*], Transnet agrees to provide the Service Provider or its Personnel such access to and use of its facilities as is necessary to allow the Service Provider to perform its obligations under the Agreement.

8 GENERAL OBLIGATIONS OF THE SERVICE PROVIDER

- 8.1 The Service Provider shall:
- a) respond promptly to all complaints and enquiries from Transnet;
 - b) inform Transnet immediately of any dispute or complaint arising in relation to the provision of the Services;
 - c) conduct its business in a professional manner that will reflect positively upon the Service Provider and the Service Provider's Services;
 - d) keep full records clearly indicating all transactions concluded by the Service Provider relating to the performance of the Services and keep such records for at least 5 [five] years from the date of each such transaction;
 - e) obtain, and at all times maintain in full force and effect, any and all licences, permits and the like required under applicable laws for the provision of the Services and the conduct of the business and activities of the Service Provider;
 - f) observe and ensure compliance with all requirements and obligations as set out in the labour and related legislation of South Africa, including the Occupational Health and Safety Act, 85 of 1993;
 - g) comply with all applicable environmental legislation and regulations, and demonstrate sound environmental policies, management and performance; and
 - h) ensure the validity of all renewable certifications, including but not limited to its Tax Clearance Certificate and B-BBEE Accreditation Certificate, for the duration of the Agreement. Should the Service Provider fail to present Transnet with such renewals as they become due, Transnet shall be entitled, in addition to any other rights and remedies that it may have in terms of the Agreement, to terminate the Agreement forthwith without any

liability and without prejudice to any claims which Transnet may have for damages against the Service Provider.

8.2 The Service Provider acknowledges and agrees that it shall at all times:

- a) render the Services and perform all its duties with honesty and integrity;
- b) communicate openly and honestly with Transnet and demonstrate a commitment to performing the Services timeously, efficiently and to the required standards;
- c) endeavour to provide the highest possible standards of service and professionalism, with a reasonable degree of care and diligence;
- d) use its best endeavours and make every diligent effort to meet agreed deadlines;
- e) treat its own Personnel, as well as all Transnet's officers, employees, agents and consultants, with fairness and courtesy and respect for their human rights;
- f) practice and promote its own internal policies aimed at prohibiting and preventing unfair discrimination [as further referred to in clause 22 – *Equality and Diversity*];
- g) treat all enquiries from Transnet in connection with the Services with courtesy and respond to all enquiries promptly and efficiently. Where the Service Provider is unable to comply with the provisions of this clause, the Service Provider will advise Transnet of the delay and the reasons therefor and will keep Transnet informed of progress made regarding the enquiry;
- h) when requested by Transnet, provide clear and accurate information regarding the Service Provider's own policies and procedures, excluding Know-How and other Confidential Information, except where a non-disclosure undertaking has been entered into between the Parties;
- i) not allow a conflict of interest to develop between its own interests [or the interests of any of its other customers] and the interests of Transnet;
- j) not accept or offer, nor allow, induce or promote the acceptance or offering of any gratuity, enticement, incentive or gift that could reasonably be regarded as bribery or an attempt to otherwise exert undue influence over the recipient;
- k) not mislead Transnet or its officers, employees and stakeholders, whether by act or omission;
- l) not otherwise act in an unethical manner or do anything which could reasonably be expected to damage or tarnish Transnet's reputation or business image; and
- m) immediately report to Transnet any unethical, fraudulent or otherwise unlawful conduct of which it becomes aware in connection with Transnet or the provision of Services.

9 FEES AND EXPENSES

- 9.1 In consideration of the provision of the Services, Transnet will pay to the Service Provider the Fees detailed in the relevant schedule or Work Order.
- 9.2 Transnet will not be invoiced for materials used in the provision of the Services save for those materials [if any] set out in the Work Order and accepted by Transnet or in any relevant Work Order [which will be invoiced to Transnet at cost].

- 9.3 Unless otherwise agreed in a schedule or Work Order, Transnet will reimburse to the Service Provider all reasonable and proper expenses incurred directly and solely in connection with the provision of the Services, provided that all such expenses:
- a) are agreed by Transnet in advance;
 - b) are incurred in accordance with Transnet's standard travel and expenses policies;
 - c) are passed on to Transnet at cost with no administration fee; and
 - d) will only be reimbursed if supported by relevant receipts.
- 9.4 All Tax Invoices relating to Fees, out of pocket expenses and, if applicable, travel and accommodation costs, will provide the detail for each of the Personnel carrying out the Services and incurring the expenses, and the Tax Invoice will, where appropriate, include VAT as a separate item.

10 INVOICING AND PAYMENT

- 10.1 Transnet shall pay the Service Provider the amounts stipulated in the relevant schedule or Work Order, subject to the terms and conditions of the Agreement.
- 10.2 Transnet shall pay such amounts to the Service Provider, upon receipt of a correct and undisputed Tax Invoice together with the supporting documentation as specified in the Work Order appended hereto, once the undisputed Tax Invoices, or such portion of the Tax Invoices which are undisputed become due and payable to the Service Provider for the provision of the Services, in terms of clause 10.4 below.
- 10.3 All Fees and other sums payable under the Agreement are exclusive of VAT, which will be payable at the applicable rate.
- 10.4 Unless otherwise provided for in the Work Order(s) appended to the Agreement, Tax Invoices shall be submitted together with a month-end statement. Payment against such month-end statement shall be made by Transnet within 30 [thirty] days after date of receipt by Transnet of the statement together with all undisputed Tax Invoices and supporting documentation.
- 10.5 Where the payment of any Tax Invoice, or any part thereof which is not in dispute, is not made in accordance with this clause 10, the Service Provider shall be entitled to charge interest on the outstanding amount, at The Standard Bank of South Africa's prime rate of interest in force, for the period from the due date of payment until the outstanding amount is paid.

11 FEE ADJUSTMENTS

- 11.1 Fees for Services rendered in terms of the Agreement shall be subject to review as indicated in the Work Order(s) annexed hereto from time to time.
- 11.2 No less than 2 [two] months prior to any proposed Fee adjustment, the Parties shall commence negotiations for Fees for the next period or as otherwise indicated and appended hereto.
- 11.3 Should Transnet and the Service Provider fail to reach an agreement on Fees for the successive period, either Party shall be entitled to submit this matter to dispute resolution in accordance with clause 25 of this Master Agreement [*Dispute Resolution*].

12 INTELLECTUAL PROPERTY RIGHTS

12.1 Title to Confidential Information

- a) Transnet will retain all right, title and interest in and to its Confidential Information and Background Intellectual Property and the Service Provider acknowledges that it has no claim of any nature in and to the Confidential Information and Background Intellectual Property that is proprietary to Transnet. For the avoidance of doubt, all the Service Provider's Background Intellectual Property shall remain vested in the Service Provider.
- b) Transnet shall grant to the Service Provider an irrevocable, royalty free, non-exclusive licence to use Transnet's Background Intellectual Property only for the Permitted Purpose. This license shall not permit the Service Provider to sub-license to other parties.
- c) The Service Provider shall grant to Transnet an irrevocable, royalty free, non-exclusive licence to use the Service Provider's Background Intellectual Property for the Permitted Purpose. This licence shall not permit Transnet to sub-license to other parties.
- d) The Service Provider shall grant Transnet access to the Service Provider's Background Intellectual Property on terms which shall be *bona fide* negotiated between the Parties for the purpose of commercially exploiting the Foreground Intellectual Property, to the extent that such access is required.

12.2 Title to Intellectual Property

- a) All right, title and interest in and to Foreground Intellectual Property prepared, conceived or developed by the Service Provider, its researchers, agents and employees shall vest in Transnet and the Service Provider acknowledges that it has no claim of any nature in and to the Foreground Intellectual Property. The Service Provider shall not at any time during or after the termination or cancellation of the Agreement dispute the validity or enforceability of such Foreground Intellectual Property, or cause to be done any act or anything contesting or in any way impairing or tending to impair any part of that right, title and interest to any of the Foreground Intellectual Property and shall not counsel or assist any person to do so.
- b) Transnet shall be entitled to seek protection in respect of the Foreground Intellectual Property anywhere in the world as it shall decide in its own absolute discretion and the Service Provider shall reasonably assist Transnet in attaining and maintaining protection of the Foreground Intellectual Property.
- c) Where the Foreground Intellectual Property was created by the Service Provider or its researchers, agents and employees and where Transnet elects not to exercise its option to seek protection or decides to discontinue the financial support of the prosecution or maintenance of any such protection, Transnet shall notify the Service Provider who shall have the right of first refusal to file or continue prosecution or maintain any such applications and to maintain any protection issuing on the Foreground Intellectual Property.
- d) No consideration shall be paid by Transnet to the Service Provider for the assignment of any Foreground Intellectual Property from the Service Provider to Transnet, over and above the sums payable in terms of the Agreement. The Service Provider undertakes to

sign all documents and do all things as may be necessary to effect, record and perfect the assignment of the Foreground Intellectual Property to Transnet.

- e) Subject to anything contrary contained in the Agreement and/or the prior written consent of Transnet [which consent shall not be unreasonably withheld or delayed], the Service Provider shall under no circumstances be entitled as of right, or to claim the right, to use Transnet's Background Intellectual Property and/or Foreground Intellectual Property.

12.3 Title to Improvements

Any improvements, developments, adaptations and/or modifications to the Foreground Intellectual Property, and any and all new inventions or discoveries, based on or resulting from the use of Transnet's Background Intellectual Property and/or Confidential Information shall be exclusively owned by Transnet. The Service Provider shall disclose promptly to Transnet all such improvements, developments, adaptations and/or modifications, inventions or discoveries. The Service Provider hereby undertakes to sign all documents and do all things as may be necessary to effect, record and perfect the assignment of such improvements, developments, adaptations and/or modifications, inventions or discoveries to Transnet and the Service Provider shall reasonably assist Transnet in attaining, maintaining or documenting ownership and/or protection of the improved Foreground Intellectual Property.

12.4 Unauthorised Use of Confidential Information

The Service Provider shall not authorise any party to act on or use in any way any Confidential Information belonging to Transnet whether or not such party is aware of such Confidential Information, and shall promptly notify Transnet of the information if it becomes aware of any party so acting, and shall provide Transnet the information with such assistance as Transnet reasonably requires, at Transnet's cost and expense, to prevent such third party from so acting.

12.5 Unauthorised Use of Intellectual Property

- a) The Service Provider agrees to notify Transnet in writing of any conflicting uses of, and applications or registrations of Patents, Designs and Trade Marks or any act of infringement, unfair competition or passing off involving the Intellectual Property of Transnet of which the Service Provider acquires knowledge and Transnet shall have the right, as its own option, to proceed against any party infringing its Intellectual Property.
- b) It shall be within the sole and absolute discretion of Transnet to determine what steps shall be taken against the infringer and the Service Provider shall co-operate fully with Transnet, at Transnet's cost, in whatever measure including legal action to bring any infringement of illegal use to an end.
- c) The Service Provider shall cooperate to provide Transnet promptly with all relevant ascertainable facts.
- d) If proceedings are commenced by Transnet alone, Transnet shall be responsible for all expenses but shall be entitled to all damages or other award arising out of such proceedings. If proceedings are commenced by both Parties, both Parties will be responsible for the expenses and both Parties shall be entitled to damages or other award arising out of proceedings.

13 SERVICE PROVIDER'S PERSONNEL

- 13.1 The Service Provider's Personnel shall be regarded at all times as employees, agents or Subcontractors of the Service Provider and no relationship of employer and employee shall arise between Transnet and any Service Provider Personnel under any circumstances regardless of the degree of supervision that may be exercised over the Personnel by Transnet.
- 13.2 The Service Provider warrants that all its Personnel will be entitled to work in South Africa or any other country in which the Services are to be performed.
- 13.3 The Service Provider will ensure that its Personnel comply with all reasonable requirements made known to the Service Provider by Transnet concerning conduct at any Transnet premises or any other premises upon which the Services are to be performed [including but not limited to security regulations, policy standards and codes of practice and health and safety requirements]. The Service Provider will ensure that such Personnel at all times act in a lawful and proper manner in accordance with these requirements.
- 13.4 Transnet reserves the right to refuse to admit or to remove from any premises occupied by or on behalf of it, any Service Provider Personnel whose admission or presence would, in the reasonable opinion of Transnet, be undesirable or who represents a threat to confidentiality or security or whose presence would be in breach of any rules and regulations governing Transnet's Personnel, provided that Transnet notifies the Service Provider of any such refusal [with reasons why]. The reasonable exclusion of any such individual from such premises shall not relieve the Service Provider from the performance of its obligations under the Agreement.
- 13.5 The Service Provider agrees to use all reasonable endeavours to ensure the continuity of its Personnel assigned to perform the Services. If any re-assignment by the Service Provider of those Personnel is necessary, or if Transnet advises that any such Personnel assigned are in any respect unsatisfactory, including where any such Personnel are, or are expected to be or have been absent for any period, then the Service Provider will promptly supply a replacement of equivalent calibre and experience, and any such replacement shall be approved by Transnet prior to commencing provision of the Services, such approval not to be unreasonably withheld or delayed.

14 LIMITATION OF LIABILITY

- 14.1 Neither Party excludes or limits liability to the other Party for:
- a) death or personal injury due to negligence; or
 - b) fraud.
- 14.2 The Service Provider shall indemnify and keep Transnet indemnified from and against liability for damage to any Transnet property [whether tangible or intangible] or any other loss, costs or damage suffered by Transnet to the extent that it results from any act of or omission by the Service Provider or its Personnel in connection with the Agreement. The Service Provider's liability arising out of this clause 14.2 shall be limited to a maximum amount payable in respect of any one occurrence or a series of related occurrences in a single calendar year, such amount to be agreed in writing by the Parties.
- 14.3 Subject always to clauses 14.1 and 14.2 above, the liability of either the Service Provider or Transnet under or in connection with the Agreement, whether for negligence, misrepresentation, breach of contract or otherwise, for direct loss or damage arising out of each Default or series of

related Defaults shall not exceed 100% [one hundred per cent] of the Fees paid under the schedule or Work Order to which the Default(s) relates.

- 14.4 Subject to clause 14.1 above, and except as provided in clauses 14.2 and 14.3 above, in no event shall either Party be liable to the other for indirect or consequential loss or damage or including indirect or consequential loss of profits, business, revenue, goodwill or anticipated savings of an indirect nature or loss or damage incurred by the other Party as a result of third party claims.
- 14.5 If for any reason the exclusion of liability in clause 14.4 above is void or unenforceable, either Party's total liability for all loss or damage under the Agreement shall be as provided in clause 14.3 above.
- 14.6 Nothing in this clause 14 shall be taken as limiting the liability of the Service Provider in respect of clause 12 [*Intellectual Property Rights*] or clause 16 [*Confidentiality*].

15 INSURANCES

- 15.1 Without limiting the liability of the Service Provider under the Agreement, the Service Provider shall take out insurance in respect of all risks for which it is prudent for the Service Provider to insure against, including any liability it may have as a result of its activities under the Agreement for theft, destruction, death or injury to any person and damage to property. The level of insurance will be kept under review by Transnet, on an annual basis, to ensure its adequacy, provided that any variation to the level of such insurance shall be entirely at the discretion of the Service Provider.
- 15.2 The Service Provider shall arrange insurance with reputable insurers and will produce to Transnet evidence of the existence of the policies on an annual basis within 30 [thirty] days after date of policy renewals.

16 CONFIDENTIALITY

- 16.1 The Parties hereby undertake the following, with regard to Confidential Information:
- a) not to divulge or disclose to any person whomsoever in any form or manner whatsoever, either directly or indirectly, any Confidential Information of the other, without the prior written consent of such other Party, other than when called upon to do so in accordance with a statute, or by a court having jurisdiction, or by any other duly authorised and empowered authority or official, in which event the Party concerned shall do what is reasonably possible to inform the other of such a demand and each shall assist the other in seeking appropriate relief or the instituting of a defensive action to protect the Confidential Information concerned;
 - b) not to use, exploit, permit the use of, directly or indirectly, or in any other manner whatsoever apply the Confidential Information, disclosed to it as a result of the Agreement, for any purpose whatsoever other than for the purpose for which it is disclosed or otherwise than in strict compliance with the provisions in the Agreement;
 - c) not to make any notes, sketches, drawings, photographs or copies of any kind of any part of the disclosed Confidential Information, without the prior written consent of such other Party, except when reasonably necessary for the purpose of the Agreement, in which case such copies shall be regarded as Confidential Information;

- d) not to de-compile, disassemble or reverse engineer any composition, compilation, concept application, item, component de-compilation, including software or hardware disclosed and shall not analyse any sample provided by Transnet, or otherwise determine the composition or structure or cause to permit these tasks to be carried out except in the performance of its obligations pursuant to the Agreement;
- e) not to exercise less care to safeguard Transnet Confidential Information than the Party exercises in safeguarding its own competitive, sensitive or Confidential Information;
- f) Confidential Information disclosed by either Party to the other or by either Party to any other party used by such Party in the performance of the Agreement, shall be dealt with as "restricted" or shall be dealt with according to any other appropriate level of confidentiality relevant to the nature of the information concerned, agreed between the Parties concerned and stipulated in writing for such information in such cases;
- g) the Parties shall not make or permit to be made by any other person subject to their control, any public statements or issue press releases or disclose Confidential Information with regard to any matter related to the Agreement, unless written authorisation to do so has first been obtained from the Party first disclosing such information;
- h) each Party shall be entitled to disclose such aspects of Confidential Information as may be relevant to one or more technically qualified employees or consultants of the Party who are required in the course of their duties to receive the Confidential Information for the Permitted Purpose provided that the employee or consultant concerned has a legitimate interest therein, and then only to the extent necessary for the Permitted Purpose, and is informed by the Party of the confidential nature of the Confidential Information and the obligations of the confidentiality to which such disclosure is subject and the Party shall ensure such employees or consultants honour such obligations;
- i) each Party shall notify the other Party of the name of each person or entity to whom any Confidential Information has been disclosed as soon as practicable after such disclosure;
- j) each Party shall ensure that any person or entity to which it discloses Confidential Information shall observe and perform all of the covenants the Party has accepted in the Agreement as if such person or entity has signed the Agreement. The Party disclosing the Confidential Information shall be responsible for any breach of the provisions of the Agreement by the person or entity; and
- k) each Party may by written notice to the other Party specify which of the Party's employees, officers or agents are required to sign a non-disclosure undertaking.

16.2 The duties and obligations with regard to Confidential Information in this clause 16 shall not apply where:

- a) a Party can demonstrate that such information is already in the public domain or becomes available to the public through no breach of the Agreement by that Party, or its Personnel; or
- b) was rightfully in a Party's possession prior to receipt from the other Party, as proven by the first-mentioned Party's written records, without an infringement of an obligation or duty of confidentiality; or

- c) can be proved to have been rightfully received by a Party from a third party without a breach of a duty or obligation of confidentiality; or
- d) is independently developed by a Party as proven by its written records.

16.3 This clause 16 shall survive termination for any reason of the Agreement and shall remain in force and effect from the Commencement Date of the Agreement and 5 [five] years after the termination of the Agreement. Upon termination of the Agreement, all documentation furnished to the Service Provider by Transnet pursuant to the Agreement shall be returned to Transnet including, without limitation all corporate identity equipment including dies, blocks, labels, advertising matter, printing matter and the like.

17 TOTAL OR PARTIAL FAILURE TO PERFORM THE SCOPE OF SERVICES

Should the Service Provider fail or neglect to execute the work or to deliver any portion of the Service, as required by the terms of the Agreement or Work Order, Transnet may cancel the Agreement or Work Order in so far as it relates to the unexecuted work or rejected portion of the Service, and, in such event, the provision of any remaining commitment shall remain subject in all respects to these conditions.

18 TERM AND TERMINATION

18.1 Notwithstanding the date of signature hereof, the Commencement Date if the Agreement is [●] and the duration shall be for a 12 [twelve] month period, expiring on [●], unless:

- a) the Agreement is terminated by either Party in accordance with the provisions incorporated herein or in any schedules or annexures appended hereto, or otherwise in accordance with law or equity; or
- b) the Agreement is extended at Transnet's option for a further period to be agreed by the Parties.

18.2 Either Party may terminate the Agreement forthwith by notice in writing to the other Party where the other Party has committed a material Default and, where such Default is capable of remedy, has failed to remedy such Default within 30 [thirty] days of receiving notice specifying the Default and requiring its remedy.

18.3 Either Party may terminate the Agreement forthwith by notice in writing to the other Party when the other Party is unable to pay its debts as they fall due or commits any act or omission which would be an act of insolvency in terms of the Insolvency Act, 24 of 1936 [as may be amended from time to time], or if any action, application or proceeding is made with regard to it for:

- a) a voluntary arrangement or composition or reconstruction of its debts;
- b) its winding-up or dissolution;
- c) the appointment of a liquidator, trustee, receiver, administrative receiver or similar officer; or
- d) any similar action, application or proceeding in any jurisdiction to which it is subject.

18.4 Transnet may terminate the Agreement at any time within 2 [two] months of becoming aware of a change of control of the Service Provider by notice in writing to the Service Provider. For the purposes of this clause, "control" means the right to direct the affairs of a company whether by ownership of shares, membership of the board of directors, agreement or otherwise.

- 18.5 Transnet may cancel any schedule or Work Order hereto at any time on giving the Service Provider 30 [thirty] days' written notice.
- 18.6 Notwithstanding this clause 18, either Party may cancel the Agreement without cause by giving 30 [thirty] days prior written notice thereof to the other Party.

19 CONSEQUENCE OF TERMINATION

- 19.1 Termination in accordance with clause 18 [*Term and Termination*] shall not prejudice or affect any right of action or remedy which shall have accrued or shall thereafter accrue to either Party and all provisions which are to survive the Agreement or impliedly do so shall remain in force and in effect.
- 19.2 On termination of the Agreement or a Work Order, the Service Provider will immediately deliver up, and procure that its Personnel will immediately deliver up to Transnet, all Deliverables and property belonging to Transnet [or, in the event of termination of a Work Order, such as is relevant to that Work Order] which may be in the possession of, or under the control of the Service Provider, and certify to Transnet in writing that this has been done.
- 19.3 To the extent that any of the Deliverables and property referred to in clause 19.2 above are in electronic form and contained on non-detachable storage devices, the Service Provider will provide Transnet with unencrypted copies of the same on magnetic media and will irretrievably destroy and delete copies so held.
- 19.4 In the event that the Agreement is terminated by the Service Provider under clause 18.2 [*Term and Termination*], or in the event that a Work Order is terminated by Transnet under clause 18.5 [*Term and Termination*], Transnet will pay to the Service Provider all outstanding Fees [apportioned on a *pro rata* basis] relating to the work undertaken by the Service Provider up until the date of such termination. Transnet will also pay the costs of any goods and materials ordered by the Service Provider in relation to the such work for which the Service Provider has paid or is legally obliged to pay, in which case, on delivery of such goods or materials, the Service Provider will promptly deliver such goods and materials to Transnet or as it may direct.
- 19.5 The provisions of clauses 0 [*Definitions*], 6 [*Warranties*], 12 [*Intellectual Property Rights*], 14 [*Limitation of Liability*], 16 [*Confidentiality*], 19 [*Consequence of Termination*], 25 [*Dispute Resolution*] and 29 [*Governing Law*] shall survive termination or expiry of the Agreement.
- 19.6 If either Party [**the Defaulting Party**] commits a material breach of the Agreement and fails to remedy such breach within 30 [thirty] Business Days of written notice thereof, the other Party [hereinafter **the Aggrieved Party**], shall be entitled, in addition to any other rights and remedies that it may have in terms of the Agreement, to terminate the Agreement forthwith without any liability and without prejudice to any claims which the Aggrieved Party may have for damages against the Defaulting Party.
- 19.7 Should:
- a) the Service Provider effect or attempt to effect a compromise or composition with its creditors; or
 - b) either Party be provisionally or finally liquidated or placed under judicial management, whether provisionally or finally; or

- c) either Party cease or threaten to cease to carry on its normal line of business or default or threaten to default in the payment of its liabilities generally, or commit any act or omission which would be an act of insolvency in terms of the Insolvency Act, 24 of 1936 [as may be amended from time to time];

then the other Party shall be entitled, but not obliged, to terminate the Agreement on written notice, in which event such termination shall be without any liability and without prejudice to any claims which either Party may have for damages against the other.

20 ASSIGNMENT

Neither Party may assign the benefit of the Agreement or any interest hereunder except with the prior written consent of the other. Further, in the event that Transnet wishes to assign or novate the Agreement to any third party, the Service Provider agrees that it shall not unreasonably withhold or delay its consent to such assignment or novation and that it shall only be entitled to recover from Transnet any reasonable legal costs incurred by it as a direct result of such assignment or novation.

21 FORCE MAJEURE

21.1 Neither Party shall have any claim against the other Party arising from any failure or delay in the performance of any obligation of either Party under the Agreement caused by an act of *force majeure* such as acts of God, fire, flood, war, strike, lockout, industrial dispute, government action, laws or regulations, riots, terrorism or civil disturbance, defaults, delays or discontinuance on the part of independent contractors, suppliers, or other circumstances or factors beyond the reasonable control of either Party, and to the extent that the performance of obligations of either Party hereunder is delayed by virtue of the foregoing, any period stipulated for any such performance shall be reasonably extended.

21.2 Each Party will take all reasonable steps by whatever lawful means that are available, to resume full performance as soon as practicable and will seek agreement to modification of the relevant provisions of the Agreement in order to accommodate the new circumstances caused by the act of *force majeure*. If a Party fails to agree to such modifications proposed by the other Party within 90 [ninety] days of the act of *force majeure* first occurring, either Party may thereafter terminate the Agreement with immediate notice.

22 EQUALITY AND DIVERSITY

22.1 The Service Provider will not victimise, harass or discriminate against any employee of either Party to the Agreement or any applicant for employment with either Party to the Agreement due to their gender, race, disability, age, religious belief, sexual orientation or part-time status. This provision applies, but is not limited to employment, upgrading, work environment, demotion, transfer, recruitment, recruitment advertising, termination of employment, rates of pay or other forms of compensation and selection for training.

22.2 Both Parties to the Agreement undertake that they will not, and shall procure that its employees, agents and Subcontractors will not breach any applicable discrimination legislation and any amendments and re-enactments thereof.

23 NON-WAIVER

- 23.1 Failure or neglect by either Party, at any time, to enforce any of the provisions of the Agreement, shall not, in any manner, be construed to be a waiver of any of that Party's rights in that regard and in terms of the Agreement.
- 23.2 Such failure or neglect shall not, in any manner, affect the continued, unaltered validity of the Agreement, or prejudice the right of that Party to institute subsequent action.

24 PARTIAL INVALIDITY

If any provision of the Agreement shall be held to be invalid, illegal or unenforceable, or shall be required to be modified, the validity, legality and enforceability of the remaining provisions shall not be affected thereby.

25 DISPUTE RESOLUTION

- 25.1 Should any dispute of whatsoever nature arise between the Parties concerning the Agreement, the Parties shall try to resolve the dispute by negotiation within 10 [ten] Business Days of such dispute arising.
- 25.2 If the dispute has not been resolved by such negotiation, either of the Parties may refer the dispute to AFSA and notify the other Party accordingly, which proceedings shall be held in Johannesburg.
- 25.3 Such dispute shall be finally resolved in accordance with the rules of AFSA by an arbitrator or arbitrators appointed by AFSA.
- 25.4 This clause constitutes an irrevocable consent by the Parties to any proceedings in terms hereof, and neither of the Parties shall be entitled to withdraw from the provisions of this clause or claim at any such proceedings that it is not bound by this clause 25.
- 25.5 This clause 25 is severable from the rest of the Agreement and shall remain in effect even if the Agreement is terminated for any reason.
- 25.6 This clause 25 shall not preclude either Party from seeking urgent relief in a court of appropriate jurisdiction, where grounds for urgency exist.

26 ADDRESSES FOR NOTICES

26.1 The Parties to the Agreement select the physical addresses and facsimile numbers, as detailed hereafter, as their respective addresses for giving or sending any notice provided for or required in terms of the Agreement, provided that either Party shall be entitled to substitute such other address or facsimile number, as may be, by written notice to the other:

a) **Transnet**

(i) For legal notices: [●]

Fax No. [●]

Attention: Legal Department

- (ii) For commercial notices: [●]
Fax No. [●]
Attention: [●]

b) **The Service Provider**

- (i) For legal notices: [●]
Fax No. [●]
Attention: [●]

- (ii) For commercial notices: [●]
Fax No. [●]
Attention: [●]

26.2 Any notice shall be addressed to a Party at its physical address or delivered by hand, or sent by facsimile.

26.3 Any notice shall be deemed to have been given:

- a) if hand delivered, on the day of delivery; or
b) if posted by prepaid registered post, 10 [ten] days after the date of posting thereof; or
c) if faxed, on the date and time of sending of such fax, as evidenced by a fax confirmation printout, provided that such notice shall be confirmed by prepaid registered post on the date of dispatch of such fax, or, should no postal facilities be available on that date, on the next Business Day.

27 WHOLE AND ONLY AGREEMENT

27.1 The Parties hereby confirm that the Agreement constitutes the whole and only agreement between them with regard to the subject matter of the Agreement.

27.2 The Parties hereby confirm that the Agreement replaces all other agreements which exist or may have existed in any form whatever between them, with regard to the subject matter dealt with in the Agreement, including any annexures, appendices, schedules or Work Order(s) appended hereto.

28 AMENDMENT AND CHANGE CONTROL

28.1 Any requirement for an amendment or change to the Agreement or to a Work Order shall only be valid if it is in writing, signed by both Parties and added to the Agreement as an addendum hereto.

28.2 In the event the Parties cannot agree upon changes, the Parties shall in good faith seek to agree any proposed changes using the dispute resolution procedures in clause 25 [Dispute Resolution].

29 GOVERNING LAW

The Agreement is exclusively governed by and construed in accordance with the laws of the Republic of South Africa and is subject to the jurisdiction of the courts of the Republic of South Africa.

29.1 Change of Law

In the Agreement, unless the context otherwise requires, references to a statutory provision include references to that statutory provision as from time to time amended, extended or re-enacted and any regulations made under it, provided that in the event that the amendment, extension or re-enactment of any statutory provision or introduction of any new statutory provision has a material impact on the obligations of either Party, the Parties will negotiate in good faith to agree such amendments to the Agreement as may be appropriate in the circumstances. If, within a reasonable period of time, the Service Provider and Transnet cannot reach agreement on the nature of the changes required or on modification of Fees, Deliverables, warranties, or other terms and conditions, either Party may seek to have the matter determined in accordance with clause 25 [*Dispute Resolution*] above.

30 COUNTERPARTS

The Agreement may be signed in any number of counterparts, all of which taken together shall constitute one and the same instrument. Either Party may enter into the Agreement by signing any such counterpart.

oooOOOooo

“PREVIEW COPY ONLY”