



**TRANSNET FREIGHT RAIL**, a division of

**TRANSNET SOC LTD**

Registration Number 1990/000900/30

[hereinafter referred to as **Transnet**]

**REQUEST FOR QUOTATION [RFQ] No BEX/52489**

**FOR THE SUPPLY, INSTALL, TEST AND COMMISSIONING OF DC CONTROL PANELS  
AT HEUNINGSPRUIT, JORDAAN, BOSRAND AND GLEN TRACTION TIE STATIONS**

**ISSUE DATE : 12 SEPTEMBER 2013**

**CLOSING DATE : 1 OCTOBER 2013**

**CLOSING TIME : 10:00**

**FORMAL BRIEFING : 20 SEPTEMBER AT 10:00 - A COMPULSORY PRE-  
QUOTATION SITE MEETING AND/OR BRIEFING SESSION  
WILL BE CONDUCTED AT GLEN TRACTION TIE STATION**

**Section 1**  
**NOTICE TO BIDDERS**

Quotations which must be completed as indicated in Section 2 of this RFQ are to be submitted as follows:

Quotations which must be completed as indicated in Section 2 of this RFQ are to be submitted as follows:

**METHOD:** Courier

**CLOSING VENUE:** Supply Chain Services  
Admin Support  
Tender Box  
Office No. 2  
Real Estate Management Building  
Austen Street  
Beaconsfield  
Kimberley  
(Contact person: Maggie Pain Tel. 053-838 3341)

**1 Responses to RFQ**

Responses to this RFQ [**Quotations**] must not include documents or reference relating to any other quotation or proposal. Any additional conditions must be embodied in an accompanying letter.

**2 Broad-Based Black Economic Empowerment [B-BBEE]**

Transnet fully endorses and supports the Government's Broad-Based Black Economic Empowerment Programme and it would therefore prefer to do business with local business enterprises who share these same values. Transnet will accordingly allow a "preference" to companies who provide a valid B-BBEE Verification Certificate. All procurement transactions will be evaluated accordingly.

**2.1 B-BBEE Scorecard and Rating**

As prescribed in terms of the Preferential Procurement Policy Framework Act (PPPFA), Act 5 of 2000 and its Regulations, Respondents are to note the following:

- Proposals will be evaluated on price which will be allocated 80 or 90 points and preference which will be allocated 20 or 10 points, dependent on the value of the Services.
- The 80/20 preference point system applies where the acquisition of the Services will be less than R1 000 000.00. However, if the 80/20 preference point system is stipulated in this RFQ and all Bids received exceed R1 000 000.00, the RFQ will be cancelled.
- The 90/10 preference point system applies where acquisition of the Services will exceed R1 000 000.00. However, if the 90/10 preference point system is stipulated in this RFQ and all Bids received are equal to or below R1 000 000.00, the RFQ will be cancelled.
- In this RFQ, Transnet will apply **90/10** preference point system prescribed in the PPPFA.

In compliance with the Government Gazette No 34612, Notice No. 754 dated 23 September 2011, as from 1 October 2011 valid B-BBEE Verification Certificates must be issued by:

- (i) Verification Agencies accredited by the South African National Accreditation System [SANAS]; or
- (ii) Registered Auditors approved by the Independent Regulatory Board of Auditors [IRBA], in accordance with the approval granted by the Department of Trade and Industry.

Enterprises will be rated by such agencies based on the following:

**a) Large Enterprises [i.e. annual turnover greater than R35 million]:**

- Rating level based on all seven elements of the B-BBEE scorecard

**b) Qualifying Small Enterprises – QSE [i.e. annual turnover between R5 million and R35 million]:**

- Rating based on any four of the elements of the B-BBEE scorecard

**c) Exempted Micro Enterprises – EME [i.e. annual turnover less than R5 million]:**

In accordance with B-BBEE Codes of Good Practice [Statement 000, Section 4], any enterprise with an annual total revenue of R 5 million or less qualifies as an EME.

- Automatic rating of B-BBEE Level 4 irrespective of race or ownership
- Black ownership greater than 50% or Black Women ownership greater than 50% automatically qualify as B-BBEE Level 3

Sufficient evidence to qualify as an EME would be a certificate (which may be in the form of a letter) from an auditor or accounting officer or a certificate from a Verification Agency accredited by SANAS. The certificate must confirm the company's turnover, black ownership / black female ownership, B-BBEE status level and validity date.

*Respondents are required to furnish proof of the above to Transnet. [i.e. a valid detailed scorecard as stipulated above in respect of Large Enterprises and QSEs, or a valid certificate in respect of EMEs].*

Transnet will accordingly allocate a maximum of **10 [ten] points** to the Respondent's final score based on an entity's B-BBEE scorecard rating.

N.B. Failure to submit a B-BBEE certificate, which is valid as at the Closing Date of this RFP, will result in a score of zero being allocated for B-BBEE.

### 3 Communication

Respondents are warned that a response will be liable for disqualification should any attempt be made by a Respondent either directly or indirectly to canvass any officer(s) or employee of Transnet in respect of this RFQ between the closing date and the date of the award of the business.

A Respondent may, however, before the closing date and time, direct any written enquiries relating to the RFQ to the following Transnet employee:

Name: Gideon Joubert  
 Email: [Gideon.Joubert@Transnet.net](mailto:Gideon.Joubert@Transnet.net)

Respondents may also, at any time after the closing date of the RFQ, communicate with Supply Chain Services, Admin Support on any matter relating to its RFQ response:

Telephone 053 838 3341  
Email Maggie.Pain@Transnet.net

#### 4 Tax Clearance

The Respondent's original valid Tax Clearance Certificate must accompany the Quotation. Failure to provide this document with the RFQ submission will result in disqualification.

#### 5 VAT Registration

The valid VAT registration number must be stated here: \_\_\_\_\_ [if applicable].

#### 6 Legal Compliance

The successful Respondent shall be in full and complete compliance with any and all applicable national and local laws and regulations.

#### 7 Changes to Quotations

Changes by the Respondent to its submission will not be considered after the closing date and time.

#### 8 Pricing

All prices must be quoted in South African Rand on a fixed price basis, excluding VAT.

#### 9 Prices Subject to Confirmation

Prices quoted which are subject to confirmation will not be considered.

#### 10 Negotiations

Transnet reserves the right to undertake post-tender negotiations with selected Respondents or any number of short-listed Respondents.

#### 11 Binding Offer

Any Quotation furnished pursuant to this Request shall be deemed to be an offer. Any exceptions to this statement must be clearly and specifically indicated.

#### 12 Disclaimers

Transnet is not committed to any course of action as a result of its issuance of this RFQ and/or its receipt of a Quotation in response to it. Please note that Transnet reserves the right to:

- modify the RFQ's goods / service(s) and request Respondents to re-bid on any changes;
- reject any Quotation which does not conform to instructions and specifications which are detailed herein;
- disqualify Quotations submitted after the stated submission deadline;
- not necessarily accept the lowest priced Quotation;
- reject all Quotations, if it so decides;
- place an order in connection with this Quotation at any time after the RFQ's closing date;

- award only a portion of the proposed goods / service/s which are reflected in the scope of this RFQ;
- split the award of the order/s between more than one Supplier/Service Provider; or
- make no award at all.

In addition, Transnet reserves the right to exclude any Respondent from the bidding process who has been convicted of a serious breach of law during the preceding 5 [five] years, including but not limited to breaches of the Competition Act 89 of 1998. Respondents are required to indicate below whether or not they have been found guilty of a serious breach of law during the past 5 [five] years:

I/We \_\_\_\_\_ do hereby certify that *I/we have/have not been* found guilty during the preceding 5 [five] years of a serious breach of law, including but not limited to a breach of the Competition Act, 89 of 1998, by a court of law, tribunal or other administrative body. The type of breach that the Respondent is required to disclose excludes relatively minor offences or misdemeanours, e.g. traffic offences.

Where found guilty of such a serious breach, please disclose:

NATURE OF BREACH:

\_\_\_\_\_

DATE OF BREACH: \_\_\_\_\_

Furthermore, I/we acknowledge that Transnet SOC Ltd reserves the right to exclude any Respondent from the bidding process, should that person or entity have been found guilty of a serious breach of law, tribunal or regulatory obligation.

### 13 Evaluation Criteria

Transnet will utilise the following criteria [not necessarily in this order] in choosing a Supplier/Service Provider, if so required:

- **Administrative responsiveness** - Completeness of response and returnable documents
- **Substantive responsiveness** – Prequalification criteria, if any, must be met and whether the Bid materially complies with the scope and/or specification given
- Weighted evaluation based on 90/10 preference point system as indicated in paragraph 2:
  - Pricing and price basis [firm] - whilst not the sole factor for consideration, competitive pricing and overall level of unconditional discounts<sup>1</sup> will be critical
  - B-BBEE status of company

Preference points will be awarded to a bidder for attaining the B-BBEE status level of contribution in accordance with the table below:

<sup>1</sup> Only unconditional discounts will be taken into account during evaluation. A discount which has been offered conditionally will, despite not being taken into account for evaluation purposes, be implemented when payment is effected.

B-BBEE Status Level of Contributor	Number of points (90/10 system)
1	10
2	9
3	8
4	5
5	4
6	3
7	2
8	1
Non-compliant contributor	0

**14 Validity Period**

Transnet desires a validity period of 90 [ninety] days from the closing date of this RFQ.  
 This RFQ is valid until \_\_\_\_\_.

**15 Banking Details**

BANK: \_\_\_\_\_  
 BRANCH NAME / CODE: \_\_\_\_\_  
 ACCOUNT HOLDER: \_\_\_\_\_  
 ACCOUNT NUMBER: \_\_\_\_\_

**16 Company Registration**

Registration number of company / C.C. \_\_\_\_\_  
 Registered name of company / C.C. \_\_\_\_\_

**17 Disclosure of Prices Quoted**

Respondents must indicate here whether Transnet may disclose their quoted prices and conditions to other Respondents:

YES  NO

**18 Returnable Documents**

**Returnable Documents** means all the documents, Sections and Annexures, as listed in the tables below.

a) Respondents are required to submit with their Quotations the **mandatory Returnable Documents**, as detailed below.

***Failure to provide all these Returnable Documents at the Closing Date and time of this RFQ will result in a Respondent's disqualification. Respondents are therefore urged to ensure that all these Documents are returned with their Quotations.***

All Sections, as indicated in the footer of each page, must be signed, stamped and dated by the Respondent. Please confirm submission of these mandatory Returnable Documents by so indicating [Yes or No] in the table below:

Mandatory Returnable Documents	Submitted [Yes or No]
SECTION 2 : Quotation Form	
- Original valid Tax Clearance Certificate [Consortia / Joint Ventures must submit a separate Tax Clearance Certificate for each party]	
ANNEXURE A : Contractual Obligations	
Form E.4E Transnet (Jan 2004) Safety arrangements and Procedural compliance with the Occupational Health and Safety act (Act 85 of 1993 and applicable regulations	
E7/1 (July 1998) Specification for general work and works on, over, under or adjacent to Railway lines and near high voltage equipment Special conditions	

- b) In addition to the requirements of section (a) above, Respondents are further required to submit with their Quotations the following **essential Returnable Documents** as detailed below.

***Failure to provide all these Returnable Documents may result in a Respondent's disqualification. Respondents are therefore urged to ensure that all these documents are returned with their Quotations.***

All Sections, as indicated in the footer of each page, must be signed, stamped and dated by the Respondent. Please confirm submission of these essential Returnable Documents by so indicating [Yes or No] in the table below:

Essential Returnable Documents	Submitted [Yes or No]
SECTION 1 : Notice to Bidders	
- Valid B-BBEE Verification Certificate [RSA Large Enterprises and QSEs] Note: failure to provide a valid B-BBEE Verification Certificate at the closing date and time of the tender will result in an automatic score of zero being allocated for B-BBEE scorecard	
- Valid B-BBEE certificate from auditor, accounting officer or SANAS accredited Verification Agency [RSA EMEs] Note: failure to provide a valid B-BBEE Verification Certificate at the closing date and time of the tender will result in an automatic score of zero being allocated for B-BBEE scorecard	
- In the case of Joint Ventures, a copy of the Joint Venture Agreement or written confirmation of the intention to enter into a Joint Venture Agreement	
- SECTION 3 : Standard Terms and Conditions of Contract for the Supply of Services to Transnet	
SECTION 4 : Vendor Application Form	
- Original cancelled cheque or bank verification of banking details	
- Certified copies of IDs of shareholder/directors/members [as applicable]	
- Certified copy of Certificate of Incorporation [CM29/CM9 name change]	
- Certified copy of share certificates [CK1/CK2 if C.C.]	
- Entity's letterhead	
- Certified copy of VAT Registration Certificate [RSA entities only]	

Essential Returnable Documents	Submitted [Yes or No]
- Certified copy of valid Company Registration Certificate [if applicable]	
- A signed letter from Respondent's auditor or accountant confirming most recent annual turnover figures	

- c) In addition to the requirements of paragraph a) and b) above, Respondents are further requested to submit with their Proposals the following **additional documents** as detailed below.

Please confirm submission of these additional documents by so indicating [Yes or No] in the table below:

ADDITIONAL DOCUMENTS	SUBMITTED [Yes or No]
Letter of Good Standing	

"PREVIEW COPY ONLY"



## Section 2 QUOTATION FORM

I/We \_\_\_\_\_  
hereby offer to supply the goods/services at the prices quoted in the Price Schedule below, in accordance with the conditions related thereto.

I/We agree to be bound by those terms and conditions in:

- the Standard Terms and Conditions for the Supply of Goods or Services to Transnet [Section 3 hereof]; and
- any other standard or special conditions mentioned and/or embodied in this Request for Quotation.

I/We accept that unless Transnet should otherwise decide and so inform me/us, this Quotation [and, if any, its covering letter and any subsequent exchange of correspondence], together with Transnet's acceptance thereof shall constitute a binding contract between Transnet and me/us.

I/We further agree that if, after I/we have been notified of the acceptance of my/our Quotation, I/we fail to deliver the said goods/service/s within the delivery lead-time quoted, Transnet may, without prejudice to any other legal remedy which it may have, cancel the order and recover from me/us any expenses incurred by Transnet in calling for Quotations afresh and/or having to accept any less favourable offer.

### Price Schedule

I/We quote as follows for the service required, on a "delivered nominated destination" basis, excluding VAT:

Item	Description	Unit	Qty	Rate	Price
<b>A</b>	<b>Heuningspruit Tie Station</b>				
1	Supply and install AC/DC Distribution Panel Complete with 400V Socket outlet for calibration	ea	1		
2	Supply and install controlling cables complete	sum	1		
3	Supply and install indoor earthing complete	sum	2		
4	Supply and install DC earth leakage Relay	ea	1		
5	Supply and install telecontrol multicore cable	sum	1		
16	P's & G's	sum	1		
17	Installation, Testing and Pre-commissioning	sum	1		
18	Security	sum	1		
<b>A</b>	<b>Total Price for Heuningspruit Tie Station(Excl. VAT)</b>			<b>R</b>	

Respondent's Signature

Date & Company Stamp

Item	Description	Unit	Qty	Rate	Price
<b>B</b>	<b>Jordaan Tie Station</b>				
1	Supply and install AC/DC Distribution Panel Complete with 400V Socket outlet for calibration	ea	1		
2	Supply and install controlling cables complete	sum	1		
3	Supply and install indoor earthing complete	sum	2		
4	Supply and install DC earth leakage Relay	ea	1		
5	Supply and install telecontrol multicore cable	sum	1		
16	P's & G's	sum	1		
17	Installation, Testing and Pre-commissioning	sum	1		
18	Security	sum	1		
<b>B</b>	<b>Total Price for Jordaan Tie Station(Excl. VAT)</b>			<b>R</b>	

Item	Description	Unit	Qty	Rate	Price
<b>C</b>	<b>Bosrand Tie Station</b>				
1	Supply and install AC/DC Distribution Panel Complete with 400V Socket outlet for calibration	ea	1		
2	Supply and install controlling cables complete	sum	1		
3	Supply and install indoor earthing complete	sum	2		
4	Supply and install DC earth leakage Relay	ea	1		
5	Supply and install telecontrol multicore cable	sum	1		
16	P's & G's	sum	1		
17	Installation, Testing and Pre-commissioning	sum	1		
18	Security	sum	1		
<b>C</b>	<b>Total Price for Bosrand Tie Station(Excl. VAT)</b>			<b>R</b>	

Respondent's Signature

Date &amp; Company Stamp

Item	Description	U	Q	Rate	Price
<b>D</b>	<b>Glen Tie Station</b>				
1	Supply and install AC/DC Distribution Panel Complete with 400V Socket outlet for calibration	ea	1		
2	Supply and install controlling cables complete	sum	1		
3	Supply and install indoor earthing complete	sum	2		
4	Supply and install DC earth leakage Relay	ea	1		
5	Supply and install telecontrol multicore cable	sum	1		
16	P's & G's	sum	1		
17	Installation, Testing and Pre-commissioning	sum	1		
18	Security	sum	1		
<b>D</b>	<b>Total Price for Glen Tie Station(Excl. VAT)</b>			<b>R</b>	
<b>E</b>	<b>Total Price for (A + B + C + D) (Excl. VAT)</b>			<b>R</b>	

**Delivery Lead-Time from date of purchase order :** \_\_\_\_\_ [days/weeks]

**Notes to Pricing:**

- All Prices must be quoted in South African Rand, exclusive of VAT
- To facilitate like-for-like comparison bidders must submit pricing strictly in accordance with this price schedule and not utilise a different format. Deviation from this pricing schedule could result in a bid being disqualified.
- Please note that should you have offered a discounted price(s), Transnet will only consider such price discount(s) in the final evaluation stage if offered on an unconditional basis.

### Section 3

#### STANDARD TERMS AND CONDITIONS FOR THE SUPPLY OF GOODS OR SERVICES TO TRANSNET

A Supplier/Service Provider shall be obliged to adhere to the Standard Terms and Conditions for the Supply of Goods and Services to Transnet as expressed hereunder. Should the Respondent find any condition(s) unacceptable, it should indicate which condition(s) is/are unacceptable and offer an alternative(s). A Quotation submitted by a Respondent will be subjected to review and acceptance or rejection of its proposed contractual terms and conditions by Transnet's Legal Counsel, prior to consideration for an award of business.

#### 1 SOLE AGREEMENT

Unless otherwise agreed in writing, these terms [Terms and each Term] and Transnet's purchase order(s) [Order or Orders] represent the only conditions upon which Transnet SOC Ltd [Transnet] procures goods [the Goods] or services [the Services] specified in the Order from the person to whom the Order is addressed [the Supplier/Service Provider]. Transnet does not accept any other conditions which the Supplier/Service Provider may specify, unless otherwise agreed to by Transnet in writing. In the event of any inconsistency between these Terms and any Order, these Terms shall take precedence.

#### 2 CONFORMITY WITH ORDER

Goods/Services shall conform strictly with the Order. The Supplier/Service Provider shall not vary the quantities specified and/or the specification, if any, stipulated in the Order, without the prior written consent of Transnet. The Supplier/Service Provider warrants that the Goods/Services shall be fit for their purpose and of satisfactory quality.

#### 3 DELIVERY AND TITLE

3.1 The delivery dates and addresses are those in the Order. Time shall be of the essence in respect of the Supplier's/Service Provider's obligations under the Order.

3.2 The Supplier/Service Provider will not be excused for delay in delivery or performance except due to circumstances outside its control and then only subject to the Supplier/Service Provider having notified Transnet in writing on becoming aware of such circumstances. Transnet may terminate an Order, in whole or in part, without incurring any liability to the Supplier/Service Provider if such a delay becomes, in Transnet's absolute opinion, significant.

3.3 If on delivery, the Goods/Services do not conform to the Order, Transnet may reject the Goods/Services and the Supplier/Service Provider shall promptly rectify any defects or in Transnet's opinion, supply appropriate replacement Goods/Services at the Supplier's/Service Provider's expense within the specified delivery times, without any liability due by Transnet.

#### 4 PRICE AND PAYMENT

4.1 Prices specified in an Order cannot be increased. Payment for the Goods/Services shall be made by Transnet against an original undisputed invoice(s) [a Tax Invoice], supporting documentation and month-end statement from the Supplier/Service Provider. Tax Invoices plus supporting documentation shall be posted to the address shown in the Order.

4.2 Payment of the Supplier's/Service Provider's valid Tax Invoice(s) will be made by Transnet in the South African currency and on the terms stated in the Order, the standard payment terms being 30 [thirty] days from date of receipt by Transnet of a month-end statement, unless otherwise agreed to in writing. Transnet shall arrange for payment of such Tax Invoices and any pre-authorized additional expenses incurred, provided that the authorised expenses are supported by acceptable documentary proof of expenditure incurred [where this is available]. Any amounts due in terms of these Terms shall be paid to the Supplier/Service Provider, taking into account any deduction or set-off and bank charges.

## 5 PROPRIETARY RIGHTS LIABILITY

If any allegations should be made or any claim asserted against Transnet that ownership of, or any act or omission by Transnet in relation to Goods/Services or any written material provided to Transnet relating to any Goods/Services or pursuant to an Order being a violation or infringement of any third party's contractual, industrial, commercial or intellectual property rights including but not limited to any patent, registered design, design right, trade mark, copyright or service mark on any application thereof, the Supplier/Service Provider hereby indemnifies Transnet against and hold it harmless from any and all losses, liabilities, costs, claims, damages and expenses [including any legal fees] arising directly or indirectly from such allegation or claim provided that this indemnity shall not apply where the allegation or claim arises solely as a result of the Supplier/Service Provider following a design or process originated and furnished by Transnet. The Supplier/Service Provider shall either

- a) procure for Transnet the right to continue using the infringing Goods; or
- b) modify or replace the Goods/Services so that they become non-infringing,

provided that in both cases the Goods/Services shall continue to meet Transnet's requirements and any specifications stipulated in the Order. Should neither option be possible, the Supplier/Service Provider may remove, with Transnet's prior written consent, such Goods/Services and will pay to Transnet a sum equivalent to the purchase price. If Transnet refuses to give such consent, the Supplier/Service Provider shall have no liability in respect of any continued use of the infringing Goods/Services after Supplier's/Service Provider's prior written request to remove the same.

## 6 PROPRIETARY INFORMATION

All information which Transnet has divulged or may divulge to the Supplier/Service Provider and any information relating to Transnet's business which may have come into the Supplier's/Service Provider's possession whilst carrying out an Order, and the existence of the Order, shall be treated by the Supplier/Service Provider as confidential information and shall not, without Transnet's prior written consent, be disclosed to any third party, or be used or copied for any purposes other than to perform the Order. This clause does not apply to information which is public knowledge or available from other sources other than by breach of this Term. Upon request by Transnet, the Supplier/Service Provider shall return all materials issued pursuant to the Order and, pending this, shall protect Transnet's rights in any such materials. Such confidential information shall at all material times be the property of Transnet.

**7 PUBLICITY**

The Supplier/Service Provider shall not name Transnet or use its trademarks, service marks [whether registered or not] or Goods in connection with any publicity without Transnet's prior written consent.

**8 TERMINATION OF ORDER**

- 8.1 Transnet may cancel an Order in whole or in part at any time upon at least 7 [seven] days' written notice to the Supplier/Service Provider, or when there is a change in control of the Supplier/Service Provider or the Supplier/Service Provider commits any serious breach or any repeated or continued material breach of its obligations under these Terms and/or Order or shall have been guilty of conduct tending to bring itself into disrepute, on written notice to the Supplier/Service Provider when such work on the Order shall stop.
- 8.2 Transnet shall pay the Supplier/Service Provider a fair and reasonable price for justified work in progress, where such price reflects only those costs not otherwise recoverable by the Supplier/Service Provider, at the time of termination, and the Supplier/Service Provider shall give Transnet full assistance to check the extent of such work in progress. Payment of such price shall be in full and final satisfaction of any claims arising out of such termination and upon such payment the Supplier/Service Provider shall deliver to Transnet all work, including any materials, completed or in progress. The sum payable to the Supplier/Service Provider under this clause will not in any event exceed the total amount that would have been payable to the Supplier/Service Provider had the Order not been terminated.
- 8.3 In the event of termination the Supplier/Service Provider must submit all claims within 2 [two] months of termination after which time claims will only be met in what Transnet considers exceptional circumstances.
- 8.4 If the Goods or Services are not provided in accordance with an Order, the Order shall be deemed terminated and the Supplier/Service Provider shall compensate Transnet for any costs incurred in obtaining substitute Goods or any damage caused due to the failure or delay in the delivery.

**9 ACCESS**

The Supplier/Service Provider shall be liable for the acts, omissions and defaults of its personnel or agents who, for the purposes of the Order, shall be treated as if they are the Supplier's/Service Provider's employees. The Supplier/Service Provider shall ensure that any such personnel or agents, whilst on Transnet's premises, shall comply with Transnet's health and safety, security and system security rules and procedures as and where required.

**10 WARRANTY**

The Supplier/Service Provider warrants that it is competent to supply the Goods/Services in accordance with these Terms to the reasonable satisfaction of Transnet and that all Goods/Services delivered under the Order: (a) conform and comply in all relevant legislation, standards, directives and orders related to [inter alia] the Goods/Services in force at the time of delivery, and to any specifications referred to in the Order; (b) will not cause any deterioration in the functionality of any Transnet equipment; and (c) do not infringe any third party rights of any kind. The Supplier/Service Provider hereby indemnifies Transnet against all losses, liabilities, costs, claims, damages, expenses and awards of any kinds incurred or made against Transnet in connection with any breach of this warranty.

**11 INSOLVENCY**

If the Supplier/Service Provider shall have a receiver, manager, administrator, liquidator or like person appointed over all or any part of its assets or if the Supplier/Service Provider compounds with its creditors or passes a resolution for the writing up or administration of the Supplier/Service Provider, Transnet is at liberty to terminate the Order or Orders forthwith, or at its option, to seek performance by any such appointed person.

**12 ASSIGNMENT**

The Supplier/Service Provider shall not assign its obligations under an Order without Transnet's prior written consent, which consent shall not be unreasonably withheld or delayed.

**13 NOTICES**

Notices under these Terms shall be delivered by hand to the relevant addresses of the parties in the Order or may be served by facsimile or by email, in which event notice shall be deemed served on acknowledgement of receipt by the recipient.

**14 LAW**

Orders shall be governed by and interpreted in accordance with South African law and any disputes arising herein shall be subject to South African arbitration under the rules of the Arbitration Foundation of South Africa, which rules are deemed incorporated by reference in this clause. The reference to arbitration shall not prevent Transnet referring the matter to any South African courts, having jurisdiction, to which the Supplier/Service Provider hereby irrevocably submits but without prejudice to Transnet's right to take proceedings against the Supplier/Service Provider in other jurisdictions and/or obtaining interim relief on an urgent basis from a court of competent jurisdiction pending the decision in other courts or from instituting in any court of competent jurisdiction any proceedings for an interdict or any other injunctive relief. If the Supplier/Service Provider does not have a registered office in the South Africa it will at all times maintain an agent for service of process in South Africa and shall give Transnet the name and address of such agent as such may be amended, in writing, from time to time.

**15 GENERAL**

Completion or termination of an Order shall be without prejudice to any Term herein which by its nature would be deemed to continue after completion or termination, including but not limited to clauses 5, 6, 7, and 10. Headings are included herein for convenience only. If any Term herein be held illegal or unenforceable, the validity or enforceability of the remaining Terms shall not be affected. No failure or delay by Transnet to enforce any rights under these Terms will operate as a waiver thereof by Transnet. All rights and remedies available to either party under these Terms shall be in addition to, not to the exclusion of, rights otherwise available at law.

**16 COUNTERPARTS**

These Terms and conditions may be signed in any number of counterparts, all of which taken together shall constitute one and the same instrument. Any party may enter into this agreement by signing any such counterpart.

By signing this RFQ document, the Respondent is deemed to acknowledge that he/she has made himself/herself thoroughly familiar with all the conditions governing this RFQ, including those contained in any printed form stated to form part hereof and Transnet SOC Ltd will recognise no claim for relief based on an allegation that the Respondent overlooked any such condition or failed to properly take it into account for the purpose of calculating quoted prices or otherwise.

SIGNED at \_\_\_\_\_ on this \_\_\_\_\_ day of \_\_\_\_\_ 20\_\_\_\_\_

.....  
SIGNATURE OF RESPONDENT'S AUTHORISED REPRESENTATIVE

NAME: \_\_\_\_\_

DESIGNATION: \_\_\_\_\_

REGISTERED NAME OF COMPANY: \_\_\_\_\_

PHYSICAL ADDRESS:  
\_\_\_\_\_  
\_\_\_\_\_

**Respondent's contact person:** *[Please complete]*

Name	:	
Designation	:	
Telephone	:	
Cell Phone	:	
Facsimile	:	
Email	:	
Website	:	

**Transnet urges its clients, suppliers and the general public  
to report any fraud or corruption to  
TIP-OFFS ANONYMOUS : 0800 003 056**

.....  
Respondent's Signature

.....  
Date & Company Stamp



**Section 4**  
**VENDOR APPLICATION FORM**

**"PREVIEW COPY ONLY"**

.....  
Respondent's Signature

.....  
Date & Company Stamp



## Transnet Supplier Declaration/Application

The Financial Director or Company Secretary

Transnet Vendor Management has received a request to load your company on to the Transnet vendor database. Please furnish us with the following to enable us to process this request:

1. Complete the "Supplier Declaration Form" (SDF) on page 2 of this letter
2. **Original** cancelled cheque **OR** letter from the bank verifying banking details (**with bank stamp**)
3. **Certified** copy of Identity document of Shareholders/Directors/Members (where applicable)
4. **Certified** copy of certificate of incorporation, CM29 / CM9 (name change)
5. **Certified** copy of share Certificates of Shareholders, CK1 / CK2 (if CC)
6. A letter with the company's letterhead confirming physical and postal addresses
7. **Original** or **certified** copy of SARS Tax Clearance certificate and Vat registration certificate
8. A signed letter from the Auditor / Accountant confirming most recent annual turnover and percentage black ownership in the company **AND/OR** BBBEE certificate and detailed scorecard from an accredited rating agency (SANAS member).

**NB:**

- **Failure to submit the above documentation will delay the vendor creation process.**
- *Where applicable, the respective Transnet business unit processing your application may request further information from you. E.g. proof of an existence of a Service/Business contract between your business and the respective Transnet business unit etc.*

### IMPORTANT NOTES:

- a) If your annual turnover is less than R5 million, then in terms of the DTI codes, you are classified as an Exempted Micro Enterprise (EME). If your company is classified as an EME, please include in your submission, a signed letter from your Auditor / Accountant confirming your company's most recent annual turnover is less than R5 million and percentage of black ownership and black female ownership in the company **AND/OR** BBBEE certificate and detailed scorecard from an accredited rating agency (e.g. permanent SANAS Member), should you feel you will be able to attain a better BBBEE score.
- b) If your annual turnover is between R5 million and R35million, then in terms of the DTI codes, you are classified as a Qualifying Small Enterprise (QSE) and you claim a specific BBBEE level based on any 4 of the 7 elements of the BBBEE score-card, please include your BEE certificate in your submission as confirmation of your status.  
NB: BBBEE certificate and detailed scorecard should be obtained from an accredited rating agency (e.g. permanent SANAS Member).
- c) If your annual turnover is in excess of R35million, then in terms of the DTI codes, you are classified as a Large Enterprise and you claim a specific BEE level based on all seven elements of the BBBEE generic score-card. Please include your BEE certificate in your submission as confirmation of your status.  
NB: BBBEE certificate and detailed scorecard should be obtained from an accredited rating agency (permanent SANAS Member).
- d) To avoid PAYE tax being automatically deducted from any invoices received from you, you must also contact the Transnet person who lodged this request on your behalf, so as to be correctly classified in terms of Tax legislation.
- e) Unfortunately, No payments can be made to a vendor until the vendor has been registered, and no vendor can be registered until the vendor application form, together with its supporting documentation, has been received and processed.
- f) Please return the completed Supplier Declaration Form (SDF) together with the required supporting documents mentioned above to the Transnet Official who is intending to procure your company's services/products in order that he/she should complete and Internal Transnet Departmental Questionnaire before referring the matter to the appropriate Transnet Vendor Master Office.

Regards,

Transnet Vendor/Supplier Management .Contact person Carol tell: 021 940-3846 fax 021 940-3883.

.....  
Respondent's Signature

.....  
Date & Company Stamp



## Supplier Declaration Form

Company Trading Name							
Company Registered Name							
Company Registration Number Or ID Number If A Sole Proprietor							
Form of entity	CC	Trust	Pty Ltd	Limited	Partnership	Sole Proprietor	
VAT number (if registered)							
Company Telephone Number							
Company Fax Number							
Company E-Mail Address							
Company Website Address							
Bank Name				Bank Account Number			
Postal Address				Code			
Physical Address				Code			
Contact Person							
Designation							
Telephone							
Email							
Annual Turn-over Range (Last Financial Year)		< R5 Million		R5-35 million		>R35 million	
Does Your Company Provide		Products		Services		Both	
Area Of Delivery		National		Provincial		Local	
Is Your Company A Public Or Private Entity				Public		Private	
Does Your Company Have A Tax Directive Or IRP30 Certificate				Yes		No	
Main Product Or Service Supplied (E. G.: Stationery/Consulting)							
<b>BEE Ownership Details</b>							
%Black Ownership		% Black women ownership		% Disabled person/s ownership			
Does your company have a BEE certificate		Yes		No			
What is your broad based BEE status (Level 1 to 9 / Unknown)							
How many personnel does the firm employ		Permanent		Part time			
Transnet Contact Person							
Contact number							
Transnet operating division							
<b>Duly Authorised To Sign For And On Behalf Of Firm / Organisation</b>							
Name				Designation			
Signature				Date			
<b>Stamp And Signature Of Commissioner Of Oath</b>							
Name				Date			
Signature				Telephone No.			

NB: Please return the completed Supplier Declaration Form (SDF) together with the required supporting documents mentioned above to the Transnet Official who is intending to procure your company's services/products.

Transnet Vendor/Supplier Management .Contact person Carol tel: 021 940-3846 fax 021 940-3883

Respondent's Signature

Date & Company Stamp

A:

- 1.1 This project specification covers Transnet freight rail's requirements for the supply, install, test and commission of DC control panel and associated equipment at HEUNINGSPRUIT, JORDAAN, BOSRAND AND GLEN 3kV Tie Stations under the control of Depot Engineer, Bloemfontein.

B:

- 1.1 The Contractor shall not make use of any sub-Contractor to perform the works or parts thereof without prior permission from the Project Manager.
- 1.2 The Contractor shall ensure that a safety representative is at site at all times.
- 1.3 The Contractor shall comply with all applicable legislation and Transnet safety requirements adopted from time to time and instructed by the Project Manager / Supervisor. Such compliance shall be entirely at his own cost, and shall be deemed to have been allowed for in the rates and prices in the contract.
- 1.4 The Contractor shall, in particular, comply with the following Acts and Transnet Specifications:-
- 1.4.1 The Compensation for Occupational Injuries and Diseases Act, No. 130 of 1993. The Contractor shall produce proof of his registration and good standing with the Compensation Commissioner in terms of the Act.
- 1.4.2 The Occupational Health and Safety Act (Act 85 of 1993).
- 1.4.3 The explosive Act No. 26 of 1956 (as amended). The Contractor shall, when applicable, furnish the Project Manager / Supervisor with copies of the permits authorising him or his employees, to establish an explosives magazine on or near the site and to undertake blasting operations in compliance with the Act.
- 1.4.4 The Contractor shall comply with the current Transnet Specification E.4E, Safety Arrangements and Procedural Compliance with the Occupational Health and Safety Act, Act 85 of 1993 and Regulations and shall before commencement with the execution of the contract, which shall include site establishment and delivery of plant, equipment or materials, submit to the Project Manager / Supervisor.
- 1.4.5 The Contractor shall comply with the current Specification for Works On, Over, Under or Adjacent to Railway Lines and near High Voltage Equipment – E7/1, if applicable, and shall take particular care of the safety of his employees on or in close proximity to a railway line during track occupations as well as under normal operational conditions.
- 1.5 The Contractor's Health and Safety Programme shall be subject to agreement by the Project Manager / Supervisor, who may, in consultation with the Contractor, order supplementary and/or additional safety arrangements and/or different safe working methods to ensure full compliance by the Contractor with his obligations as an employer in terms of the Act.
- 1.6 In addition to compliance with clause 1.4 hereof, the Contractor shall report all incidents in writing to the Project Manager / Supervisor. Any incident resulting in the death of or injury to any person on the works shall be reported within 24 hours of its occurrence and any other incident shall be reported within 48 hours of its occurrence.
- 1.7 The Contractor shall make necessary arrangements for sanitation, water and electricity at these relevant sites during the installation of the equipments.
- 1.8 A penalty charge of **R1,000.00** per day will be levied for late completion.
- 1.9 The Contractor shall supply a **site diary** (with triplicate pages). This book shall be used to record any unusual events during the period of the work. Any delays to the work shall also be recorded such as delays caused by poor weather conditions, delays caused by permits being cancelled etc. The appointed Project Manager or Supervisor must countersign such delays. Other delays such as non-availability of equipment from 3<sup>rd</sup> party suppliers must be communicated to the Project Manager or Supervisor in writing.

- 1.10 The Contractor shall supply a **site instruction book** (with triplicate pages). This book shall be used to record any instructions to the Contractor regarding problems encountered on site – for example the quality of work or the placement of equipment. This book shall be filled in by the Project Manager or Supervisor and must be countersigned by the Contractor.
- 1.11 Both books mentioned in 1.10 and 1.11 shall be the property of Transnet Freight Rail and shall be handed over to the Project Manager or Supervisor on the day of energising or handing over.
- 1.12 All processes or the manufacture and assembly of the product components must be subjected to a quality assurance system.
- 1.13 The Contractor will assume full responsibility for assuring that the products purchased meet the requirements of Transnet Freight Rail for function, performance, and reliability, including purchased products from 3<sup>rd</sup> part suppliers/Manufacturers.
- 1.14 The Contractor shall prove to Transnet Freight Rail that his equipment or those supplied from 3<sup>rd</sup> party suppliers/manufacturers confirms to Transnet freight rail specifications.
- 1.15 The Contractor will remain liable for contractual delivery dates irrespective of deficiencies discovered during workshop inspections.

## **2.0 TENDERING PROCEDURE**

- 2.1 An addendum reflecting changes to the project specification and 'Bill of Quantities' shall be forwarded to Contractors after the site meeting and Contractors shall quote accordingly, failure of which will result in disqualification.
- 2.2 Contractors shall duly fill in the attached 'Bill of Quantities'. Items not reflected in the 'Bill of Quantities', but covered in the project specification or agreed at site meetings, shall be added to the 'Bill of Quantities' by the Contractor and quoted for accordingly.
- 2.3 Contractors shall submit qualifications of staff that will be performing the works. Only qualified technical personnel shall perform the works on the electrical equipment or installations thereof.
- 2.4 During the duration of the contract, the successful Contractor shall be required to inform the Supervisor of any staff changes and provide the qualifications of the replacement staff for approval.
- 2.5 Contractors shall indicate clause-by-clause compliance with the specifications. This shall take the form of a separate document listing all the specifications clause numbers indicating the individual statement of compliance or non-compliance.
- 2.6 Contractors shall motivate a statement of non-compliance.
- 2.7 The successful Contractor shall provide a Gantt or a similar chart showing when the works will be done and energised. This chart shall be submitted to the Project Manager or Supervisor within 14 days after the award of the contract has been made to the successful Contractor.
- 2.8 Where equipment offered does not comply with standards or publications referred to in the specification, Contractors shall state which standards apply and submit a copy in English or certified translation.
- 2.9 Contractors shall submit descriptive literature consisting of detailed technical specifications, general constructional details and principal dimensions, together with clear illustrations of the equipment offered.
- 2.10 During the duration of the contract period, the successful Contractor shall be required to inform the Project Manager / Supervisor of any changes to equipment offered and submit detailed information on replacement equipment for approval prior to it being used on this contract.
- 2.11 Contractors shall submit equipment type test certificates as specified on the contract. These shall be in English or certified translation.

## **3.0 SERVICE CONDITIONS**

- 3.1 Control Panel shall be designed and rated for continuous operation under the following conditions:
- 3.2 Atmospheric Conditions
  - Altitude 0 to 1800m above sea level
  - Ambient Temperature -5 to +45 Degree Celsius

- Relative Humidity 10% to 90%
- Lighting Conditions 12 ground flashes per square kilometre per annum
- Pollution Heavily salt laden or polluted with smoke from industrial sources

### 3.3 Mechanical

The substation in which the panels will be installed is situated next to railway line and the equipment will therefore be subjected to vibrations. The design must take appropriate counter measure to ensure reliability of equipment that are sensitive.

### 3.4 Electrical

Nominal DC control voltage 110V (Minimum being 88V and maximum 128V)  
 Nominal AC auxiliary 400 V / 230 V, 50HZ

### 3.5 GENERAL REQUIREMENT OF CONTROL/DISTRIBUTION PANEL

The successful supplier shall be responsible for the design, the ratings of all, cabling, wiring protection circuitry, sizing of contactors, relays, moulded circuit breakers, (mcb's) Isolators, fused isolators, fuse ratings, terminations and any other equipment and circuitry used. In the event of a dispute, Transnet Freight Rail staff's shall make the final decision on technical matters

The construction of the control/distribution panel shall be either two separate panels or a combination of both into one panel with the AC and DC circuitry separated.

The control/distribution panels shall be so designed that the control switches are accessible and indicating lights, flag indicators, volt and ammeters are visible without opening the doors.

All circuit shall be wired in the fail to safe mode i.e. relays and contactors must be de-energised under fault conditions.

All relays, control switches, indicating lights and control push buttons, etc. which are mounted on panel door shall be suitably labelled to clearly indicate their function. The labels shall be engraved with white lettering on a black background and permanently fixed with miniature screws, rivets or high adhesive.

Laminated plastised labels shall be used for labelling inside the panel and panel door. The lettering shall be either engraved or etched.

### 3.6 DC EARTH LEAKAGE PROTECTION RELAY

- 3.6.1 The DC earth leakage relay shall not be fitted in the control panel but on the outside of the control panel. In the case of space constraints (single unit substations) the relay maybe mounted on the wall or other locations, which shall be decided after consultation with Transnet Freight Rail staff.
- 3.6.2 The steelwork of all 3kV DC equipment installed in traction substation is connected to a DC earth leakage busbar which is mounted on insulators. This busbar is connected to the substation negative (which is near potential) through the DC earth leakage relay by means of two 95mm squared PVC insulated copper cables. In the event of a failure of the 3KV DC insulation, the fault current flows to rail by way of the relay causing its operation at the calibrated current setting.
- 3.6.3 The DC earth leakage busbar shall be installed so that it passes through the aperture of the DC earth leakage relay. The one side of the busbar is connected to the substation negative and the steelwork of the electrical equipment is connected on the other side.
- 3.6.4 A suitable DC earth leakage relay shall be provided that will trip at a predetermined value in the event of failure of the 3KV insulation.
- 3.6.5 The DC earth leakage copper busbar dimensions minimum 50X10mm squared shall be provided for provisions to be made for a minimum of ten 95 square mm conductor lugs.
- 3.6.6 The connection between the DC earth leakage primary busbar and the steelwork of the equipment inside the substation shall be made by means of 95 square mm PVC insulated conductors. (Drawing CEE-TBD-7 which shows a typical layout of the interconnections between the steelwork of the equipment and the DC earth leakage busbar)
- 3.6.7 The DC earth leakage relay shall be robustly constructed and protected against the ingress of dust dirt and moisture.

- 3.6.8 The DC earth leakage relay shall have position provision for lead and wire sealing to prevent unauthorised tampering with calibration.
- 3.6.9 The operation of the DC earth leakage relay shall be instantaneous.
- 3.6.10 The DC earth leakage relay shall be provided with flag indicator and facilities for electrical remote flag indication.
- 3.6.11 The DC earth leakage relay shall incorporate sufficient auxiliary contacts to enable the correct operation of the circuit. The contacts shall be continuously rated to carry and make or break a 5 A/110V inductive circuit.
- 3.6.12 The aperture of the magnetic core of the DC earth leakage relay shall be large enough to accommodate two 95mm squared PVC insulated copper conductors, which connect the DC earth leakage busbar to substation negative.(See Engineering Instruction S.013 Issue)
- 3.6.13 The DC earth leakage relay shall be capable of operating under short circuit conditions where the fault current could be in the order of 50 kA DC and the possible rate of rise between 3 and 6kA per second.
- 3.6.14 The trip settings of the DC earth leakage relay shall be easily adjustable in the range 10-200Amp. The trip setting shall be indicated on dial and pointer to facilitate calibration.
- 3.6.15 The calibration must be stable and accurate to plus minus 10% of the trip setting of the DC earth leakage relay.
- 3.6.16 The DC earth leakage relay shall be protected from accidental damage or contact by a sturdy enclosure manufactured from a suitable transparent non-conductive material.
- 3.6.17 Copper busbar shall be insulated from the mounting surface by means of suitable insulators etc. and provision shall be for the termination of the earthing conductors.

#### **4.0 AC/DC DISTRIBUTION PANEL**

- The panel shall make provision for:
  - AC Distribution (400V,3 phase)
  - DC Distribution (110 V DC)
  - DC Control and supervisory circuitry and track breaker control

#### **5.0 AC DISTRIBUTION (400V, 3 PHASE)**

- 3 phase 15 kA short circuit rated, 415 V moulded case circuit breaker / fused isolator for the protection of the three phase auxiliary transformer supply. The fused isolator shall be the AEG or equivalent type that has been approved by Technology Management.
- Bus bar protected by clear Perspex barriers shall be marked with a danger sign and 400V.
- Current Transformers in the control panel for the measurement of the low voltage currents for each phase of the 400V supply.
- Ammeter and voltmeter for the measurement of the 3 phase currents and voltages.
- Suitable four way rotary selector switches for the measurement of the 3 phase current and voltages.

#### **5.2 400V 3 Phase Distribution Supply**

- The following 3 phase supplies are normally required but could vary for each substation. These supplies shall be individually protected by moulded case circuit breakers.
  - 60A calibration set supply
  - Substation distribution board
  - Battery room fan including overload protection

### 5.3 230 V SINGLE PHASE DISTRIBUTION SUPPLY

The following single phase supplies are normally required but vary for each substation. These supplies shall be individually protected by moulded cased circuit breakers.

- Telecontrol supply
- 3 pin 230V, 15 A socket outlet protected by earth leakage unit accordance with SANS 10142.
- Battery charger supply.
- Substations distribution board and lights

### 6.0 INDICATING INSTRUMENT FOR THE 400V AC DISTRIBUTION

The panel shall be fitted with the following indicating instrument for the AC distribution auxiliary supply

- One 0 to 400V voltmeter with its own selector switch. The instrument shall be labelled AC VOLTS
- One 0 to 100 A ampere meter with its own selector switch. The instrument shall be labelled "AC AMPERES

### 7.0 110 DC VOLTS DISTRIBUTION

- The 110 V DC supply shall be obtained from the substation battery bank, which is charged by a freestanding battery charger unit. Refer to Transnet Freight Rail's specification BBB 2502 latest version. The installation of battery charger in the AC/DC distribution panel is not acceptable.

### 8.0 PANEL CONSTRUCTION

- AC/DC distribution panel shall be constructed in accordance to BBB2721 version 10 Transnet Freight Rail specification for compatibility of Tie Station standard of works, with exclusive of none required functionalities clauses 13.3,13.5,13.8 from BBB 2721 version 10.

Refer: 9.3 to 22.0 of BBB 2721 version 10

### 9.0 AC/DC DISTRIBUTION PANEL

- 9.1 The design, supply and installation of panels for controlling electrical circuitry equipment shall be the responsibility of the Contractor. This shall be in accordance with Transnet freight rail specification BBB2721 Version 10 pertaining to Tie Station compatibility.
- 9.2 The manufacture of panels shall not take place prior to the approval of the design drawings by the Supervisor/ Electrical Officer.
- 9.3 Transnet Freight Rail shall inspect the panels at the manufacturers works prior to dispatch.
- 9.4 All fasteners (nuts & bolts) shall be secured using flat and spring washers where necessary.
- 9.5 All steelwork shall be galvanized in accordance with SANS 121 and, where required painted in accordance with specification CEE 045 of 2002/1.

### 10.0 INSTALLATION

- 10.1 The Contractor shall be responsible for the transport to site, off-loading, handling, storage and security of all material required for the construction/execution of the works.
- 10.2 Contractor shall supply multi core cable and connect the tele-control. The substation shall not be switched on unless the tele-control is fully operational.
- 10.3 Contractor shall supply and install 3kV copper bus bars at the 3kV Chamber and earthing
- 10.4 Transnet shall free issue battery charger for the contractor to install
- 10.5 Transnet shall free issue butt contact and finger contact for breaker cells for contractor to install.
- 10.6 Contractor shall supply and install wall bushings of appropriate voltage capacity



- 10.7 Contractor shall supply and install 3kV positive cable from the wall bushing to the bus bar chamber bus connections laid in cable tray

## 11.0 INTERCONNECTION OF EQUIPMENT

- 11.1 High conductive silicon grease shall be liberally applied to all the connections.
- 11.2 All dissimilar metal connections (Cu to Al) shall be made using bi-metallic clamps that are specifically designed and manufactured to make that particular connection (ad hoc fabricated clamps are not acceptable).

## 12.0 SITE TESTS

- 12.1 The equipment shall be inspected / tested and approved by Transnet Freight Rail Quality Assurance at the Contractor's workshop prior to it being taken to site. Only once the approval has been granted can the equipment be taken to site for installation.
- 12.2 The Contractor shall be responsible for carrying out of on-site tests and commissioning of all equipment supplied and installed in terms of this specification and the contractual agreement.
- 12.3 Functional on-site tests shall be conducted on all items of equipment and circuitry to prove the proper functioning and installation thereof.
- 12.4 The Contractor shall submit a detailed list of on-site tests for the approval of the Project Manager or Supervisor.
- 12.5 The Contractor shall arrange for the Supervisor or his representative to be present to witness the on-site tests.
- 12.6 The on-site tests and subsequent commissioning **will not commence until ALL CONSTRUCTION** work has been completed. Construction staff, material and equipment shall be removed from site prior to the commencement of testing. Testing and commissioning of the power plants equipment will not be allowed to take place in a construction site environment.
- 12.7 The on-site tests shall include the following:

**13.0 Test for the functionality of all electrical circuitry.**

**14.0 Trip tests on relays.**

**15.0 Test on equipment as per manufacturer's instructions.**

**16.0 Insulation tests.**

- 16.1 At the completion of the on-site tests, the Project Manager or Supervisor or his representative shall either sign the tests sheets (supplied by the Contractor) as having witnessed the satisfactory completion thereof, or hand to the Contractor a list of defects requiring rectification.
- 16.2 Upon rectification of defects, the Contractor shall arrange for the Project Manager or Supervisor or his representative to certify satisfactory completion of on-site tests.
- 16.3 Acceptance by the Project Manager or Supervisor of satisfactory completion of on-site tests in no way relieves the Contractor of his obligation to rectify defects which may have been overlooked or become evident at a later stage.

## 17.0 COMMISSIONING OF EQUIPMENT

- 17.1 Commissioning will only take place after all defects have been rectified to the satisfaction of the Project Manager or Supervisor.
- 17.2 On completion of commissioning, the Contractor will hand the equipment over to the Project Manager or Supervisor in terms of the relevant instruction.
- 17.3 The commissioning of protection equipment by Transnet Freight Rail will in no way absolve the Contractor from any of his responsibilities during the guarantee period.

- 17.4 It is the Contractor's responsibility to satisfy himself or herself that the commissioning of the protection equipment has been carried out in a satisfactory manner, and in no way compromises the proper operation of the equipment supplied in terms of the contract.
- 17.5 The Contractor shall be present during the testing and setting of the protection to rectify any faults found.

#### **18.0 GUARANTEE AND DEFECTS**

- 18.1 The Contractor shall guarantee the satisfactory operation of the complete electrical installation supplied and erected by him and accept liability for maker's defects that may appear in design, materials and workmanship.
- 18.2 The Contractor shall be issued with a completion certificate with the list of all defects to be repaired within 14 working days after commissioning.
- 18.3 The guarantee period for these standby plants shall expire after a period of 12 months commencing on the date of completion of the contract or the date the standby plant was handed over to Transnet Freight Rail.
- 18.4 Any defects that may become apparent during the guarantee period shall be rectified to the satisfaction of Transnet Freight Rail, and to the account of the Contractor.
- 18.5 The Contractor shall undertake work on the rectification of any defects that may arise during the guarantee period within 7-days of him being notified by Transnet Freight Rail of such defects.
- 18.6 Should the Contractor fail to comply with the requirements stipulated above, Transnet Freight Rail shall be entitled to undertake the necessary repair work or effect replacement of defective apparatus or materials, and the Contractor shall reimburse Transnet Freight Rail the total cost of such repair or replacements, including the labour costs incurred in replacing defective material.
- 18.7 Any specific type of fault occurring three times within the guarantee period and which cannot be proven to be due to other faulty equipment not forming part of this contract e.g., faulty locomotive or overhead track equipment, etc., shall automatically be deemed an inherent defect. Such inherent defect shall be fully rectified to the satisfaction of the Project Manager or Supervisor and at the cost of the Contractor.
- 18.8 If urgent repairs have to be carried out by Transnet Freight Rail staff to maintain supply during the guarantee period, the Contractor shall inspect such repairs to ensure that the guarantee period is not affected and should they be covered by the guarantee, reimburse Transnet Freight Rail the cost of material and labour.

#### **19.0 QUALITY AND INSPECTION**

- 19.1 Transnet Freight Rail shall inspect the equipment under contract on the premises of the Manufacturer or successful Contractor.
- 19.2 The Contractor shall notify Transnet Freight Rail 14 days in advance of such an inspection date.
- 19.3 The Contractor shall apply 14 days in advance for the date of energizing and ensure that all work is completed before any commissioning can take place.
- 19.4 The Contractor shall be responsible to issue a compliance certificate in terms of SANS 0142 for each site before energizing of the equipment shall take place.

**20.0 Specifications****20.1 South African National Standards:**

21.0	SANS 1091	National colour standard.
22.0	SANS 763	Hot dip galvanised zinc coating.
22.1.1	SANS 121	Hot Dip Galvanised Coating for Fabricated Iron or Steel Article.
22.1.2	SANS 8528	Reciprocating internal combustion engine driven alternating current generating set.
22.1.3	SANS 10142	Wiring Code.

**NOTE: Any other specifications referenced in the above mentioned specification, will be for information purposes and may be provided on request.**

**22.3** Occupational Health and Safety Act No. 85 of 1993 (Available at depot for referral)

**23.0 Constraints on how the Contractor Provides the Works**

23.1 The constraints shall be as specified in the specifications of the particular equipment.

**24.0 Requirements for the programme**

24.1	Programme of work	: To be submitted by successful Contractor
24.2	CIDB rating	: 1EPPE OR 2EP and above
24.3	Format	: Bar chart
24.4	Information	: How work is going to be executed and commissioned
24.5	Submission	: Not Applicable
24.6	Site diary	: Successful Contractor to supply in triplicates carbon copies
24.7	Site instruction book	: Successful Contractor to supply in triplicates carbon copies

**25.0 Services and other things provided by the Employer**

25.1 Transnet Freight Rail shall have an electrician available for isolation and the erection of barriers to live electrical equipment and issuing of work permits.

25.2 Upon successful completion of the works to the satisfaction of Transnet Freight Rail, Transnet Freight Rail shall perform necessary protection tests and commission the equipment.

**26.0 Safety information**

The Contractor shall comply with requirements of safety legislation and regulations in all respects.

Security of all of the Contractor's staff, vehicles, machinery, equipment and materials shall remain the responsibility of the Contractor. The Contractor may use Transnet Freight Rail premises from time to time but the responsibility and cost to provide security, which may be required, shall be for the Contractor's account. No separate payment shall be made and the cost thereof shall be deemed to be included in the rates tendered. Transnet Freight Rail shall entertain no claims whatsoever in this regard.

The Contractor shall prepare and submit to Transnet Freight Rail at the start of the contract, a comprehensive safety plan which shall also cover the following headings:

Transportation of flammable / explosive materials and / or equipment on the same road or rail vehicle as personnel.

Storing flammable/explosive materials and/or equipment.

Fire prevention and fire fighting plan.

Safety procedures for staff when working on double line sections.  
Safe working procedure for all aspects of the operation, inclusive of all moving of machinery by rail if required by the Contractor.

The method of work shall be such that at all times it shall comply with Transnet Freight Rail Specification E7/1.

Normal protection measures in accordance with the Transnet Freight Rail Protection Manual shall apply.

All protection arrangements shall at all times remain under the supervision and responsibility of a Transnet Freight Rail Traction Linesman. No work is permitted if an occupation is not approved.

The Contractor shall not allow any persons on the work site to venture within the structure gauge of any adjacent line when this warning procedure is not operating effectively.

An effective safety procedure to be followed by all personnel on any work site in the case of approaching rail traffic shall be compiled by the Contractor and implemented before any work commences. This procedure shall be updated whenever the need arises and any changes shall be communicated to all employees on a work site before work proceeds.

All reasonable steps to effectively prevent the occurrence of veld fires shall be required from the Contractor. Such fire fighting equipment and resources deemed necessary to effectively fight any veld fire, which may occur as a result of the work, shall be required at each relay site and shall form part of this contract. The cost to provide such fire fighting equipment and resources shall be deemed to be included in the rates tendered and no separate payment shall be made for this.

No separate payment shall be made for the safety measures and the costs hereof will be deemed to be included in the rates tendered.

## **Training**

### **General**

The Contractor shall ensure that all staff working on or with the contract is adequately trained, so as to comply with any relevant safety and quality requirements.

It is the Contractor's responsibility to ensure that his personnel are trained. At the commencement of the contract, Transnet Freight Rail shall assist the contractor with the initial on-the-job training of the staff as specified below, so as to assist the Contractor to qualify the workers / staff. The Contractor shall ensure that he has a core group of workers with sufficient previous experience to take the lead in undertaking maintenance tasks.

Where the Contractor requires training and Transnet Freight Rail is committed to provide this training, the contractor shall quantify in his tender as to what and how many staff, training will be required. After award of the contract, the contractor shall then arrange with the appropriate Transnet Freight Rail Production Manager (OHTE), through the Technical Officer, for this training / testing.

The Contractor's Supervisor shall take full charge of the Contractor's resources on the work site. An employee / agent appointed by the contractor, will not act as, or be allowed to take on any responsibility as, the *person-in-charge-of-the-occupation*. The function of *person-in-charge-of-the-occupation* is restricted to competent Transnet Freight Rail employees only.

The *person-in-charge-of-the-occupation* shall be a competent Transnet Freight Rail employee, reporting to the Transnet Freight Rail Depot Engineer. This person shall be responsible for the following on a work site:

- Taking occupations
- Cancelling the occupation
- Communication with Control with regard to occupation matters.

The Transnet Freight Rail Depot Engineer remains ultimately responsible in terms of the requirements of Act 85 for the safe working environment of his own personnel as well as contractor's personnel within the track maintenance environment on his depot.

The Depot Engineer is therefore also responsible for ensuring that any changes in the Protection Procedures that may occur over time are effectively communicated his own personnel as well as contractor's personnel within the track maintenance environment on his depot

Electrical awareness, Educational and competency training

The following training shall be arranged for the following Contractors staff:

The electrical awareness training must be arranged for beforehand on-the-job.

a)

The electrical educational and competency training may be arranged for at either a depot's lecture room (Transnet Freight Rail property), or at a venue of the Contractors choice (Contractors cost).

Transnet Freight Rail will provide the Accredited Electrical Trainer, from Transnet Freight Rail, at Transnet Freight Rail cost, provided that an arrangement for the training session required, is done beforehand and will fit in with the Trainers training program for the year.

Course	Objective	Duration & trainer	Grade to attend
A) Awareness (Electrical)	To inform all contractors staff working near a machine and on the line on electrified sections of the dangerous situations of high voltage OHTE and substations.	Two-hour on-the-job lecture and training. <b>Accredited Electrical Trainer / Depot's Electrical technical officer.</b>	<ul style="list-style-type: none"> <li>All workers and staff working on the contract</li> </ul>
B) PWC Educational (Electrical)	For the safe working on and with On-track machinery in the vicinity or near exposed High voltage OHTE and substations.	Lecture room training = 1,25 d On-the-job training = 0,25 d Criterion test = 0,5 d Total = <b>2 days</b> <b>Accredited Electrical trainer</b>	<ul style="list-style-type: none"> <li>Workers working on a machine (High risk area's)</li> <li>Operators</li> <li>Machine fitters</li> <li>Area supervisors</li> <li>Contract supervisors</li> </ul>
C) COM Competency (Electrical) (To follow A) (PWC)	Work permits safe working procedures under the direct supervision of a responsible representative.	Lecture room training = 0,25 d On-the-job training = 0,25 d Criterion test = 0,5 days Total = <b>1 day</b> <b>Accredited Electrical trainer</b>	Supervisor (Responsible person in charge at machine working)

**TRANSNET SOC LIMITED**

(Registration no. 1990/000900//30)

**SAFETY ARRANGEMENTS AND PROCEDURAL COMPLIANCE  
WITH THE OCCUPATIONAL HEALTH AND SAFETY ACT  
(ACT 85 OF 1993) AND APPLICABLE REGULATIONS****1. General**

- 1.1 The Contractor and Transnet Limited (hereinafter referred to as "Transnet") are individual employers, each in its own right, with their respective duties and obligations set out in the Occupational Health and Safety Act, Act 85 of 1993 (the Act) and applicable Regulations.
- 1.2 The Contractor accepts, in terms of the General Conditions of Contract and in terms of the Act, his obligations as an employer in respect of all persons in his employ, other persons on the premises or the Site or place of work or on the work to be executed by him, and under his control. He shall, before commencement with the execution of the contract work, comply with the provisions set out in the Act, and shall implement and maintain a Health and Safety Plan as described in the Construction Regulations, 2003 and as approved by Transnet, on the Site and place of work for the duration of the Contract.
- 1.3 The Contractor accepts his obligation to complying fully with the Act and applicable Regulations notwithstanding the omission of some of the provisions of the Act and the Regulations from this document.
- 1.4 Transnet accepts, in terms of the Act, its obligations as an employer of its own employees working on or associated with the site or place of work, and the Contractor and Technical Officer or his deputy shall at all times, co-operate in respect of the health and safety management of the site, and shall agree on the practical arrangements and procedures to be implemented and maintained during execution of the Works.
- 1.5 In the event of any discrepancies between any legislation and this specification, the applicable legislation will take precedence.

**2. Definitions**

- 2.1 In this Specification any word or expression to which a meaning has been assigned in the Construction Regulations, shall have the meaning so assigned to it, unless the context otherwise indicates: -
- 2.2 The work included in this Contract shall for the purposes of compliance with the Act be deemed to be "**Construction Work**", which, in terms of the Construction Regulations, 2003 means any work in connection with: -
- (a) the erection, maintenance, alteration, renovation, repair, demolition or dismantling of or addition to a building or any similar structure;
  - (b) the installation, erection, dismantling or maintenance of fixed plant where such work includes the risk of a person falling;
  - (c) the construction, maintenance, demolition or dismantling of any bridge, dam, canal, road, railway, runway, sewer or water reticulation system or any similar civil engineering structure; or
  - (d) the moving of earth, clearing of land, the making of an excavation, piling, or any similar type of work;
- 2.3 "**competent person**" in relation to construction work, means any person having the knowledge, training and experience specific to the work or task being performed: Provided that where appropriate qualifications and training are registered as per the South African Qualifications Authority Act, 1995 these qualifications and training shall be deemed to be the required qualifications and training;
- 2.4 "**contractor**" means principal contractor and "subcontractor" means contractor as defined by the Construction Regulations, 2003.

- 2.5 **"fall protection plan"** means a documented plan, of all risks relating to working from an elevated position, considering the nature of work undertaken, and setting out the procedures and methods applied to eliminate the risk;
- 2.6 **"health and safety file"** means a file, or other record in permanent form, containing the information required to be kept on site in accordance with the Act and applicable Regulations;
- 2.7 **"Health and Safety Plan "** means a documented plan which addresses the hazards identified and include safe work procedures to mitigate, reduce or control the hazards identified;
- 2.8 **"Risk Assessment"** means a programme to determine any risk associated with any hazard at a construction site, in order to identify the steps needed to be taken to remove, reduce or control such hazard;
- 2.9 **"the Act"** means the Occupational Health and Safety Act No. 85 of 1993.

### 3. Procedural Compliance

- 3.1 The Contractor who intends to carry out any construction work shall, before carrying out such work, notify the Provincial Director in writing if the construction work:-
- (a) includes the demolition of a structure exceeding a height of 3 metres; or
  - (b) includes the use of explosives to perform construction work; or
  - (c) includes the dismantling of fixed plant at a height greater than 3m,
- and shall also notify the Provincial Director in writing when the construction work exceeds 30 days or will involve more than 300 person days of construction work and if the construction work:-
- (a) includes excavation work deeper than 1m; or
  - (b) includes working at a height greater than 3 metres above ground or a landing.
- 3.2 The notification to the Provincial Director shall be on a form similar to Annexure A of the Construction Regulations, 2003, also shown in Annexure 1 of this Specification. The Contractor shall ensure that a copy of the completed notification form is kept on site for inspection by an inspector, Technical Officer or employee.
- 3.3 The Contractor shall, in accordance with the Act and applicable Regulations, make all the necessary appointments of competent persons in writing on a form similar to Annexure 2 of this Specification and deliver copies thereof to the Technical Officer. Copies should also be retained on the health and safety file.
- 3.4 Subcontractors shall also make the above written appointments and the Contractor shall deliver copies thereof to the Technical Officer.
- 3.5 In the case of a self-employed Contractor or any subcontractor who has the appropriate competencies and supervises the work himself, the appointment of a construction supervisor in terms of regulation 6.1 of the Construction Regulations, 2003 will not be necessary. The Contractor shall in such a case execute and sign a declaration, as in Annexure 3, by which he personally undertakes the duties and obligations of the "Chief Executive Officer" in terms of section 16(1) of the Act.
- 3.6 The Contractor shall, before commencing any work, obtain from the Technical Officer an access certificate as in Annexure 4 executed and signed by him, permitting and limiting access to the designated site or place of work by the Contractor and any subcontractors under his control.
- 3.7 Procedural compliance with Act and Regulations, as above, shall also apply to any subcontractors as employers in their own right. The Contractor shall furnish the Technical Officer with full particulars of such subcontractors and shall ensure that they comply with the Act and Regulations and Transnet's safety requirements and procedures.

### 4. Special Permits

Where special permits are required before work may be carried out such as for hotwork, isolation permits, work permits and occupations, the Contractor shall apply to the Technical Officer or the

relevant authority for such permits to be issued. The Contractor shall strictly comply with the conditions and requirements pertaining to the issue of such permits.

## 5. Health and Safety Programme

- 5.1 The Tenderer shall, with his tender, submit a Health and Safety Programme setting out the practical arrangements and procedures to be implemented by him to ensure compliance by him with the Act and Regulations and particularly in respect of: -
- (i) The provision, as far as is reasonably practical, of a working environment that is safe and without risk to the health of his employees and subcontractors in terms of section 8 of the Act;
  - (ii) the execution of the contract work in such a manner as to ensure in terms of section 9 of the Act that persons other than those in the Contractor's employment, who may be directly affected by the contract work are not thereby exposed to hazards to their health and safety;
  - (iii) ensuring, as far as is reasonably practical, in terms of section 37 of the Act that no employee or subcontractor of the Contractor does or omits to do any act which would be an offence for the Contractor to do or omit to do.
- 5.2 The Contractor's Health and Safety Programme shall be based on a risk assessment in respect of the hazards to health and safety of his employees and other persons under his control that are associated with or directly affected by the Contractor's activities in performing the contract work and shall establish precautionary measures as are reasonable and practical in protecting the safety and health of such employees and persons.
- 5.3 The Contractor shall cause a risk assessment contemplated in clause 5.2 above to be performed by a competent person, appointed in writing, before commencement of any Construction Work and reviewed during construction. The Risk Assessments shall form part of the Health and Safety programme to be applied on the site and shall include at least the following:
- (a) The identification of the risks and hazards that persons may be exposed to;
  - (b) the analysis and evaluation of the hazards identified;
  - (c) a documented Health and Safety Plan, including safe work procedures to mitigate, reduce or control the risks identified;
  - (d) a monitoring and review plan.
- 5.4 The Health and Safety Plan shall include full particulars in respect of: -
- (a) The safety management structure to be instituted on site or place of work and the names of the Contractor's health and safety representatives and members of safety committees where applicable;
  - (b) the safe working methods and procedures to be implemented to ensure the work is performed in compliance with the Act and Regulations;
  - (c) the safety equipment, devices and clothing to be made available by the Contractor to his employees;
  - (d) the site access control measures pertaining to health and safety to be implemented;
  - (e) the arrangements in respect of communication of health and safety related matters and incidents between the Contractor, his employees, subcontractors and the Technical Officer with particular reference to the reporting of incidents in compliance with Section 24 and General Administrative Regulation 8 of the Act and with the pertinent clause of the General Conditions of Contract forming part of the Contract and
  - (f) the introduction of control measures for ensuring that the Safety Plan is maintained and monitored for the duration of the Contract.
- 5.4 The Health and Safety programme shall be subject to the Technical Officer's approval and he may, in consultation with the Contractor, order that additional and/or supplementary practical arrangements and procedures be implemented and maintained by the Contractor or that different working methods or safety equipment be used or safety clothes be issued which, in the Technical Officer's opinion, are



necessary to ensure full compliance by the Contractor with his obligations as an employer in terms of the Act and Regulations. The Technical Officer or his deputy shall be allowed to attend meetings of the Contractor's safety committee as an observer.

- 5.5 The Contractor shall take reasonable steps to ensure that each subcontractor's Health and Safety Plan is implemented and maintained on the construction site: Provided that the steps taken, shall include periodic audits at intervals mutually agreed to between the them, but at least once every month.
- 5.6 The Contractor shall stop any subcontractor from executing any construction work, which is not in accordance with the Contractor's, and/or subcontractor's Health and Safety Plan for the site or which poses a threat to the health and safety of persons.
- 5.7 The Contractor shall ensure that a copy of the Health and Safety Plan is available on site for inspection by an inspector, Technical Officer, agent, subcontractor, employee, registered employee organisation, health and safety representative or any member of the health and safety committee.
- 5.8 The Contractor shall consult with the health and safety committee or, if no health and safety committee exists, with a representative group of employees, on the development, monitoring and review of the Risk Assessment.
- 5.9 The Contractor shall ensure that all employees under his control are informed, instructed and trained by a competent person regarding any hazard and the related work procedures before any work commences, and thereafter at such times as may be determined in the Risk Assessment.
- 5.10 The Contractor shall ensure that all subcontractors are informed regarding any hazard as stipulated in the Risk Assessment before any work commences, and thereafter at such times as may be determined in the Risk Assessment.
- 5.11 The Contractor shall ensure that all visitors to a construction site undergoes health and safety induction pertaining to the hazards prevalent on the site and shall be provided with the necessary personal protective equipment.

## **6. Fall Protection Plan**

- 6.1.1 In the event of the risk and hazard identification, as required in terms of clause 5.3 of this Specification, revealing risks relating to working from an elevated position the contractor shall cause the designation of a competent person, responsible for the preparation of a fall protection plan;
- 6.2 The Contractor shall implement, maintain and monitor the fall protection plan for the duration of Contract. The Contractor shall also take such steps to ensure the continued adherence to the fall protection plan.
- 6.3 The fall protection plan shall include:
- (a) A Risk Assessment of all work carried out from an elevated position;
  - (b) the procedures and methods to address all the identified risks per location;
  - (c) the evaluation of the employees physical and psychological fitness necessary to work at elevated positions;
  - (d) the training of employees working from elevated positions; and
  - (e) the procedure addressing the inspection, testing and maintenance of all fall protection equipment.

## **7. Hazards and Potential Hazardous Situations**

The Contractor and the Technical Officer shall immediately notify one another of any hazardous or potentially hazardous situations which may arise during performance of the Contract by the Contractor or any subcontractor and, in particular, of such hazards as may be caused by the design, execution and/or location and any other aspect pertaining to the contract work.

## **8. Health and Safety File**

- 8.1 The Contractor shall ensure that a health and safety file is opened and kept on site and shall include all documentation required as per the Act and applicable regulations, and made available to an inspector, the Technical Officer, or subcontractor upon request.
- 8.2 The Contractor shall ensure that a copy of the both his Health and Safety Plan as well as any subcontractor's Health and Safety Plan is available on request to an employee, inspector, contractor or the Technical Officer.
- 8.3 The Contractor shall hand over a consolidated health and safety file to the Technical Officer upon completion of the Construction Work and shall in addition to documentation mentioned in the Act and applicable Regulations include a record of all drawings, designs, materials used and other similar information concerning the completed structure.

"PREVIEW COPY ONLY"

**ANNEXURE 1**

**OCCUPATIONAL HEALTH AND SAFETY ACT, 1993**

**Regulation 3(1) of the Construction Regulations**

**NOTIFICATION OF CONSTRUCTION WORK**

- 
- 
- 1(a) Name and postal address of principal contractor:  
.....
  - (b) Name and tel. no of principal contractor's contact person:  
.....
  2. Principal contractor's compensation registration number: .....
  - 3.(a) Name and postal address of client:  
.....
  - (b) Name and tel no of client's contact person or agent:  
.....
  - 4.(a) Name and postal address of designer(s) for the project:  
.....
  - (b) Name and tel. no of designer(s) contact person:  
.....
  5. Name and telephone number of principal contractor's construction supervisor on site appointed in terms of regulation 6(1).  
.....
  6. Name/s of principal contractor's construction sub-ordinate supervisors on site appointed in terms of regulation 6(2). .....
  7. Exact physical address of the construction site or site office:  
.....
  8. Nature of the construction work:  
.....  
.....  
.....
  9. Expected commencement date: .....
  10. Expected completion date: .....

11. Estimated maximum number of persons on the construction site: \_\_\_\_\_

12. Planned number of contractors on the construction site accountable to the principle contractor:

\_\_\_\_\_

13. Name(s) of contractors already chosen.

\_\_\_\_\_  
\_\_\_\_\_  
\_\_\_\_\_  
\_\_\_\_\_  
\_\_\_\_\_  
\_\_\_\_\_

\_\_\_\_\_

Principal Contractor

Date

\_\_\_\_\_

Client:

Date

\* THIS DOCUMENT IS TO BE FORWARDED TO THE OFFICE OF THE DEPARTMENT OF LABOUR **PRIOR TO COMMENCEMENT** OF WORK ON SITE.

\* **ALL PRINCIPAL CONTRACTORS** THAT QUALIFY TO NOTIFY MUST DO SO EVEN IF ANOTHER PRINCIPAL CONTRACTOR ON THE SAME SITE HAD DONE SO PRIOR TO THE COMMENCEMENT OF WORK.

"PREVIEW COPY ONLY"

**ANNEXURE 2**

**(COMPANY LETTER HEAD)**

**OCCUPATIONAL HEALTH AND SAFETY ACT, 1993 (ACT 85 OF 1993) :**

**SECTION/REGULATION:** \_\_\_\_\_

**REQUIRED COMPETENCY:** \_\_\_\_\_

In terms of \_\_\_\_\_ I, \_\_\_\_\_  
representing the Employer) do hereby appoint \_\_\_\_\_

As the Competent Person on the premises at \_\_\_\_\_  
(physical address) to assist in compliance with the Act and the applicable Regulations.

Your designated area/s is/are as follows :-

\_\_\_\_\_  
\_\_\_\_\_  
\_\_\_\_\_

**Date :** \_\_\_\_\_

**Signature :-** \_\_\_\_\_

**Designation :-** \_\_\_\_\_

**ACCEPTANCE OF DESIGNATION**

I, \_\_\_\_\_ do hereby accept this Designation and acknowledge  
that I understand the requirements of this appointment.

**Date :** \_\_\_\_\_

**Signature :-** \_\_\_\_\_

**Designation :-** \_\_\_\_\_

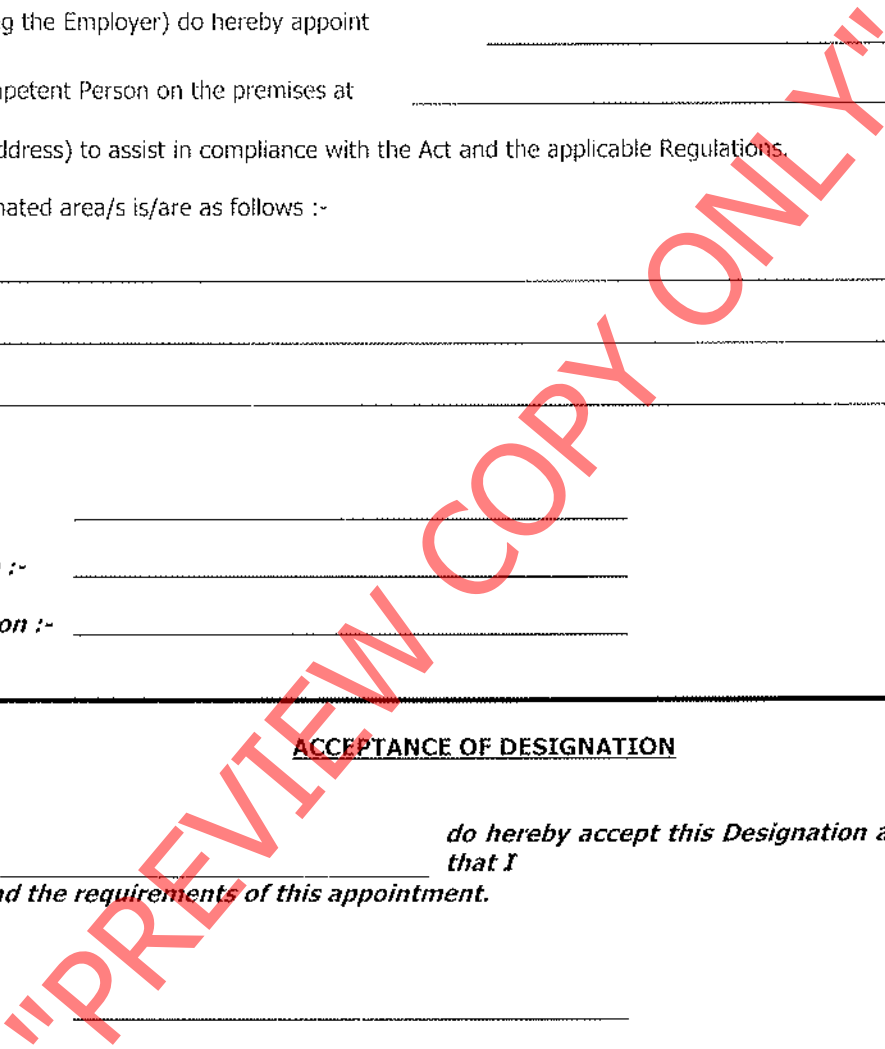

**ANNEXURE 3****(COMPANY LETTER HEAD)****OCCUPATIONAL HEALTH AND SAFETY ACT, 1993 (ACT 85 OF 1993) :****DECLARATION**

In terms of the above Act I, \_\_\_\_\_ am personally assuming the duties and obligations as Chief Executive Officer, defined in Section 1 of the Act and in terms of Section 16(1), I will, as far as is reasonably practicable, ensure that the duties and obligations of the Employer as contemplated in the above Act are properly discharged.

**Signature :-** \_\_\_\_\_

**Date :** \_\_\_\_\_

"PREVIEW COPY ONLY"

**ANNEXURE 4****(LETTER HEAD OF BUSINESS DIVISION OR UNIT OF TRANSNET LIMITED)****SITE ACCESS CERTIFICATE**

Access to : \_\_\_\_\_ (Area)  
 Name of Contractor/Builder :- \_\_\_\_\_  
 Contract/Order No.: \_\_\_\_\_

The contract works site/area described above are made available to you for the carrying out of associated works

In terms of your contract/order with  
 (company) \_\_\_\_\_

Kindly note that you are at all times responsible for the control and safety of the Works Site, and for persons under your control having access to the site.

As from the date hereof you will be responsible for compliance with the requirements of the Occupational Health and Safety Act, 1993 (Act 85 of 1993) as amended, and all conditions of the Contract pertaining to the site of the works as defined and demarcated in the contract documents including the plans of the site or work areas forming part thereof.

**Signed :** \_\_\_\_\_ **Date :** \_\_\_\_\_  
**TECHNICAL OFFICER**

**ACKNOWLEDGEMENT OF RECEIPT**

**Name of Contractor/Builder** \_\_\_\_\_ **I,**  
 :- \_\_\_\_\_  
 \_\_\_\_\_ **do hereby acknowledge and accept the**  
**duties**  
**and obligations in respect of the Safety of the site/area of Work in terms of the Occupational**  
**Health and Safety Act, Act 85 of 1993.**

**Name :** \_\_\_\_\_ **Designation** \_\_\_\_\_  
 \_\_\_\_\_

**Signature :** \_\_\_\_\_ **Date :** \_\_\_\_\_  
 \_\_\_\_\_

TRANSNET



Transnet SOC Limited Registration Number 1990/00900/06

---

## TRANSNET SPECIFICATION

---

# E7/1 - SPECIFICATION FOR GENERAL WORK AND WORKS ON, OVER, UNDER OR ADJACENT TO RAILWAY LINES AND NEAR HIGH VOLTAGE EQUIPMENT

---

(This specification shall be used in network operator contracts)

"PREVIEW COPY ONLY"

Circulation Not Restricted

© This document as a whole is protected by copyright. The information herein is the sole property of Transnet SOC Ltd. It may not be used, disclosed or reproduced in part or in whole in any manner whatsoever, except with the written permission of and in a manner permitted by the proprietors.

*(This page not to be issued with contract)*

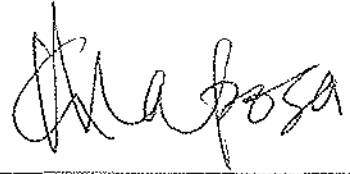

SPECIFICATION FOR GENERAL WORK AND WORKS ON, OVER, UNDER OR  
ADJACENT TO RAILWAY LINES AND NEAR HIGH VOLTAGE EQUIPMENT

Author: Project Manager  
Capital Program (Electrical) G. Maposa 

Approved: Senior Engineer  
Infra Engineering  
(Train Authorisation Systems) J. van den Berg 

“ Principal Engineer  
Infra Engineering (Track) M. Marutla 

“ Principal Engineer  
Infra Engineering (Structures) J. Homan 

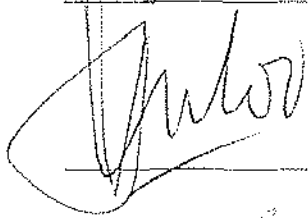
“ Principal Engineer  
Infra Engineering (Electrical) J. Vosloo 

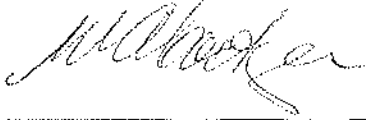
“ Principal Engineer  
Technology Management (Electrical) W. Coetzee 

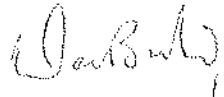
“ Chief Engineer  
Transport Telecoms D. Botha   
17 June 11

Authorised: Chief Engineer  
Infrastructure Engineering J. van Aardt   
2011/06/30

Date: May 2011

(This page not to be issued with contract)

TRANSNET



Transnet SOC Limited Registration Number 1990/00900/06

---

## TRANSNET SPECIFICATION

---

# E7/1 - SPECIFICATION FOR GENERAL WORK AND WORKS ON, OVER, UNDER OR ADJACENT TO RAILWAY LINES AND NEAR HIGH VOLTAGE EQUIPMENT

---

(This specification shall be used in network operator contracts)

"PREVIEW COPY ONLY"

Circulation Not Restricted

© This document as a whole is protected by copyright. The information herein is the sole property of Transnet SOC Ltd. It may not be used, disclosed or reproduced in part or in whole in any manner whatsoever, except with the written permission of and in a manner permitted by the proprietors.

## CONTENTS

<u>CLAUSE</u>	<u>HEADING</u>	<u>PAGE</u>
1.0	SCOPE	3
2.0	DEFINITIONS	3
<b>PART A - GENERAL SPECIFICATION</b>		
3.0	AUTHORITY OF OFFICERS OF TRANSNET	4
4.0	CONTRACTOR'S REPRESENTATIVES AND STAFF	4
5.0	OCCUPATIONS AND WORK PERMITS	4
6.0	SPEED RESTRICTIONS AND PROTECTION	5
7.0	ROADS ON THE NETWORK OPERATOR'S PROPERTY	5
8.0	CLEARANCES	5
9.0	STACKING OF MATERIAL	5
10.0	EXCAVATION, SHORING, DEWATERING AND DRAINAGE	5
11.0	FALSEWORK FOR STRUCTURES	6
12.0	PILING	6
13.0	UNDERGROUND SERVICES	6
14.0	BLASTING AND USE OF EXPLOSIVES	6
15.0	RAIL TROLLEYS	7
16.0	SIGNAL TRACK CIRCUITS	7
17.0	PENALTY FOR DELAYS TO TRAINS	7
18.0	SURVEY BEACONS AND PEGS	7
19.0	TEMPORARY LEVEL CROSSINGS	8
20.0	COMPLETION OF THE WORKS	8
21.0	PROTECTION OF PERSONS AND PROPERTY	9
22.0	INTERFERENCE WITH THE NETWORK OPERATOR'S ASSETS AND WORK ON OPEN LINES	10
23.0	ACCESS, RIGHTS-OF-WAY AND CAMPSITES	10
24.0	SUPERVISION	10
25.0	HOUSING OF EMPLOYEES	10
26.0	OPTICAL FIBRE CABLE ROUTES	10
<b>PART B - ADDITIONAL SPECIFICATION FOR WORK NEAR HIGH-VOLTAGE ELECTRICAL EQUIPMENT</b>		
27.0	GENERAL	11
28.0	WORK ON BUILDINGS OR FIXED STRUCTURES	11
29.0	WORK DONE ON OR OUTSIDE OF ROLLING STOCK, INCLUDING LOADING AND UNLOADING	11
30.0	USE OF EQUIPMENT	12
31.0	CARRYING AND HANDLING MATERIAL AND EQUIPMENT	12
32.0	PRECAUTIONS TO BE TAKEN WHEN ERECTING OR REMOVING POLES, ANTENNAE AND TREES ETC.	12
33.0	USE OF WATER	13
34.0	USE OF CONSTRUCTION PLANT	13
35.0	WORK PERFORMED UNDER DEAD CONDITIONS UNDER COVER OF A WORK PERMIT	13
36.0	TRACTION RETURN CIRCUITS IN RAILS	13
37.0	HIGH-VOLTAGE ELECTRICAL EQUIPMENT NOT MAINTAINED AND/OR OPERATED BY THE NETWORK OPERATOR	14

## 1.0 SCOPE

- 1.1 This specification covers the network operator's requirements for general work and works on, over, under or adjacent to railway lines and near high voltage equipment.

## 2.0 DEFINITIONS

The following definitions shall apply:

"Authorised Person" - A person whether an employee of the network operator or not, who has been specially authorised to undertake specific duties in terms of Transnet's publication Electrical Safety Instructions, and who holds a certificate or letter of authority to that effect.

"Barrier" Any device designed to restrict access to "live" high-voltage electrical equipment.

"Bond" - A short conductor installed to provide electrical continuity.

"Contractor" - Any person or organisation appointed by the network operator to carry out work on its behalf.

"Contract Supervisor" - The person or juristic person appointed by the network operator from time to time as the Contract Supervisor, to administer the Contractor's performance and execution of the Works according to the powers and rights held by and obligations placed upon the Contract Supervisor in terms of the Contract.

"Dead" - Isolated and earthed.

"Electrical Officer (Contracts)" - The person appointed in writing by the Project Manager in terms of this specification as the person who shall be consulted by the Contractor in all electrical matters to ensure that adequate safety precautions are taken by the Contractor.

"Executive Officer" - The person appointed by the network operator from time to time as the Executive Officer to act according to the rights and powers held by and obligations placed upon him in terms of the Contract.

"High-Voltage" - A voltage normally exceeding 1000 volts.

"Live" - A conductor is said to be "live" when it is at a potential different from that of the earth or any other conductor of the system of which it forms a part.

"Near" - To be in such a position that a person's body or the tools he is using or any equipment he is handling may come within 3 metres of "live" exposed high-voltage electrical equipment.

"Occupation" - An authorisation granted by the network operator for work to be carried out under specified conditions on, over, under or adjacent to railway lines.

"Occupation Between Trains" - An occupation during an interval between successive trains.

"Optical Fibre Cable" - Buried or suspended composite cable containing optical fibres used in:

- telecommunication networks for transmission of digital information and
- safety sensitive train operations systems.

"Project Manager" - As defined in the special conditions of the contract. The person or juristic person appointed by the network operator from time to time as the Project Manager, to administer the Contract according to the powers and rights held by and obligations placed upon him in terms of the Contract.

"Responsible Representative" - The responsible person in charge, appointed by a contractor, who has undergone specific training (and holds a certificate) to supervise (general or direct) staff under his control who perform general work or to work on, over, under or adjacent to railway lines and in the vicinity of high-voltage electrical equipment.

"Total Occupation" - An occupation for a period when trains are not to traverse the section of line covered by the occupation.

"Work on" - Work undertaken on or so close to the equipment that the specified working clearances to the "live" equipment cannot be maintained.

"Work Permit" - A combined written application and authority to proceed with work on or near dead electrical equipment.

"Works" - The contractual intent for the work to be done as defined in the contract at a defined work site.

---

**PART A - GENERAL SPECIFICATION****3.0 AUTHORITY OF OFFICERS OF TRANSNET**

- 3.1 The Contractor shall co-operate with the officers of the network operator and shall comply with all instructions issued and restrictions imposed with respect to the Works which bear on the existence and operation of the network operator's railway lines and high-voltage equipment.
- 3.2 Without limiting the generality of the provisions of clause 3.1, any duly authorised representative of the network operator, having identified himself, may stop the work if, in his opinion, the safe passage of trains or the safety of the network operator's assets or any person is affected. **CONSIDERATIONS OF SAFETY SHALL TAKE PRECEDENCE OVER ALL OTHER CONSIDERATIONS.**

**4.0 CONTRACTOR'S REPRESENTATIVES AND STAFF**

- 4.1 The Contractor shall nominate Responsible Representatives of whom at least one shall be available at any hour for call-out in cases of emergency. The Contractor shall provide the Contract Supervisor with the names, addresses and telephone numbers of the representatives.
- 4.2 The Contractor guarantees that he has satisfied himself that the Responsible Representative is fully conversant with this specification and that he shall comply with all his obligations in respect thereof.
- 4.3 The Contractor shall ensure that all contractor staff receives relevant awareness, educational and competence training regarding safety as prescribed.

**5.0 OCCUPATIONS AND WORK PERMITS**

- 5.1 Work to be done during total occupation or during an occupation between trains or under a work permit shall be done in a manner decided by the Contract Supervisor and at times to suit the network operator requirements.
- 5.2 The Contractor shall organise the Works in a manner which will minimise the number and duration of occupations and work permits required.
- 5.3 The network operator will not be liable for any financial or other loss suffered by the Contractor arising from his failure to complete any work scheduled during the period of an occupation or work permit.
- 5.4 The Contractor shall submit to the Contract Supervisor, in writing, requests for occupations or work permits together with details of the work to be undertaken, at least 21 days before they are required. The network operator does not undertake to grant an occupation or work permit for any particular date, time or duration.
- 5.5 The network operator reserves the right to cancel any occupation or work permit at any time before or during the period of occupation or work permit. If, due to cancellation or change in date or time, the Contractor is not permitted to start work under conditions of total occupation or work permit at the time arranged, all costs caused by the cancellation shall be born by the Contractor except as provided for in clauses 5.6 to 5.8.
- 5.6 When the Contractor is notified less than 2 hours before the scheduled starting time that the occupation or work permit is cancelled, he may claim reimbursement of his direct financial losses caused by the loss of working time up to the time his labour and plant are employed on other work, but not exceeding the period of the cancelled occupation or work permit.
- 5.7 When the Contractor is notified less than 2 hours before the scheduled starting time, or during an occupation or work permit, that the duration of the occupation or work permit is reduced, he may claim reimbursement of his direct financial losses caused by the loss of working time due to the reduced duration of the occupation or work permit.
- 5.8 Reimbursement of the Contractor for any loss of working time in terms of clause 5.6 and 5.7, shall be subject to his claims being submitted within 14 days of the event with full details of labour and plant involved, and provided that the Contract Supervisor certifies that no other work on which the labour and plant could be employed was immediately available.
- 5.9 Before starting any work for which an occupation has been arranged, the Contractor shall obtain from the Contract Supervisor written confirmation of the date, time and duration of the occupation.
- 5.10 Before starting any work for which a work permit has been arranged, the Responsible Representative shall read and sign portion C of the Work Permit, signifying that he is aware of the work boundaries within which work may be undertaken. After the work for which the permit was granted has been completed, or when the

work permit is due to be terminated, or if the permit is cancelled after the start, the same person who signed portion C shall sign portion D of the Work Permit, thereby acknowledging that he is aware that the electrical equipment is to be made "live". The Contractor shall advise all his workmen accordingly.

## 6.0 SPEED RESTRICTIONS AND PROTECTION

- 6.1 When speed restrictions are imposed by the network operator because of the Contractor's activities, the Contractor shall organise and carry out his work so as to permit the removal of the restrictions as soon as possible.
- 6.2 When the Contract Supervisor considers protection to be necessary the Contractor shall, unless otherwise agreed, provide all protection including flagmen, other personnel and all equipment for the protection of the network operator's and the Contractor's personnel and assets, the public and including trains.
- 6.2.1 The network operator will provide training free of charge of the Contractor's flagmen and other personnel performing protection duties. The Contractor shall consult with the Contract Supervisor, whenever he considers that protection will be necessary, taking into account the minimum permissible clearances set out in the Manual for Track Maintenance (Document no. BBB0481):
- Drawing no. BE-97 Sheet 1: Horizontal Clearances: 1065mm gauge (Annexure 1 sheet 1)
  - Drawing no. BE-97 Sheet 2: Vertical Clearances: 1065mm gauge (Annexure 1 sheet 2)
  - Drawing no. BE-97 Sheet 3: Clearances: Platform (Annexure 1 sheet 3)
  - Drawing no. BE-97 Sheet 5: Clearances: 610mm Gauge (Annexure 1 sheet 5)
- 6.3 The Contractor shall appoint a Responsible Representative to receive and transmit any instruction which may be given by the network operator personnel providing protection.

## 7.0 ROADS AND ROADS ON THE NETWORK OPERATOR'S PROPERTY

- 7.1 The Contractor shall take every reasonable precaution to prevent damage to any roads or bridges used to obtain access to the site, and shall select routes, use vehicles, and restrict loads so that any extraordinary traffic as may arise from the moving of plant or material to or from the site shall be limited as far as is reasonably possible.
- 7.2 The Contractor shall not occupy or interfere in any way with the free use of any public or private road, right-of-way, path or street unless the Contract Supervisor has obtained the approval of the road authority concerned.

## 8.0 CLEARANCES

- 8.1 No temporary works shall encroach on the appropriate minimum clearances set out in the Manual for Track Maintenance (Document no. BBB0481):
- Drawing no. BE-97 Sheet 1: Horizontal Clearances: 1065mm gauge (Annexure 1 sheet 1)
  - Drawing no. BE-97 Sheet 2: Vertical Clearances: 1065mm gauge (Annexure 1 sheet 2)
  - Drawing no. BE-97 Sheet 3: Clearances: Platform (Annexure 1 sheet 3)
  - Drawing no. BE-97 Sheet 5: Clearances: 610mm Gauge (Annexure 1 sheet 5)

## 9.0 STACKING OF MATERIAL

- 9.1 The Contractor shall not stack any material closer than 3m from the centre line of any railway line without prior approval of the Contract Supervisor.

## 10.0 EXCAVATION, SHORING, DEWATERING AND DRAINAGE

- 10.1 Unless otherwise approved by the Contract Supervisor any excavation adjacent to a railway line shall not encroach on the hatched area shown in Figure 1.

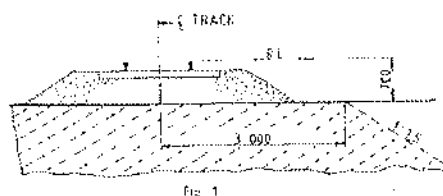

- 10.2 The Contractor shall provide, at his own cost any shoring, dewatering or drainage of any excavation unless otherwise stipulated elsewhere in the Contract.
- 10.3 Where required by the Contract Supervisor, drawings of shoring for any excavation under or adjacent to a railway line shall be submitted and permission to proceed, obtained before the excavation is commenced.
- 10.4 The Contractor shall prevent ingress of water to the excavation but where water does enter, he shall dispose of it as directed by the Contract Supervisor.
- 10.5 The Contractor shall not block, obstruct or damage any existing drains either above or below ground level unless he has made adequate prior arrangements to deal with drainage.
- 11.0 FALSEWORK FOR STRUCTURES**
- 11.1 Drawings of falsework for the construction of any structure over, under or adjacent to any railway line shall be submitted to the Contract Supervisor and his permission to proceed obtained before the falsework is erected. Each drawing shall be given a title and a distinguishing number and shall be signed by a registered professional engineer certifying that he has checked the design of the falsework and that the drawings are correct and in accordance with the design.
- 11.2 After the falsework has been erected and before any load is applied, the Contractor shall submit to the Contract Supervisor a certificate signed by a registered professional engineer certifying that he has checked the falsework and that it has been erected in accordance with the drawings. Titles and numbers of the drawings shall be stated in the certificate. Notwithstanding permission given by the Contract Supervisor to proceed, the Contractor shall be entirely responsible for the safety and adequacy of the falsework.
- 12.0 PILING**
- 12.1 The Contract Supervisor will specify the conditions under which piles may be installed on the network operator's property.
- 13.0 UNDERGROUND SERVICES**
- 13.1 No pegs or stakes shall be driven or any excavation made before the Contractor has established that there are no underground services which may be damaged thereby.
- 13.2 Any damage shall be reported immediately to the Contract Supervisor, or to the official in charge at the nearest station, or to the traffic controller in the case of centralised traffic control.
- 14.0 BLASTING AND USE OF EXPLOSIVES**
- 14.1 When blasting within 500m of a railway line, the Contractor shall observe the requirements stipulated in this specification.
- 14.2 No blasting shall be carried out except with the prior written permission of the Contract Supervisor and under such conditions as he may impose.
- 14.3 On electrified lines the Contractor shall also obtain the permission of the Electrical Officer (Contracts) before blasting, and shall give at least 21 days notice of his intention to blast. No blasting shall be done in the vicinity of electrified lines unless a member of the network operator's electrical personnel is present.
- 14.4 The Contractor shall arrange for the supply, transport storage and use of explosives.
- 14.5 The Contractor shall have labour, tools and plant, to the satisfaction of the Contract Supervisor, available on the site to clear immediately any stones or debris deposited on the track or formation by blasting, and to repair any damage to the track or formation immediately after blasting. Repairs to the track shall be carried out only under the supervision of a duly authorised representative of the network operator.
- 14.6 The Contractor shall notify the Contract Supervisor of his intention to blast at least 21 days before the commencement of any blasting operations.
- 14.7 Before any blasting is undertaken, the Contractor and the Contract Supervisor shall jointly examine and measure up any buildings, houses or structures in the vicinity of the proposed blasting to establish the extent of any existing cracking or damage to such structures, etc. The Contractor, shall, subject to the provisions stipulated in the Contract Insurance Policy, make good any deterioration of such buildings, houses, or structures, which, in the opinion of the Contract Supervisor, was directly caused by the blasting.
- 14.8 After completion of the blasting the Contractor shall obtain a written clearance from each landowner in

the vicinity of the blasting operations to the effect that all claims for compensation in respect of damage caused by the blasting operations to their respective properties, have been settled.

14.9 The Contractor shall provide proof that he has complied with the provisions of clauses 10.17.1 to 10.17.4 of the Explosives Regulations (Act 26 of 1956 as amended).

14.10 Blasting within 500m of a railway line will only be permitted during intervals between trains. A person appointed by the Contract Supervisor, assisted by flagmen with the necessary protective equipment, will be in communication with the controlling railway station.

Only this person will be authorised to give the Contractor permission to blast, and the Contractor shall obey his instructions implicitly regarding the time during which blasting may take place.

14.11 The flagmen described in clause 14.10, where provided by the network operator, are for the protection of trains and the network operator's property only, and their presence does not relieve the Contractor in any manner of his responsibilities in terms of Explosives Act or Regulations, or any obligation in terms of this Contract.

14.12 The person described in clause 14.10 will record in a book provided and retained by the network operator, the dates and times:-

(i) when each request is made by him to the controlling station for permission to blast;

(ii) when blasting may take place;

(iii) when blasting actually takes place; and

(iv) when he advises the controlling station that the line is safe for the passage of trains.

14.13 Before each blast the Contractor shall record in the same book, the details of the blast to be carried out. The person appointed by the Contract Supervisor and the person who will do the blasting shall both sign the book whenever an entry described in clause 14.12 is made.

## 15.0 RAIL TROLLEYS

15.1 The use of rail trolleys or trestle trolleys on a railway line for working on high voltage equipment will be permitted only if approved by the Contract Supervisor and under the conditions stipulated by him.

15.2 All costs in connection with trolley working and any train protection services requested by the Contractor shall, be borne by the Contractor, unless otherwise agreed.

## 16.0 SIGNAL TRACK CIRCUITS

16.1 Where signal track circuits are installed, the Contractor shall ensure that no material capable of conducting an electrical current makes contact between rails of railway line/lines.

16.2 No signal connections on track-circuited tracks shall be severed without the Contract Supervisor's knowledge and consent.

## 17.0 PENALTY FOR DELAYS TO TRAINS

17.1 If any trains are delayed by the Contractor and the Contract Supervisor is satisfied that the delay was avoidable, a penalty will be imposed on the Contractor as stipulated in the contract, for the period and number of trains delayed.

## 18.0 SURVEY BEACONS AND PEGS

18.1 The Contractor shall not on any account move or damage any beacon, bench mark, reference mark, signal or trigonometrical station in the execution of the Works without the written approval of the Contract Supervisor.

Should the Contractor be responsible for any such occurrence, he shall report the circumstances to the Contract Supervisor who will arrange with the Director-General of Surveys for replacement of the beacon or mark at the cost of the Contractor.

18.2 The Contractor shall not move or damage any cadastral or mining beacon without the written approval of the Contract Supervisor and before it has been referenced by a registered land surveyor. Any old boundary beacon, which becomes an internal beacon on creation of new boundaries, shall not be moved without the written approval of the Contract Supervisor.



Should the Contractor move or damage any cadastral or mining beacon without authority, he shall be responsible for having it replaced, at his cost, by a land surveyor.

- 18.3 The Contractor shall preserve all pegs and bench marks. Such survey points shall not be removed without the written approval of the Contract Supervisor. Should any peg or benchmark be removed without authority, the Contract Supervisor will arrange for its replacement and the cost will be recovered from the Contractor. No claim will be considered for delay in replacing any such peg or bench mark. Each peg replaced shall be checked by the Contractor.
- 18.4 Where a new boundary has been established, beacons on the fence line shall not be disturbed, and fence posts or anchors may not be placed or excavations made within 0,6 m of any beacon without the prior written approval of the Contract Supervisor.

## 19.0 TEMPORARY LEVEL CROSSINGS

- 19.1 The Contract Supervisor may, on request of the Contractor, and if necessary for the purpose of execution of the Works, permit the construction of a temporary level crossing over a railway a line at a position approved by the Contract Supervisor and at the Contractor's cost. The period for which the temporary level crossing is permitted will be at the discretion of the Contract Supervisor.
- 19.2 The Contractor will provide protection and supervise the construction of the road over the track(s) and within the railway servitude at the level crossing, as well as the erection of all road signs and height gauges. All cost to be borne by the applicant.
- The Contractor shall exercise extreme caution in carrying out this work, especially in respect of damage to tracks, services, overhead power and communications routes and prevent contact with "live" overhead electrical equipment.
- Unless otherwise agreed, the Contractor will provide the service deviations or alterations to the network operator's track-, structure-, drainage-, electrical-, telecommunications- and train authorisation systems to accommodate the level crossing.
- 19.3 The Contractor shall take all necessary steps including the provision of gates, locks and, where necessary, watchmen to restrict the use of the temporary level crossing to himself and his employees, his subcontractors and their employees, the staff of the network operator and to such other persons as the Contract Supervisor may permit and of whose identity the Contractor will be advised. If so ordered by the Contract Supervisor, the Contractor shall provide persons to control road traffic using the temporary level crossing. Such persons shall stop all road traffic when any approaching train is within seven hundred and fifty (750) metres of the temporary level crossing, and shall not allow road traffic to proceed over it until the lines are clear.
- 19.4 The Contractor shall maintain the temporary level crossing within the railway servitude in good condition for the period it is in use. A temporary agreement with the road authority to be concluded for the maintenance of the level crossing outside the railway servitude.
- 19.5 When the temporary level crossing is no longer required by the Contractor, or permitted by the network operator, the Contractor shall at his own cost remove it and restore the site and the network operator's track-, structure-, drainage-, electrical-, telecommunications- and train authorisation systems to its original condition. Work over the tracks and within the railway servitude will be supervised by the network operator.

## 20.0 COMPLETION OF THE WORKS

- 20.1 On completion of the works, the Contractor shall remove all the remaining construction plant and material from the site, other than material which is the property of the network operator, and leave the site in a clean, neat and tidy condition. If material and plant is required for the liability and maintenance period the Contract supervisor must authorise it's retention on site.

## 21.0 PROTECTION OF PERSONS AND PROPERTY

- 21.1 The Contractor shall provide and maintain all lights, guards, barriers, fencing and watchmen when and where necessary or as required by the Contract Supervisor or by any statutory authority, for the protection of the Works and for the safety and convenience of the public.

Red, yellow, green or blue lights may not be used by the Contractor as they can be mistaken for signals. Red, yellow, green or white flags shall only be used for protection by the Contractor. Within the precincts of a port the Contractor shall obtain the permission of the Port Captain before installing any light.

- 21.2 The Contractor shall take all the requisite measures and precautions during the course of the Works to:
- (i) protect the public and property of the public,
  - (ii) protect the property and workmen of both the network operator and the Contractor,
  - (iii) avoid damage to and prevent trespass on adjoining properties, and
  - (iv) ensure compliance with any instruction issued by the Contract Supervisor or other authorised person, and with any stipulation embodied in the contract documents which affects the safety of any person or thing.
- 21.3 The network operator will provide, at its own cost, protection for the safe working of trains during such operations as the Contract Supervisor may consider necessary. Protection by the network operator for any purpose whatsoever, does not absolve the Contractor of his responsibilities in terms of the Contract.
- 21.4 The Contractor shall take all precautions and appoint guards, watchmen and compound managers for prevention of disorder among and misconduct by the persons employed on the Works and by any other persons, whether employees or not, on the work site and for the preservation of the peace and protection of persons and property in the direct neighbourhood. Any relocation of camps because of disorder shall be at the Contractor's expense.
- 21.5 All operations necessary for the execution of the Works, including the provision of any temporary work and camping sites, shall be carried out so as not to cause veldt fires, ground and environmental pollution, soil erosion or restriction of or interference with streams, furrows, drains and water supplies.
- If the original surface of the ground is disturbed in connection with the Works, it shall be made good by the Contractor to the satisfaction of the land owner, occupier or responsible authority.
- 21.6 The Contractor shall take all reasonable steps to minimise noise and disturbance when carrying out the Works, including work permitted outside normal working hours.
- 21.7 Dumping of waste or excess materials by the Contractor shall, in urban areas, be done under the direction and control of, and at sites made available by the local authority. Dumping outside local authority boundaries shall be done only with the express permission and under the direction and control of the Contract Supervisor.
- 21.8 The Contractor shall comply with environmental protection measures and specifications stipulated by the Contract Supervisor and/or local and environmental authorities.
- 22.0 INTERFERENCE WITH THE NETWORK OPERATOR'S ASSETS AND WORK ON OPEN LINES**
- 22.1 The Contractor shall not interfere in any manner whatsoever with an open line, nor shall he carry out any work or perform any act which affects the security, use or safety of an open line except with the authority of the Contract Supervisor and in the presence of a duly authorised representative of the network operator.
- 22.2 The Contractor shall not carry out any work or operate any plant, or place any material whatsoever nearer than three metres from the centre line of any open line except with the written permission of the Contract Supervisor and subject to such conditions as he may impose.
- 22.3 Care must be taken not to interfere with or damage any services such as overhead wire routes, cables or pipes and optical fibre cable, except as provided for the work specified. The Contractor will be held responsible for any damage to or interruption of such services arising from any act or omission on his part or of any of his employees, or persons engaged by him on the Works. The cost of repairing, replacing or restoring the services, as well as all other costs arising from any damage to services, shall be borne by, and will be recovered from the Contractor.
- 22.4 Authority granted by the Contract Supervisor and the presence of an authorised representative of the network operator in terms hereof, shall not relieve the Contractor of his duty to comply with this specification.
- 23.0 ACCESS, RIGHTS-OF-WAY AND CAMPSITES**
- 23.1 Where entry onto the network operator's property is restricted, permission to enter will be given only for the purpose of carrying out the Works and will be subject to the terms and conditions laid down by the network operator.
- 23.2 The Contractor shall arrange for campsites, workplaces and access thereto as well as for any right-of-

way over private property to the site of the Works, and for access within the boundaries of the network operator's property. The owners of private property to be traversed shall be approached and treated with tact and courtesy by the Contractor, who shall, if necessary, obtain a letter of introduction to such property owners from the Contract Supervisor.

The Contractor shall be responsible for the closing of all gates on roads and tracks used by him or his employees. Except with the prior approval of the Contract Supervisor and the owner or occupier of any private land to be traversed, the Contractor shall not cut, lower, damage, remove or otherwise interfere with any fence or gate which is either on the network operator's property or on private property and which restricts access to the Works. Where such approval has been given, the Contractor shall prevent entry of animals or unauthorised persons onto the network operator's or private property, and shall make the fences safe against trespass at the close of each day's work.

23.3 The Contractor shall take all reasonable steps to confine the movement of vehicles and plant to the approved right-of-way to minimise damage to property, crops and natural vegetation.

23.4 When access is no longer required, and before completion of the Works, the Contractor shall repair, restore or replace any fence or gate damaged during execution of the Works to the satisfaction of the Contract Supervisor and shall furnish the Contract Supervisor with a certificate signed by the owner and occupier of land over which he has gained access to a campsite, workplace and the Works, certifying that the owner and occupier have no claim against the Contractor or the network operator arising from the Contractor's use of the land. Should the Contractor be unable to obtain the required certificate, he shall report the circumstances to the Contract Supervisor.

#### **24.0 SUPERVISION**

24.1 The Contract Supervisor will provide overall technical superintendence of the Works, and may direct the Contractor in terms of the provisions of the Contract or in respect of any measures which the Contract Supervisor may require for the operations of the network operator, the safety of trains, property and workmen of the network operator, and for the safety of other property and persons. The Contractor shall carry out the directions of the Contract Supervisor. The superintendence exercised by the Contract Supervisor, including any agreement, approval, refusal or withdrawal of any approval given, shall not relieve the Contractor of any of his duties and liabilities under the Contract, and shall not imply any assumption by the network operator or by the Contract Supervisor of the legal and other responsibilities of the Contractor in carrying out the Works.

24.2 The Contract Supervisor may delegate to any deputy or other person, any of his duties or functions under the Contract. On receiving notice in writing of such delegation, the Contractor shall recognise and obey the deputy or person to whom any such duties or functions have been delegated as if he were the Contract Supervisor.

24.3 The Contractor shall exercise supervision over the Works at all times when work is performed or shall be represented by an agent having full power and authority to act on behalf of the Contractor. Such agent shall be competent and responsible, and have adequate experience in carrying out work of a similar nature to the Works, and shall exercise personal supervision on behalf of the Contractor. The Contract Supervisor shall be notified in writing of such appointment which will be subject to his approval.

24.4 The Contractor or his duly authorised agent shall be available on the site at all times while the Works are in progress to receive the orders and directions of the Contract Supervisor.

#### **25.0 HOUSING OF EMPLOYEES**

25.1 The Contractor shall, where necessary, make his own arrangements for suitable housing of his employees. Where temporary housing is permitted by the Contract Supervisor on any part of the site, the Contractor shall provide suitable sanitation, lighting and potable water supplies in terms of the requirements of the local authority or the current network operator's specification; Minimum Communal Health Requirements in Areas outside the Jurisdiction of a Local Authority - E.4B, as applicable.

25.2 Fouling the area inside or outside the network operator's boundaries shall be prevented. The Contractor will be called upon by the Contract Supervisor to dispose of any foul or waste matter generated by the Contractor.

#### **26.0 OPTICAL FIBRE CABLE ROUTES**

26.1 The Contractor shall not handle, impact, move or deviate any optical fibre cable without prior approval.

26.2 Works that in any way affect the optical fibre cable requires prior approval from the Contract Supervisor

---

who will determine the work method and procedures to be followed.

"PREVIEW COPY ONLY"

---

**PART B - SPECIFICATION FOR WORK NEAR HIGH-VOLTAGE ELECTRICAL EQUIPMENT**
**27.0 GENERAL**

27.1 This specification is based on the contents of Transnet's publication ELECTRICAL SAFETY INSTRUCTIONS, as amended, a copy of which will be made available on loan to the Contractor for the duration of the contract.

These instructions apply to all work near "live" high-voltage equipment maintained and/or operated by the network operator, and the onus rests on the Contractor to ensure that he obtains a copy.

27.2 This specification must be read in conjunction with and not in lieu of the Electrical Safety Instructions.

27.3 The Contractor's attention is drawn in particular to the contents of Part I, Sections 1 and 2 of the Electrical Safety Instructions.

27.4 The Electrical Safety Instructions cover the minimum safety precautions which must be taken to ensure safe working on or near high-voltage electrical equipment, and must be observed at all times. Should additional safety measures be considered necessary because of peculiar local conditions, these may be ordered by and at the discretion of the Electrical Officer (Contracts).

27.5 The Contractor shall obtain the approval of the Electrical Officer (Contracts) before any work is done which causes or could cause any portion of a person's body or the tools he is using or any equipment he is handling, to come within 3 metres of any "live" high-voltage equipment.

27.6 The Contractor shall regard all high-voltage equipment as "live" unless a work permit is in force.

27.7 Safety precautions taken or barriers erected shall comply with the requirements of the Electrical Officer (Contracts), and shall be approved by him before the work to be protected is undertaken by the Contractor. The Contractor shall unless otherwise agreed, bear the cost of the provision of the barriers and other safety precautions required, including the attendance of the network operator's staff where this is necessary.

27.8 No barrier shall be removed unless authorised by the Electrical Officer (Contracts).

**28.0 WORK ON BUILDINGS OR FIXED STRUCTURES**

28.1 Before any work is carried out or measurements are taken on any part of a building, fixed structure or earthworks of any kind above ground level situated within 3 metres of "live" high-voltage equipment, the Electrical Officer (Contracts) shall be consulted to ascertain the conditions under which the work may be carried out.

28.2 No barrier erected to comply with the requirements of the Electrical Officer (Contracts) shall be used as temporary staging or shuttering for any part of the Works.

28.3 The shuttering for bridge piers, abutments, retaining walls or parapets adjacent to or over any track may be permitted to serve as a barrier, provided that it extends at least 2,5 metres above any working level in the case of piers, abutments and retaining walls and 1,5 metres above any working level in the case of parapets.

**29.0 WORK DONE ON OR OUTSIDE OF ROLLING STOCK, INCLUDING LOADING OR UNLOADING**

29.1 No person may stand, climb or work, whilst on any platform, surface or foothold:

29.1.1 higher than the normal unrestricted access way, namely -

29.1.1.1 external walkways on diesel, steam and electric locomotives, steam heat vans, etc. and

29.1.1.2 walkways between coaches and locomotives.

29.1.2 of restricted access ways in terms of the Electrical Safety Instructions namely -

29.1.2.1 the floor level of open wagons

29.1.2.2 external walkways or decks of road-rail vehicles, on-track maintenance machines and material trains.

29.1.3 Unauthorised staff working on these platforms must be directly supervised by duly authorised persons in terms of clause 607.1.3 of the Electrical Safety Instructions. These persons must attend the relevant electrical safety module training. A letter of training must then be issued by an accredited training authority. A Category C Certificate of Authority must be obtained from the

local depot examining officer.

- 29.2 When in the above positions no person may raise his hands or any equipment he is handling above his head.
- 29.3 In cases where the Contractor operates his own rail mounted equipment, he shall arrange for the walkways on this plant to be inspected by the Electrical Officer (Contracts) and approved, before commencement of work.
- 29.4 The handling of long lengths of material such as metal pipes, reinforcing bars, etc should be avoided, but if essential they shall be handled as nearly as possible in a horizontal position below head height.
- 29.5 The Responsible Representative shall warn all persons under his control of the danger of being near "live" high-voltage equipment, and shall ensure that the warning is fully understood.
- 29.6 Where the conditions in clauses 30.1 to 30.4 cannot be observed the Electrical Officer (Contracts), shall be notified. He will arrange for suitable Safety measures to be taken. The Electrical Officer (Contracts), may in his discretion and in appropriate circumstances, arrange for a suitable employee of the Contractor to be specially trained by the network operator and at the Contractor's cost, as an Authorised Person to work closer than 3 metres from "live" overhead conductors and under such conditions as may be imposed by the senior responsible electrical engineer of the network operator.

### **30.0 USE OF EQUIPMENT**

#### **30.1 Measuring Tapes and Devices**

- 30.1.1 Measuring tapes may be used near "live" high-voltage equipment provided that no part of any tape or a person's body comes within 3 metres of the "live" equipment.
- 30.1.2 In windy conditions the distance shall be increased to ensure that if the tape should fall it will not be blown nearer than 3 metres from the "live" high-voltage equipment.
- 30.1.3 Special measuring devices longer than 2 metres such as survey sticks and rods may be used if these are of non-conducting material and approved by the responsible Electrical Engineer of the network operator, but these devices must not be used within 3 metres of "live" high-voltage equipment in rainy or wet conditions.
- 30.1.4 The assistance of the Electrical Officer (Contracts) shall be requested when measurements within the limits defined in clauses 31.1.1 to 31.1.3 are required.
- 30.1.5 The restrictions described in 31.1.1 to 31.1.3 do not apply on a bridge deck between permanent parapets nor in other situations where a barrier effectively prevents contact with the "live" high-voltage equipment.

#### **30.2 Portable Ladders**

- 30.2.1 Any type of portable ladder longer than 2 metres may only be used near "live" high-voltage equipment under the direct supervision of the Responsible Representative. He shall ensure that the ladder is always used in such a manner that the distance from the base of the ladder to any "live" high-voltage equipment is greater than the fully extended length of the ladder plus 3 metres. Where these conditions cannot be observed, the Electrical Officer (Contracts) shall be advised, and he will arrange for suitable safety measures to be taken.

### **31.0 CARRYING AND HANDLING MATERIAL AND EQUIPMENT**

- 31.1 Pipes, scaffolding, iron sheets, reinforcing bars and other material which exceeds 2 metres in length shall be carried completely below head height near "live" high-voltage equipment. For maximum safety such material should be carried by two or more persons so as to maintain it as nearly as possible in a horizontal position. The utmost care must be taken to ensure that no part of the material comes within 3 metres of any "live" high-voltage equipment.
- 31.2 Long lengths of wire or cable shall never be run out in conditions where a part of a wire or cable can come within 3 metres of any "live" high-voltage equipment unless the Electrical Officer (Contracts) has been advised and has approved appropriate safety precautions.
- 31.3 The presence of overhead power lines shall always be taken account of especially when communications lines or cables or aerial cables, stay wires, etc. are being erected above ground level.

### **32.0 PRECAUTIONS TO BE TAKEN WHEN ERECTING OR REMOVING POLES, ANTENNAE, TREES ETC.**

- 32.1 A pole may be handled for the purpose of erection or removal near high-voltage equipment under the following conditions:

(i) If the distance between the point at which the pole is to be erected or removed and the nearest "live" high-voltage equipment is more than the length of the pole plus 3 metres, the work shall be supervised by the Responsible Representative.

(ii) If the distance described in (i) is less than the length of the pole plus 3 metres, the Electrical Officer (Contracts) shall be consulted to arrange for an Authorised Person to supervise the work and to ensure that the pole is earthed where possible. The pole shall be kept in contact with the point of erection, and adequate precautions shall be taken to prevent contact with "live" high-voltage equipment.

32.2 The cost of supervision by an Authorised Person and the provision of earthing shall, unless otherwise agreed, be borne by the Contractor.

32.3 The provisions of clauses 33.1 and 33.2 shall also apply to the erection or removal of columns, antennae, trees, posts, etc.

### 33.0 USE OF WATER

33.1 No water shall be used in the form of a jet if it can make contact with any "live" high-voltage equipment or with any person working on such equipment.

### 34.0 USE OF CONSTRUCTION PLANT

34.1 "Construction plant" entails all types of plant including cranes, piling frames, boring machines, excavators, draglines, dewatering equipment and road vehicles with or without lifting equipment.

34.2 When work is being undertaken in such a position that it is possible for construction plant or its load to come within 3 metres of "live" high-voltage equipment, the Electrical Officer (Contracts) shall be consulted. He will arrange for an Authorised Person to supervise the work and to ensure that the plant is adequately earthed. The Electrical Officer (Contracts) will decide whether further safety measures are necessary.

34.3 The cost of any supervision by an Authorised Person and the provision of earthing shall, unless otherwise agreed, be borne by the Contractor.

34.4 When loads are handled by cranes, non-metallic rope hand lines shall be used, affixed to such loads so as to prevent their swinging and coming within 3 metres of "live" high-voltage equipment.

34.5 Clauses 35.1 to 35.4 shall apply *mutatis mutandis* to the use of maintenance machines of any nature.

### 35.0 WORK PERFORMED UNDER DEAD CONDITIONS UNDER COVER OF A WORK PERMIT

35.1 If the Responsible Representative finds that the work cannot be done in safety with the high-voltage electrical equipment "live", he shall consult the Electrical Officer (Contracts) who will decide on the action to be taken.

35.2 If a work permit is issued the Responsible Representative shall-

(i) before commencement of work ensure that the limits within which work may be carried out have been explained to him by the Authorised Person who issued the permit to him, and that he fully understands these limits.

(ii) sign portion C of the permit before commencement of work;

(iii) explain to all persons under his control the limits within which work may be carried out, and ensure that they fully understand these limits;

(iv) care for the safety of all persons under his control whilst work is in progress; and

(v) withdraw all personnel under his control from the equipment on completion of the work before he signs portion D of the work permit.

### 36.0 TRACTION RETURN CIRCUITS IN RAILS

36.1 DANGEROUS CONDITIONS CAN BE CREATED BY REMOVING OR SEVERING ANY BOND.

36.2 Broken rails with an air gap between the ends, and joints at which fishplates are removed under "broken bond" conditions, are potentially lethal. The rails on either side of an air gap between rail ends on electrified lines shall not be touched simultaneously until rendered safe by the network operator personnel.

36.3 The Contractor shall not break any permanent bonds between rails or between rails and any structure. He shall give the Contract Supervisor at least 7 days written notice when removal of such bonds is necessary.

36.4 No work on the track which involves interference with the traction return rail circuit either by cutting or removing the rails, or by removal of bonds shall be done unless the Electrical Officer (Contracts) is consulted. He will take such precautions as may be necessary to ensure continuity of the return circuit before permitting the work to be commenced.

**37.0 HIGH-VOLTAGE ELECTRICAL EQUIPMENT NOT MAINTAINED AND/OR OPERATED BY THE NETWORK OPERATOR**

Where the work is undertaken on or near high-voltage electrical equipment which is not maintained and/or operated by the network operator, the Occupational Health and Safety Act No. 85 of 1993, and Regulations and Instructions, or the Mines Health and Safety Act (Act 29 of 1996), shall apply.

Such equipment includes:-

- (i) Eskom and municipal equipment;
- (ii) The Contractor's own power supplies; and
- (iii) Electrical equipment being installed but not yet taken over from the Contractor.

END

"PREVIEW COPY ONLY"



HORIZONTAL CLEARANCES :  
1 065mm TRACK GAUGE

ANNEXURE 1  
SHEET 1 of 5



RADIUS (m)	WITH CANT		NO CANT		WITH CANT	
	H (mm)	L (mm)	H & L	B (mm)	C (mm)	C (mm)
90	2 730	3 090	2 780	1 130	2 100	2 100
100	2 700	3 030	2 750	1 140	2 050	2 050
120	2 650	2 970	2 700	1 160	2 010	2 010
140	2 620	2 920	2 660	1 175	1 990	1 990
170	2 590	2 870	2 630	1 190	1 970	1 970
200	2 570	2 820	2 600	1 205	1 950	1 950
250	2 550	2 790	2 580	1 230	1 920	1 920
300	2 540	2 760	2 560	1 250	1 900	1 900
350	2 530	2 730	2 540	1 270	1 890	1 890
400	2 520	2 710	2 530	1 290	1 875	1 875
500	2 510	2 680	2 520	1 320	1 850	1 850
600	2 500	2 660	2 510	1 340	1 830	1 830
800	2 490	2 620	2 500	1 365	1 790	1 790
1 000	2 480	2 600	2 490	1 380	1 760	1 760
1 200	2 480	2 580	2 490	1 200	1 730	1 730
1 500	2 480	2 550	2 480	1 415	1 700	1 700
2 000	2 480	2 500	2 480	1 440	1 660	1 660
3 000	2 470	2 470	2 470	1 500	1 600	1 600
>5 000	2 460	2 450	2 460	1 600	1 600	1 600

REMARKS:

1. H AND B IS THE REQUIRED HORIZONTAL CLEARANCE ON THE HIGH LEG OF THE CURVE BASED ON MINIMUM CANT.
2. L AND C IS THE REQUIRED HORIZONTAL CLEARANCE ON THE LOW LEG OF THE CURVE BASED ON MAXIMUM CANT.
3. INTERMEDIATE VALUES MAY BE INTERPOLATED BY THE ENGINEER IN CHARGE.
4. FOR WORKSHOP AREAS AND TEMPORARY WORK, CLEARANCES H AND L MAY BE REDUCED BY 300mm.
5. SEE ANNEXURE 1 SHEET 3 FOR PLATFORM CLEARANCES.
6. ALSO REFER TO REMARKS 4 TO 8 OF ANNEXURE 1 SHEET 2.
7. USE SMALLER RADIUS IF RADIUS IN BETWEEN

VERTICAL CLEARANCES :  
1 065mm TRACK GAUGE

ANNEXURE 1  
SHEET 2 of 5

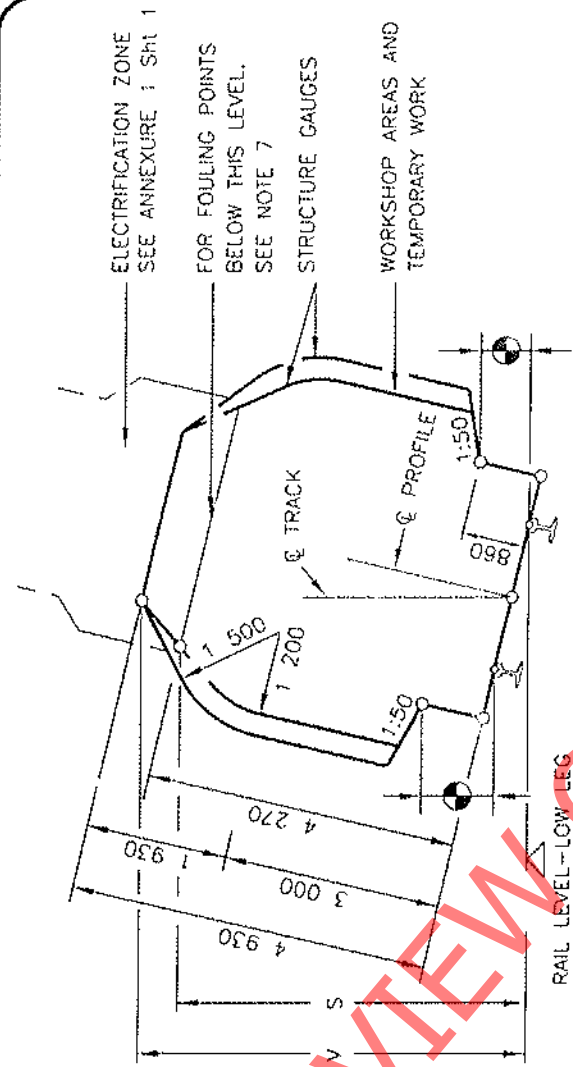

LOCATION	NOT ELECTRIFIED	ELECTRIFIED (PRESENT OR FUTURE)	
		3 kV & 2.5 kV	50 kV
RADIUS (mm)	S (mm)	V (mm)	V (mm)
100	4 470	5 050	5 400
300	4 410	5 020	5 370
600	4 370	5 000	5 350
1 000	4 350	4 990	5 340
1 500	4 310	4 960	5 310
2 000	4 290	4 940	5 290
> 3 000	4 270	4 930	5 280

ALL AREAS OTHER THAN THOSE INDICATED BY \* BELOW

\* OVER OR NEAR POINTS AND CROSSING IF REQUIRED BY ELECTRICAL IRRESPECTIVE OF RADIUS

REMARKS:

1. V IS THE REQUIRED VERTICAL CLEARANCE EXCEPT WHERE REDUCED CLEARANCE S APPLIES.
2. S IS THE MINIMUM VERTICAL CLEARANCE FOR STRUCTURES AND TEMPORARY WORK OVER NON-ELECTRIFIED LINES.
3. INTERMEDIATE VALUES MAY BE INTERPOLATED BY THE ENGINEER IN CHARGE.
4. FOR APPLICATION AT CURVES
  - 4.1 APPLY INCREASED CLEARANCES FOR CURVES TO POINTS 3m BEYOND THE ENDS OF THE CIRCULAR CURVE.
  - 4.2 REDUCE CLEARANCES AT A UNIFORM RATE OVER THE REMAINDER OF THE TRANSITION CURVE.
  - 4.3 FOR NON-TRANSITIONED CURVES REDUCE AT A UNIFORM RATE OVER A LENGTH OF 15m ALONG STRAIGHTS.
5. NEW STRUCTURES: SEE BRIDGE CODE.
6. TUNNELS: SEE DRAWING BE 82-35.
7. FOULING POINTS: SEE CLAUSE 8.1.
8. CLEARANCES ARE BASED ON 15m BOGIE CENTRES AND 21.2m VEHICLE BODY LENGTH.
9. SEE ANNEXURE 1 SHEET 3 FOR PLATFORM CLEARANCES.

# CLEARANCES : PLATFORMS

ANNEXURE 1  
SHEET 3 of 5

## PLATFORMS : TRACK GAUGE 1 065mm

### PASSENGERS

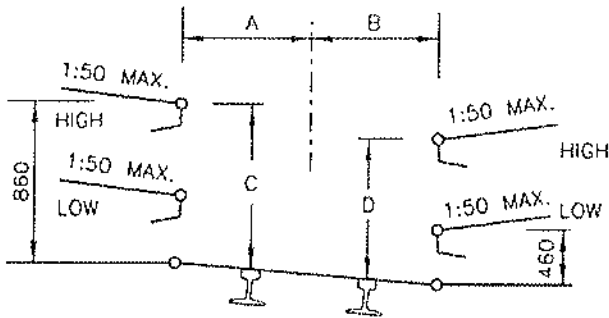

### GOODS

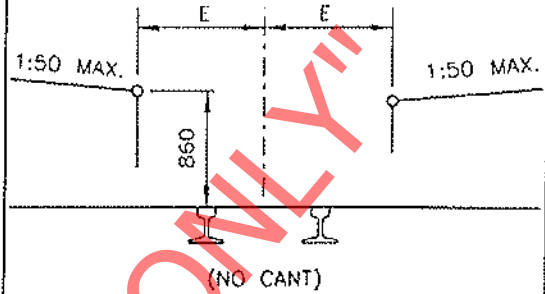

RADIUS (m)	A (mm)	B (mm)	C (mm)	D (mm)	E (mm)
90	1 690	1 820	890	810	840
100	1 650	1 790	890	810	810
120	1 610	1 740	890	810	1 760
140	1 580	1 700	890	810	1 720
170	1 550	1 660	890	810	1 690
200	1 530	1 630	890	820	1 670
250	1 520	1 600	890	820	1 640
300	1 520	1 580	890	830	1 620
350	1 520	1 560	880	830	1 600
400	1 520	1 550	880	840	1 590
500	1 520	1 540	880	850	1 580
600	1 520	1 530	870	850	1 570
800	1 520	1 520	860	860	1 560
1 200	1 520	1 520	860	860	1 550
2 000	1 520	1 520	860	860	1 540
3 000	1 520	1 520	860	860	1 530
STRAIGHT	1 520	1 520	860	860	1 520

#### REMARKS:

1. NO CANT TO BE APPLIED EXCEPT WHEN THE GOODS PLATFORM IS ON A RUNNING LINE.
2. INTERMEDIATE VALUES MAY BE INTERPOLATED BY THE ENGINEER IN CHARGE.
3.  $\odot$  8m TO MAIN STATION-BUILDINGS AND 3m TO ALL OTHER STRUCTURES.
4. TOLERANCES : SEE CLAUSE 8.0.10.
5. ALWAYS USE THE SMALLEST RADIUS

## STRUCTURES ON PLATFORMS : 1 065mm AND 610mm TRACK GAUGE

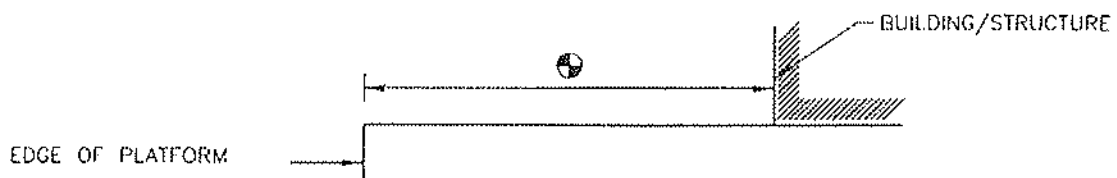

CLEARANCES : 610mm TRACK GAUGE

ANNEXURE 1  
SHEET 5 of 5

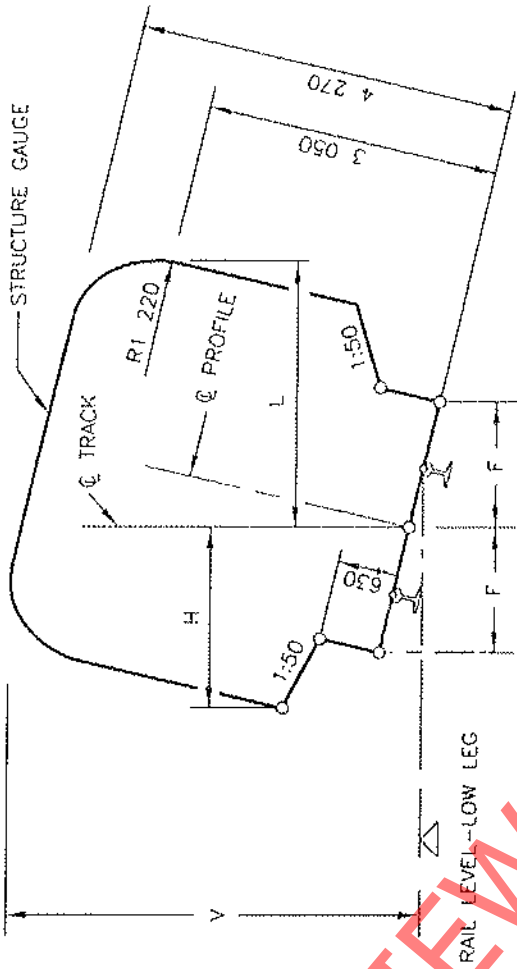

RADIUS (m)	F (mm)
50	1 550
60	1 510
80	1 460
100	1 430
120	1 410
140	1 390
170	1 380
200	1 370
250	1 360
300	1 350
600	1 330
1 000	1 320
>2 000	1 320
STRAIGHT	1 310

RADIUS (m)	WITH CANT		NO CANT		V (mm)
	H (mm)	L (mm)	H & L (mm)		
50	2 370	2 490	2 400	4 320	4 320
70	2 310	2 420	2 330	4 310	4 310
100	2 260	2 370	2 280	4 310	4 310
140	2 220	2 340	2 250	4 310	4 310
200	2 200	2 300	2 220	4 300	4 300
300	2 190	2 270	2 200	4 300	4 300
500	2 180	2 230	2 190	4 290	4 290
700	2 170	2 200	2 180	4 270	4 270
1 000	2 170	2 170	2 170	4 270	4 270
>2 000	2 160	2 160	2 160	4 270	4 270

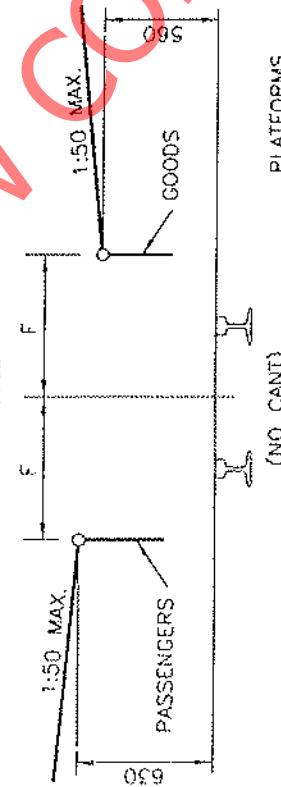

REMARKS:

- H IS THE MINIMUM HORIZONTAL CLEARANCE ON THE OUTSIDE OF THE CURVE BASED ON MINIMUM CANT.
- L IS THE MINIMUM HORIZONTAL CLEARANCE ON THE INSIDE OF THE CURVE BASED ON MAXIMUM CANT.
- V IS THE MINIMUM VERTICAL CLEARANCE.
- FOR APPLICATION AT CURVES:
  - APPLY INCREASED CLEARANCES FOR CURVES TO POINTS 2m BEYOND THE ENDS OF THE CIRCULAR CURVE.
  - REDUCE CLEARANCES AT A UNIFORM RATE OVER THE REMAINDER OF THE TRANSITION CURVE.
  - FOR NON-TRANSITIONED CURVES REDUCE AT A UNIFORM RATE OVER A LENGTH OF 18m ALONG STRAIGHTS.
- INTERMEDIATE VALUES MAY BE INTERPOLATED BY THE ENGINEER IN CHARGE.
- ALSO REFER TO REMARKS 5, 6 AND 7 OF ANNEXURE 1 SHEET 2.
- CLEARANCES ARE BASED ON 9 700mm BOGIE CENTRES AND 13 700mm VEHICLE BODY LENGTH.
- SEE ANNEXURE 1 SHEET 3 FOR STRUCTURES ON PLATFORMS.