

TRANSNET

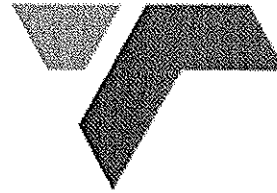

Transnet SOC Limited Registration Number 1990/00900/06

TRANSNET SPECIFICATION

**E7/1 - SPECIFICATION FOR GENERAL WORK AND
WORKS ON, OVER, UNDER OR ADJACENT TO RAILWAY
LINES AND NEAR HIGH VOLTAGE EQUIPMENT**

(This specification shall be used in network operator contracts)







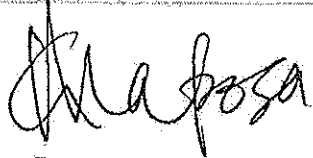

“PREVIEW COPY ONLY”

Circulation Not Restricted

© This document as a whole is protected by copyright. The information herein is the sole property of Transnet SOC Ltd. It may not be used, disclosed or reproduced in part or in whole in any manner whatsoever, except with the written permission of and in a manner permitted by the proprietors.

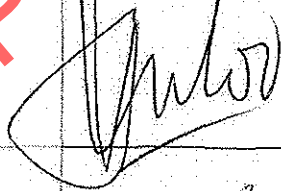
(This page not to be issued with contract)

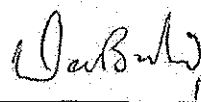
**SPECIFICATION FOR GENERAL WORK AND WORKS ON, OVER, UNDER OR
ADJACENT TO RAILWAY LINES AND NEAR HIGH VOLTAGE EQUIPMENT**

Author:	Project Manager Capital Program (Electrical)	G. Maposa	
Approved:	Senior Engineer Infra Engineering (Train Authorisation Systems)	J. van den Berg	
"	Principal Engineer Infra Engineering (Track)	M. Marutla	
"	Principal Engineer Infra Engineering (Structures)	J. Homan	
"	Principal Engineer Infra Engineering (Electrical)	J. Vosloo	
"	Principal Engineer Technology Management (Electrical)	W. Coetzee	
"	Chief Engineer Transport Telecoms	D. Botha	 17 June 11
Authorised:	Chief Engineer Infrastructure Engineering	J. van Aardt	 2011/06/30

Date: May 2011

(This page not to be issued with contract)

CONTENTS

<u>CLAUSE</u>	<u>HEADING</u>	<u>PAGE</u>
1.0	SCOPE	3
2.0	DEFINITIONS	3
PART A - GENERAL SPECIFICATION		
3.0	AUTHORITY OF OFFICERS OF TRANSNET	4
4.0	CONTRACTOR'S REPRESENTATIVES AND STAFF	4
5.0	OCCUPATIONS AND WORK PERMITS	4
6.0	SPEED RESTRICTIONS AND PROTECTION	5
7.0	ROADS ON THE NETWORK OPERATOR'S PROPERTY	5
8.0	CLEARANCES	5
9.0	STACKING OF MATERIAL	5
10.0	EXCAVATION, SHORING, DEWATERING AND DRAINAGE	5
11.0	FALSEWORK FOR STRUCTURES	6
12.0	PILING	6
13.0	UNDERGROUND SERVICES	6
14.0	BLASTING AND USE OF EXPLOSIVES	6
15.0	RAIL TROLLEYS	7
16.0	SIGNAL TRACK CIRCUITS	7
17.0	PENALTY FOR DELAYS TO TRAINS	7
18.0	SURVEY BEACONS AND PEGS	7
19.0	TEMPORARY LEVEL CROSSINGS	8
20.0	COMPLETION OF THE WORKS	8
21.0	PROTECTION OF PERSONS AND PROPERTY	9
22.0	INTERFERENCE WITH THE NETWORK OPERATOR'S ASSETS AND WORK ON OPEN LINES	10
23.0	ACCESS, RIGHTS-OF-WAY AND CAMPSITES	10
24.0	SUPERVISION	10
25.0	HOUSING OF EMPLOYEES	10
26.0	OPTICAL FIBRE CABLE ROUTES	10
PART B - ADDITIONAL SPECIFICATION FOR WORK NEAR HIGH-VOLTAGE ELECTRICAL EQUIPMENT		
27.0	GENERAL	11
28.0	WORK ON BUILDINGS OR FIXED STRUCTURES	11
29.0	WORK DONE ON OR OUTSIDE OF ROLLING STOCK, INCLUDING LOADING AND UNLOADING	11
30.0	USE OF EQUIPMENT	12
31.0	CARRYING AND HANDLING MATERIAL AND EQUIPMENT	12
32.0	PRECAUTIONS TO BE TAKEN WHEN ERECTING OR REMOVING POLES, ANTENNAE AND TREES ETC.	12
33.0	USE OF WATER	13
34.0	USE OF CONSTRUCTION PLANT	13
35.0	WORK PERFORMED UNDER DEAD CONDITIONS UNDER COVER OF A WORK PERMIT	13
36.0	TRACTION RETURN CIRCUITS IN RAILS	13
37.0	HIGH-VOLTAGE ELECTRICAL EQUIPMENT NOT MAINTAINED AND/OR OPERATED BY THE NETWORK OPERATOR	14

1.0 SCOPE

- 1.1 This specification covers the network operator's requirements for general work and works on, over, under or adjacent to railway lines and near high voltage equipment.

2.0 DEFINITIONS

The following definitions shall apply:

"Authorised Person" - A person whether an employee of the network operator or not, who has been specially authorised to undertake specific duties in terms of 'Transnet' publication Electrical Safety Instructions, and who holds a certificate or letter of authority to that effect.

"Barrier" Any device designed to restrict access to "live" high-voltage electrical equipment.

"Bond" - A short conductor installed to provide electrical continuity.

"Contractor" - Any person or organisation appointed by the network operator to carry out work on its behalf.

"Contract Supervisor" - The person or juristic person appointed by the network operator from time to time as the Contract Supervisor, to administer the Contractor's performance and execution of the Works according to the powers and rights held by and obligations placed upon the Contract Supervisor in terms of the Contract.

"Dead" - Isolated and earthed.

"Electrical Officer (Contracts)" - The person appointed in writing by the Project Manager in terms of this specification as the person who shall be consulted by the Contractor in all electrical matters to ensure that adequate safety precautions are taken by the Contractor.

"Executive Officer" - The person appointed by the network operator from time to time as the Executive Officer to act according to the rights and powers held by and obligations placed upon him in terms of the Contract.

"High-Voltage" - A voltage normally exceeding 1000 volts.

"Live" - A conductor is said to be "live" when it is at a potential different from that of the earth or any other conductor of the system of which it forms a part.

"Near" - To be in such a position that a person's body or the tools he is using or any equipment he is handling may come within 3 metres of "live" exposed high-voltage electrical equipment.

"Occupation" - An authorisation granted by the network operator for work to be carried out under specified conditions on, over, under or adjacent to railway lines.

"Occupation Between Trains" - An occupation during an interval between successive trains.

"Optical Fibre Cable" - Buried or suspended composite cable containing optical fibres used in:

- telecommunication networks for transmission of digital information and
- safety sensitive train operations systems.

"Project Manager" - As defined in the special conditions of the contract. The person or juristic person appointed by the network operator from time to time as the Project Manager, to administer the Contract according to the powers and rights held by and obligations placed upon him in terms of the Contract.

"Responsible Representative" - The responsible person in charge, appointed by a contractor, who has undergone specific training (and holds a certificate) to supervise (general or direct) staff under his control who perform general work or to work on, over, under or adjacent to railway lines and in the vicinity of high-voltage electrical equipment.

"Total Occupation" - An occupation for a period when trains are not to traverse the section of line covered by the occupation.

"Work on" - Work undertaken on or so close to the equipment that the specified working clearances to the "live" equipment cannot be maintained.

"Work Permit" - A combined written application and authority to proceed with work on or near dead electrical equipment.

"Works" - The contractual intent for the work to be done as defined in the contract at a defined work site.

PART A - GENERAL SPECIFICATION**3.0 AUTHORITY OF OFFICERS OF TRANSNET**

- 3.1 The Contractor shall co-operate with the officers of the network operator and shall comply with all instructions issued and restrictions imposed with respect to the Works which bear on the existence and operation of the network operator's railway lines and high-voltage equipment.
- 3.2 Without limiting the generality of the provisions of clause 3.1, any duly authorised representative of the network operator, having identified himself, may stop the work if, in his opinion, the safe passage of trains or the safety of the network operator's assets or any person is affected. **CONSIDERATIONS OF SAFETY SHALL TAKE PRECEDENCE OVER ALL OTHER CONSIDERATIONS.**

4.0 CONTRACTOR'S REPRESENTATIVES AND STAFF

- 4.1 The Contractor shall nominate Responsible Representatives of whom at least one shall be available at any hour for call-out in cases of emergency. The Contractor shall provide the Contract Supervisor with the names, addresses and telephone numbers of the representatives.
- 4.2 The Contractor guarantees that he has satisfied himself that the Responsible Representative is fully conversant with this specification and that he shall comply with all his obligations in respect thereof.
- 4.3 The Contractor shall ensure that all contractor staff receives relevant awareness, educational and competence training regarding safety as prescribed.

5.0 OCCUPATIONS AND WORK PERMITS

- 5.1 Work to be done during total occupation or during an occupation between trains or under a work permit shall be done in a manner decided by the Contract Supervisor and at times to suit the network operator requirements.
- 5.2 The Contractor shall organise the Works in a manner which will minimise the number and duration of occupations and work permits required.
- 5.3 The network operator will not be liable for any financial or other loss suffered by the Contractor arising from his failure to complete any work scheduled during the period of an occupation or work permit.
- 5.4 The Contractor shall submit to the Contract Supervisor, in writing, requests for occupations or work permits together with details of the work to be undertaken, at least 21 days before they are required. The network operator does not undertake to grant an occupation or work permit for any particular date, time or duration.
- 5.5 The network operator reserves the right to cancel any occupation or work permit at any time before or during the period of occupation or work permit. If, due to cancellation or change in date or time, the Contractor is not permitted to start work under conditions of total occupation or work permit at the time arranged, all costs caused by the cancellation shall be born by the Contractor except as provided for in clauses 5.6 to 5.8.
- 5.6 When the Contractor is notified less than 2 hours before the scheduled starting time that the occupation or work permit is cancelled, he may claim reimbursement of his direct financial losses caused by the loss of working time up to the time his labour and plant are employed on other work, but not exceeding the period of the cancelled occupation or work permit.
- 5.7 When the Contractor is notified less than 2 hours before the scheduled starting time, or during an occupation or work permit, that the duration of the occupation or work permit is reduced, he may claim reimbursement of his direct financial losses caused by the loss of working time due to the reduced duration of the occupation or work permit.
- 5.8 Reimbursement of the Contractor for any loss of working time in terms of clause 5.6 and 5.7, shall be subject to his claims being submitted within 14 days of the event with full details of labour and plant involved, and provided that the Contract Supervisor certifies that no other work on which the labour and plant could be employed was immediately available.
- 5.9 Before starting any work for which an occupation has been arranged, the Contractor shall obtain from the Contract Supervisor written confirmation of the date, time and duration of the occupation.
- 5.10 Before starting any work for which a work permit has been arranged, the Responsible Representative shall read and sign portion C of the Work Permit, signifying that he is aware of the work boundaries within which work may be undertaken. After the work for which the permit was granted has been completed, or when the

work permit is due to be terminated, or if the permit is cancelled after the start, the same person who signed portion C shall sign portion D of the Work Permit, thereby acknowledging that he is aware that the electrical equipment is to be made "live". The Contractor shall advise all his workmen accordingly.

6.0 SPEED RESTRICTIONS AND PROTECTION

6.1 When speed restrictions are imposed by the network operator because of the Contractor's activities, the Contractor shall organise and carry out his work so as to permit the removal of the restrictions as soon as possible.

6.2 When the Contract Supervisor considers protection to be necessary the Contractor shall, unless otherwise agreed, provide all protection including flagmen, other personnel and all equipment for the protection of the network operator's and the Contractor's personnel and assets, the public and including trains.

6.2.1 The network operator will provide training free of charge of the Contractor's flagmen and other personnel performing protection duties. The Contractor shall consult with the Contract Supervisor, whenever he considers that protection will be necessary, taking into account the minimum permissible clearances set out in the Manual for Track Maintenance (Document no. BBB0481):

- Drawing no. BE-97 Sheet 1: Horizontal Clearances: 1065mm gauge (Annexure 1 sheet 1)
- Drawing no. BE-97 Sheet 2: Vertical Clearances: 1065mm gauge (Annexure 1 sheet 2)
- Drawing no. BE-97 Sheet 3: Clearances: Platform (Annexure 1 sheet 3)
- Drawing no. BE-97 Sheet 5: Clearances: 610mm Gauge (Annexure 1 sheet 5)

6.3 The Contractor shall appoint a Responsible Representative to receive and transmit any instruction which may be given by the network operator personnel providing protection.

7.0 ROADS AND ROADS ON THE NETWORK OPERATOR'S PROPERTY

7.1 The Contractor shall take every reasonable precaution to prevent damage to any roads or bridges used to obtain access to the site, and shall select routes, use vehicles, and restrict loads so that any extraordinary traffic as may arise from the moving of plant or material to or from the site shall be limited as far as is reasonably possible.

7.2 The Contractor shall not occupy or interfere in any way with the free use of any public or private road, right-of-way, path or street unless the Contract Supervisor has obtained the approval of the road authority concerned.

8.0 CLEARANCES

8.1 No temporary works shall encroach on the appropriate minimum clearances set out in the Manual for Track Maintenance (Document no. BBB0481):

- Drawing no. BE-97 Sheet 1: Horizontal Clearances: 1065mm gauge (Annexure 1 sheet 1)
- Drawing no. BE-97 Sheet 2: Vertical Clearances: 1065mm gauge (Annexure 1 sheet 2)
- Drawing no. BE-97 Sheet 3: Clearances: Platform (Annexure 1 sheet 3)
- Drawing no. BE-97 Sheet 5: Clearances: 610mm Gauge (Annexure 1 sheet 5)

9.0 STACKING OF MATERIAL

9.1 The Contractor shall not stack any material closer than 3m from the centre line of any railway line without prior approval of the Contract Supervisor.

10.0 EXCAVATION, SHORING, DEWATERING AND DRAINAGE

10.1 Unless otherwise approved by the Contract Supervisor any excavation adjacent to a railway line shall not encroach on the hatched area shown in Figure 1.

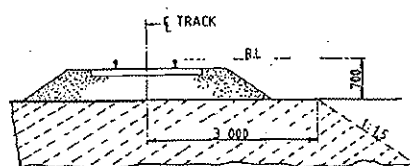

- 10.2 The Contractor shall provide, at his own cost any shoring, dewatering or drainage of any excavation unless otherwise stipulated elsewhere in the Contract.
- 10.3 Where required by the Contract Supervisor, drawings of shoring for any excavation under or adjacent to a railway line shall be submitted and permission to proceed, obtained before the excavation is commenced.
- 10.4 The Contractor shall prevent ingress of water to the excavation but where water does enter, he shall dispose of it as directed by the Contract Supervisor.
- 10.5 The Contractor shall not block, obstruct or damage any existing drains either above or below ground level unless he has made adequate prior arrangements to deal with drainage.

11.0 FALSEWORK FOR STRUCTURES

- 11.1 Drawings of falsework for the construction of any structure over, under or adjacent to any railway line shall be submitted to the Contract Supervisor and his permission to proceed obtained before the falsework is erected. Each drawing shall be given a title and a distinguishing number and shall be signed by a registered professional engineer certifying that he has checked the design of the falsework and that the drawings are correct and in accordance with the design.
- 11.2 After the falsework has been erected and before any load is applied, the Contractor shall submit to the Contract Supervisor a certificate signed by a registered professional engineer certifying that he has checked the falsework and that it has been erected in accordance with the drawings. Titles and numbers of the drawings shall be stated in the certificate. Notwithstanding permission given by the Contract Supervisor to proceed, the Contractor shall be entirely responsible for the safety and adequacy of the falsework.

12.0 PILING

- 12.1 The Contract Supervisor will specify the conditions under which piles may be installed on the network operator's property.

13.0 UNDERGROUND SERVICES

- 13.1 No pegs or stakes shall be driven or any excavation made before the Contractor has established that there are no underground services which may be damaged thereby.
- 13.2 Any damage shall be reported immediately to the Contract Supervisor, or to the official in charge at the nearest station, or to the traffic controller in the case of centralised traffic control.

14.0 BLASTING AND USE OF EXPLOSIVES

- 14.1 When blasting within 500m of a railway line, the Contractor shall observe the requirements stipulated in this specification.
- 14.2 No blasting shall be carried out except with the prior written permission of the Contract Supervisor and under such conditions as he may impose.
- 14.3 On electrified lines the Contractor shall also obtain the permission of the Electrical Officer (Contracts) before blasting, and shall give at least 21 days notice of his intention to blast. No blasting shall be done in the vicinity of electrified lines unless a member of the network operator's electrical personnel is present.
- 14.4 The Contractor shall arrange for the supply, transport storage and use of explosives.
- 14.5 The Contractor shall have labour, tools and plant, to the satisfaction of the Contract Supervisor, available on the site to clear immediately any stones or debris deposited on the track or formation by blasting, and to repair any damage to the track or formation immediately after blasting. Repairs to the track shall be carried out only under the supervision of a duly authorised representative of the network operator.
- 14.6 The Contractor shall notify the Contract Supervisor of his intention to blast at least 21 days before the commencement of any blasting operations.
- 14.7 Before any blasting is undertaken, the Contractor and the Contract Supervisor shall jointly examine and measure up any buildings, houses or structures in the vicinity of the proposed blasting to establish the extent of any existing cracking or damage to such structures, etc. The Contractor, shall, subject to the provisions stipulated in the Contract Insurance Policy, make good any deterioration of such buildings, houses, or structures, which, in the opinion of the Contract Supervisor, was directly caused by the blasting.
- 14.8 After completion of the blasting the Contractor shall obtain a written clearance from each landowner in

the vicinity of the blasting operations to the effect that all claims for compensation in respect of damage caused by the blasting operations to their respective properties, have been settled.

14.9 The Contractor shall provide proof that he has complied with the provisions of clauses 10.17.1 to 10.17.4 of the Explosives Regulations (Act 26 of 1956 as amended).

14.10 Blasting within 500m of a railway line will only be permitted during intervals between trains. A person appointed by the Contract Supervisor, assisted by flagmen with the necessary protective equipment, will be in communication with the controlling railway station.

Only this person will be authorised to give the Contractor permission to blast, and the Contractor shall obey his instructions implicitly regarding the time during which blasting may take place.

14.11 The flagmen described in clause 14.10, where provided by the network operator, are for the protection of trains and the network operator's property only, and their presence does not relieve the Contractor in any manner of his responsibilities in terms of Explosives Act or Regulations, or any obligation in terms of this Contract.

14.12 The person described in clause 14.10 will record in a book provided and retained by the network operator, the dates and times:-

(i) when each request is made by him to the controlling station for permission to blast;

(ii) when blasting may take place;

(iii) when blasting actually takes place; and

(iv) when he advises the controlling station that the line is safe for the passage of trains.

14.13 Before each blast the Contractor shall record in the same book, the details of the blast to be carried out. The person appointed by the Contract Supervisor and the person who will do the blasting shall both sign the book whenever an entry described in clause 14.12 is made.

15.0 RAIL TROLLEYS

15.1 The use of rail trolleys or trestle trolleys on a railway line for working on high voltage equipment will be permitted only if approved by the Contract Supervisor and under the conditions stipulated by him.

15.2 All costs in connection with trolley working and any train protection services requested by the Contractor shall, be borne by the Contractor, unless otherwise agreed.

16.0 SIGNAL TRACK CIRCUITS

16.1 Where signal track circuits are installed, the Contractor shall ensure that no material capable of conducting an electrical current makes contact between rails of railway line/lines.

16.2 No signal connections on track-circuited tracks shall be severed without the Contract Supervisor's knowledge and consent.

17.0 PENALTY FOR DELAYS TO TRAINS

17.1 If any trains are delayed by the Contractor and the Contract Supervisor is satisfied that the delay was avoidable, a penalty will be imposed on the Contractor as stipulated in the contract, for the period and number of trains delayed.

18.0 SURVEY BEACONS AND PEGS

18.1 The Contractor shall not on any account move or damage any beacon, bench mark, reference mark, signal or trigonometrical station in the execution of the Works without the written approval of the Contract Supervisor.

Should the Contractor be responsible for any such occurrence, he shall report the circumstances to the Contract Supervisor who will arrange with the Director-General of Surveys for replacement of the beacon or mark at the cost of the Contractor.

18.2 The Contractor shall not move or damage any cadastral or mining beacon without the written approval of the Contract Supervisor and before it has been referenced by a registered land surveyor. Any old boundary beacon, which becomes an internal beacon on creation of new boundaries, shall not be moved without the written approval of the Contract Supervisor.

Should the Contractor move or damage any cadastral or mining beacon without authority, he shall be responsible for having it replaced, at his cost, by a land surveyor.

- 18.3 The Contractor shall preserve all pegs and bench marks. Such survey points shall not be removed without the written approval of the Contract Supervisor. Should any peg or benchmark be removed without authority, the Contract Supervisor will arrange for its replacement and the cost will be recovered from the Contractor. No claim will be considered for delay in replacing any such peg or bench mark. Each peg replaced shall be checked by the Contractor.
- 18.4 Where a new boundary has been established, beacons on the fence line shall not be disturbed, and fence posts or anchors may not be placed or excavations made within 0,6 m of any beacon without the prior written approval of the Contract Supervisor.

19.0 TEMPORARY LEVEL CROSSINGS

- 19.1 The Contract Supervisor may, on request of the Contractor, and if necessary for the purpose of execution of the Works, permit the construction of a temporary level crossing over a railway a line at a position approved by the Contract Supervisor and at the Contractor's cost. The period for which the temporary level crossing is permitted will be at the discretion of the Contract Supervisor.
- 19.2 The Contractor will provide protection and supervise the construction of the road over the track(s) and within the railway servitude at the level crossing, as well as the erection of all road signs and height gauges. All cost to be borne by the applicant.

The Contractor shall exercise extreme caution in carrying out this work, especially in respect of damage to tracks, services, overhead power and communications routes and prevent contact with "live" overhead electrical equipment.

Unless otherwise agreed, the Contractor will provide the service deviations or alterations to the network operator's track-, structure-, drainage-, electrical-, telecommunications- and train authorisation systems to accommodate the level crossing.

- 19.3 The Contractor shall take all necessary steps including the provision of gates, locks and, where necessary, watchmen to restrict the use of the temporary level crossing to himself and his employees, his subcontractors and their employees, the staff of the network operator and to such other persons as the Contract Supervisor may permit and of whose identity the Contractor will be advised. If so ordered by the Contract Supervisor, the Contractor shall provide persons to control road traffic using the temporary level crossing. Such persons shall stop all road traffic when any approaching train is within seven hundred and fifty (750) metres of the temporary level crossing, and shall not allow road traffic to proceed over it until the lines are clear.
- 19.4 The Contractor shall maintain the temporary level crossing within the railway servitude in good condition for the period it is in use. A temporary agreement with the road authority to be concluded for the maintenance of the level crossing outside the railway servitude.
- 19.5 When the temporary level crossing is no longer required by the Contractor, or permitted by the network operator, the Contractor shall at his own cost remove it and restore the site and the network operator's track-, structure-, drainage-, electrical-, telecommunications- and train authorisation systems to its original condition. Work over the tracks and within the railway servitude will be supervised by the network operator.

20.0 COMPLETION OF THE WORKS

- 20.1 On completion of the works, the Contractor shall remove all the remaining construction plant and material from the site, other than material which is the property of the network operator, and leave the site in a clean, neat and tidy condition. If material and plant is required for the liability and maintenance period the Contract supervisor must authorise it's retention on site.

21.0 PROTECTION OF PERSONS AND PROPERTY

- 21.1 The Contractor shall provide and maintain all lights, guards, barriers, fencing and watchmen when and where necessary or as required by the Contract Supervisor or by any statutory authority, for the protection of the Works and for the safety and convenience of the public.

Red, yellow, green or blue lights may not be used by the Contractor as they can be mistaken for signals. Red, yellow, green or white flags shall only be used for protection by the Contractor. Within the precincts of a port the Contractor shall obtain the permission of the Port Captain before installing any light.

- 21.2 The Contractor shall take all the requisite measures and precautions during the course of the Works to:
- (i) protect the public and property of the public,
 - (ii) protect the property and workmen of both the network operator and the Contractor,
 - (iii) avoid damage to and prevent trespass on adjoining properties, and
 - (iv) ensure compliance with any instruction issued by the Contract Supervisor or other authorised person, and with any stipulation embodied in the contract documents which affects the safety of any person or thing.
- 21.3 The network operator will provide, at its own cost, protection for the safe working of trains during such operations as the Contract Supervisor may consider necessary. Protection by the network operator for any purpose whatsoever, does not absolve the Contractor of his responsibilities in terms of the Contract.
- 21.4 The Contractor shall take all precautions and appoint guards, watchmen and compound managers for prevention of disorder among and misconduct by the persons employed on the Works and by any other persons, whether employees or not, on the work site and for the preservation of the peace and protection of persons and property in the direct neighbourhood. Any relocation of camps because of disorder shall be at the Contractor's expense.
- 21.5 All operations necessary for the execution of the Works, including the provision of any temporary work and camping sites, shall be carried out so as not to cause veldt fires, ground and environmental pollution, soil erosion or restriction of or interference with streams, furrows, drains and water supplies.
- If the original surface of the ground is disturbed in connection with the Works, it shall be made good by the Contractor to the satisfaction of the land owner, occupier or responsible authority.
- 21.6 The Contractor shall take all reasonable steps to minimise noise and disturbance when carrying out the Works, including work permitted outside normal working hours.
- 21.7 Dumping of waste or excess materials by the Contractor shall, in urban areas, be done under the direction and control of, and at sites made available by the local authority. Dumping outside local authority boundaries shall be done only with the express permission and under the direction and control of the Contract Supervisor.
- 21.8 The Contractor shall comply with environmental protection measures and specifications stipulated by the Contract Supervisor and/or local and environmental authorities.
- 22.0 INTERFERENCE WITH THE NETWORK OPERATOR'S ASSETS AND WORK ON OPEN LINES**
- 22.1 The Contractor shall not interfere in any manner whatsoever with an open line, nor shall he carry out any work or perform any act which affects the security, use or safety of an open line except with the authority of the Contract Supervisor and in the presence of a duly authorised representative of the network operator.
- 22.2 The Contractor shall not carry out any work or operate any plant, or place any material whatsoever nearer than three metres from the centre line of any open line except with the written permission of the Contract Supervisor and subject to such conditions as he may impose.
- 22.3 Care must be taken not to interfere with or damage any services such as overhead wire routes, cables or pipes and optical fibre cable, except as provided for the work specified. The Contractor will be held responsible for any damage to or interruption of such services arising from any act or omission on his part or of any of his employees, or persons engaged by him on the Works. The cost of repairing, replacing or restoring the services, as well as all other costs arising from any damage to services, shall be borne by, and will be recovered from the Contractor.
- 22.4 Authority granted by the Contract Supervisor and the presence of an authorised representative of the network operator in terms hereof, shall not relieve the Contractor of his duty to comply with this specification.
- 23.0 ACCESS, RIGHTS-OF-WAY AND CAMPSITES**
- 23.1 Where entry onto the network operator's property is restricted, permission to enter will be given only for the purpose of carrying out the Works and will be subject to the terms and conditions laid down by the network operator.
- 23.2 The Contractor shall arrange for campsites, workplaces and access thereto as well as for any right-of-

way over private property to the site of the Works, and for access within the boundaries of the network operator's property. The owners of private property to be traversed shall be approached and treated with tact and courtesy by the Contractor, who shall, if necessary, obtain a letter of introduction to such property owners from the Contract Supervisor.

The Contractor shall be responsible for the closing of all gates on roads and tracks used by him or his employees. Except with the prior approval of the Contract Supervisor and the owner or occupier of any private land to be traversed, the Contractor shall not cut, lower, damage, remove or otherwise interfere with any fence or gate which is either on the network operator's property or on private property and which restricts access to the Works. Where such approval has been given, the Contractor shall prevent entry of animals or unauthorised persons onto the network operator's or private property, and shall make the fences safe against trespass at the close of each day's work.

23.3 The Contractor shall take all reasonable steps to confine the movement of vehicles and plant to the approved right-of-way to minimise damage to property, crops and natural vegetation.

23.4 When access is no longer required, and before completion of the Works, the Contractor shall repair, restore or replace any fence or gate damaged during execution of the Works to the satisfaction of the Contract Supervisor and shall furnish the Contract Supervisor with a certificate signed by the owner and occupier of land over which he has gained access to a campsite, workplace and the Works, certifying that the owner and occupier have no claim against the Contractor or the network operator arising from the Contractor's use of the land. Should the Contractor be unable to obtain the required certificate, he shall report the circumstances to the Contract Supervisor.

24.0 SUPERVISION

24.1 The Contract Supervisor will provide overall technical superintendence of the Works, and may direct the Contractor in terms of the provisions of the Contract or in respect of any measures which the Contract Supervisor may require for the operations of the network operator, the safety of trains, property and workmen of the network operator, and for the safety of other property and persons. The Contractor shall carry out the directions of the Contract Supervisor. The superintendence exercised by the Contract Supervisor, including any agreement, approval, refusal or withdrawal of any approval given, shall not relieve the Contractor of any of his duties and liabilities under the Contract, and shall not imply any assumption by the network operator or by the Contract Supervisor of the legal and other responsibilities of the Contractor in carrying out the Works.

24.2 The Contract Supervisor may delegate to any deputy or other person, any of his duties or functions under the Contract. On receiving notice in writing of such delegation, the Contractor shall recognise and obey the deputy or person to whom any such duties or functions have been delegated as if he were the Contract Supervisor.

24.3 The Contractor shall exercise supervision over the Works at all times when work is performed or shall be represented by an agent having full power and authority to act on behalf of the Contractor. Such agent shall be competent and responsible, and have adequate experience in carrying out work of a similar nature to the Works, and shall exercise personal supervision on behalf of the Contractor. The Contract Supervisor shall be notified in writing of such appointment which will be subject to his approval.

24.4 The Contractor or his duly authorised agent shall be available on the site at all times while the Works are in progress to receive the orders and directions of the Contract Supervisor.

25.0 HOUSING OF EMPLOYEES

25.1 The Contractor shall, where necessary, make his own arrangements for suitable housing of his employees. Where temporary housing is permitted by the Contract Supervisor on any part of the site, the Contractor shall provide suitable sanitation, lighting and potable water supplies in terms of the requirements of the local authority or the current network operator's specification; Minimum Communal Health Requirements in Areas outside the Jurisdiction of a Local Authority - E.4B, as applicable.

25.2 Fouling the area inside or outside the network operator's boundaries shall be prevented. The Contractor will be called upon by the Contract Supervisor to dispose of any foul or waste matter generated by the Contractor.

26.0 OPTICAL FIBRE CABLE ROUTES

26.1 The Contractor shall not handle, impact, move or deviate any optical fibre cable without prior approval.

26.2 Works that in any way affect the optical fibre cable requires prior approval from the Contract Supervisor

who will determine the work method and procedures to be followed.

“PREVIEW COPY ONLY”

PART B - SPECIFICATION FOR WORK NEAR HIGH-VOLTAGE ELECTRICAL EQUIPMENT
27.0 GENERAL

27.1 This specification is based on the contents of Transnet's publication ELECTRICAL SAFETY INSTRUCTIONS, as amended, a copy of which will be made available on loan to the Contractor for the duration of the contract.

These instructions apply to all work near "live" high-voltage equipment maintained and/or operated by the network operator, and the onus rests on the Contractor to ensure that he obtains a copy.

27.2 This specification must be read in conjunction with and not in lieu of the Electrical Safety Instructions.

27.3 The Contractor's attention is drawn in particular to the contents of Part I, Sections 1 and 2 of the Electrical Safety Instructions.

27.4 The Electrical Safety Instructions cover the minimum safety precautions which must be taken to ensure safe working on or near high-voltage electrical equipment, and must be observed at all times. Should additional safety measures be considered necessary because of peculiar local conditions, these may be ordered by and at the discretion of the Electrical Officer (Contracts).

27.5 The Contractor shall obtain the approval of the Electrical Officer (Contracts) before any work is done which causes or could cause any portion of a person's body or the tools he is using or any equipment he is handling, to come within 3 metres of any "live" high-voltage equipment.

27.6 The Contractor shall regard all high-voltage equipment as "live" unless a work permit is in force.

27.7 Safety precautions taken or barriers erected shall comply with the requirements of the Electrical Officer (Contracts), and shall be approved by him before the work to be protected is undertaken by the Contractor. The Contractor shall unless otherwise agreed, bear the cost of the provision of the barriers and other safety precautions required, including the attendance of the network operator's staff where this is necessary.

27.8 No barrier shall be removed unless authorised by the Electrical Officer (Contracts).

28.0 WORK ON BUILDINGS OR FIXED STRUCTURES

28.1 Before any work is carried out or measurements are taken on any part of a building, fixed structure or earthworks of any kind above ground level situated within 3 metres of "live" high-voltage equipment, the Electrical Officer (Contracts) shall be consulted to ascertain the conditions under which the work may be carried out.

28.2 No barrier erected to comply with the requirements of the Electrical Officer (Contracts) shall be used as temporary staging or shuttering for any part of the Works.

28.3 The shuttering for bridge piers, abutments, retaining walls or parapets adjacent to or over any track may be permitted to serve as a barrier, provided that it extends at least 2,5 metres above any working level in the case of piers, abutments and retaining walls and 1,5 metres above any working level in the case of parapets.

29.0 WORK DONE ON OR OUTSIDE OF ROLLING STOCK, INCLUDING LOADING OR UNLOADING

29.1 No person may stand, climb or work, whilst on any platform, surface or foothold:

29.1.1 higher than the normal unrestricted access way, namely -

29.1.1.1 external walkways on diesel, steam and electric locomotives, steam heat vans, etc. and

29.1.1.2 walkways between coaches and locomotives.

29.1.2 of restricted access ways in terms of the Electrical Safety Instructions namely -

29.1.2.1 the floor level of open wagons

29.1.2.2 external walkways or decks of road-rail vehicles, on-track maintenance machines and material trains.

29.1.3 Unauthorised staff working on these platforms must be directly supervised by duly authorised persons in terms of clause 607.1.3 of the Electrical Safety Instructions. These persons must attend the relevant electrical safety module training. A letter of training must then be issued by an accredited training authority. A Category C Certificate of Authority must be obtained from the

local depot examining officer.

- 29.2 When in the above positions no person may raise his hands or any equipment he is handling above his head.
- 29.3 In cases where the Contractor operates his own rail mounted equipment, he shall arrange for the walkways on this plant to be inspected by the Electrical Officer (Contracts) and approved, before commencement of work.
- 29.4 The handling of long lengths of material such as metal pipes, reinforcing bars, etc should be avoided, but if essential they shall be handled as nearly as possible in a horizontal position below head height.
- 29.5 The Responsible Representative shall warn all persons under his control of the danger of being near "live" high-voltage equipment, and shall ensure that the warning is fully understood.
- 29.6 Where the conditions in clauses 30.1 to 30.4 cannot be observed the Electrical Officer (Contracts), shall be notified. He will arrange for suitable Safety measures to be taken. The Electrical Officer (Contracts), may in his discretion and in appropriate circumstances, arrange for a suitable employee of the Contractor to be specially trained by the network operator and at the Contractor's cost, as an Authorised Person to work closer than 3 metres from "live" overhead conductors and under such conditions as may be imposed by the senior responsible electrical engineer of the network operator.

30.0 USE OF EQUIPMENT

30.1 Measuring Tapes and Devices

- 30.1.1 Measuring tapes may be used near "live" high-voltage equipment provided that no part of any tape or a person's body comes within 3 metres of the "live" equipment.
- 30.1.2 In windy conditions the distance shall be increased to ensure that if the tape should fall it will not be blown nearer than 3 metres from the "live" high-voltage equipment.
- 30.1.3 Special measuring devices longer than 2 metres such as survey sticks and rods may be used if these are of non-conducting material and approved by the responsible Electrical Engineer of the network operator, but these devices must not be used within 3 metres of "live" high-voltage equipment in rainy or wet conditions.
- 30.1.4 The assistance of the Electrical Officer (Contracts) shall be requested when measurements within the limits defined in clauses 31.1.1 to 31.1.3 are required.
- 30.1.5 The restrictions described in 31.1.1 to 31.1.3 do not apply on a bridge deck between permanent parapets nor in other situations where a barrier effectively prevents contact with the "live" high-voltage equipment.

30.2 Portable Ladders

- 30.2.1 Any type of portable ladder longer than 2 metres may only be used near "live" high-voltage equipment under the direct supervision of the Responsible Representative. He shall ensure that the ladder is always used in such a manner that the distance from the base of the ladder to any "live" high-voltage equipment is greater than the fully extended length of the ladder plus 3 metres. Where these conditions cannot be observed, the Electrical Officer (Contracts) shall be advised, and he will arrange for suitable safety measures to be taken.

31.0 CARRYING AND HANDLING MATERIAL AND EQUIPMENT

- 31.1 Pipes, scaffolding, iron sheets, reinforcing bars and other material which exceeds 2 metres in length shall be carried completely below head height near "live" high-voltage equipment. For maximum safety such material should be carried by two or more persons so as to maintain it as nearly as possible in a horizontal position. The utmost care must be taken to ensure that no part of the material comes within 3 metres of any "live" high-voltage equipment.
- 31.2 Long lengths of wire or cable shall never be run out in conditions where a part of a wire or cable can come within 3 metres of any "live" high-voltage equipment unless the Electrical Officer (Contracts) has been advised and has approved appropriate safety precautions.
- 31.3 The presence of overhead power lines shall always be taken account of especially when communications lines or cables or aerial cables, stay wires, etc. are being erected above ground level.

32.0 PRECAUTIONS TO BE TAKEN WHEN ERECTING OR REMOVING POLES, ANTENNAE, TREES ETC.

- 32.1 A pole may be handled for the purpose of erection or removal near high-voltage equipment under the following conditions:

(i) If the distance between the point at which the pole is to be erected or removed and the nearest "live" high-voltage equipment is more than the length of the pole plus 3 metres, the work shall be supervised by the Responsible Representative.

(ii) If the distance described in (i) is less than the length of the pole plus 3 metres, the Electrical Officer (Contracts) shall be consulted to arrange for an Authorised Person to supervise the work and to ensure that the pole is earthed where possible. The pole shall be kept in contact with the point of erection, and adequate precautions shall be taken to prevent contact with "live" high-voltage equipment.

32.2 The cost of supervision by an Authorised Person and the provision of earthing shall, unless otherwise agreed, be borne by the Contractor.

32.3 The provisions of clauses 33.1 and 33.2 shall also apply to the erection or removal of columns, antennae, trees, posts, etc.

33.0 USE OF WATER

33.1 No water shall be used in the form of a jet if it can make contact with any "live" high-voltage equipment or with any person working on such equipment.

34.0 USE OF CONSTRUCTION PLANT

34.1 "Construction plant" entails all types of plant including cranes, piling frames, boring machines, excavators, draglines, dewatering equipment and road vehicles with or without lifting equipment.

34.2 When work is being undertaken in such a position that it is possible for construction plant or its load to come within 3 metres of "live" high-voltage equipment, the Electrical Officer (Contracts) shall be consulted. He will arrange for an Authorised Person to supervise the work and to ensure that the plant is adequately earthed. The Electrical Officer (Contracts) will decide whether further safety measures are necessary.

34.3 The cost of any supervision by an Authorised Person and the provision of earthing shall, unless otherwise agreed, be borne by the Contractor.

34.4 When loads are handled by cranes, non-metallic rope hand lines shall be used, affixed to such loads so as to prevent their swinging and coming within 3 metres of "live" high-voltage equipment.

34.5 Clauses 35.1 to 35.4 shall apply *mutatis mutandis* to the use of maintenance machines of any nature.

35.0 WORK PERFORMED UNDER DEAD CONDITIONS UNDER COVER OF A WORK PERMIT

35.1 If the Responsible Representative finds that the work cannot be done in safety with the high-voltage electrical equipment "live", he shall consult the Electrical Officer (Contracts) who will decide on the action to be taken.

35.2 If a work permit is issued the Responsible Representative shall-

(i) before commencement of work ensure that the limits within which work may be carried out have been explained to him by the Authorised Person who issued the permit to him, and that he fully understands these limits.

(ii) sign portion C of the permit before commencement of work;

(iii) explain to all persons under his control the limits within which work may be carried out, and ensure that they fully understand these limits;

(iv) care for the safety of all persons under his control whilst work is in progress; and

(v) withdraw all personnel under his control from the equipment on completion of the work before he signs portion D of the work permit.

36.0 TRACTION RETURN CIRCUITS IN RAILS

36.1 DANGEROUS CONDITIONS CAN BE CREATED BY REMOVING OR SEVERING ANY BOND.

36.2 Broken rails with an air gap between the ends, and joints at which fishplates are removed under "broken bond" conditions, are potentially lethal. The rails on either side of an air gap between rail ends on electrified lines shall not be touched simultaneously until rendered safe by the network operator personnel.

36.3 The Contractor shall not break any permanent bonds between rails or between rails and any structure. He shall give the Contract Supervisor at least 7 days written notice when removal of such bonds is necessary.

36.4 No work on the track which involves interference with the traction return rail circuit either by cutting or removing the rails, or by removal of bonds shall be done unless the Electrical Officer (Contracts) is consulted. He will take such precautions as may be necessary to ensure continuity of the return circuit before permitting the work to be commenced.

37.0 HIGH-VOLTAGE ELECTRICAL EQUIPMENT NOT MAINTAINED AND/OR OPERATED BY THE NETWORK OPERATOR

Where the work is undertaken on or near high-voltage electrical equipment which is not maintained and/or operated by the network operator, the Occupational Health and Safety Act No. 85 of 1993, and Regulations and Instructions, or the Mines Health and Safety Act (Act 29 of 1996), shall apply.

Such equipment includes:-

- (i) Eskom and municipal equipment;
- (ii) The Contractor's own power supplies; and
- (iii) Electrical equipment being installed but not yet taken over from the Contractor.

END

“PREVIEW COPY ONLY”

HORIZONTAL CLEARANCES :
1 065mm TRACK GAUGE

ANNEXURE 1
SHEET 1 of 5

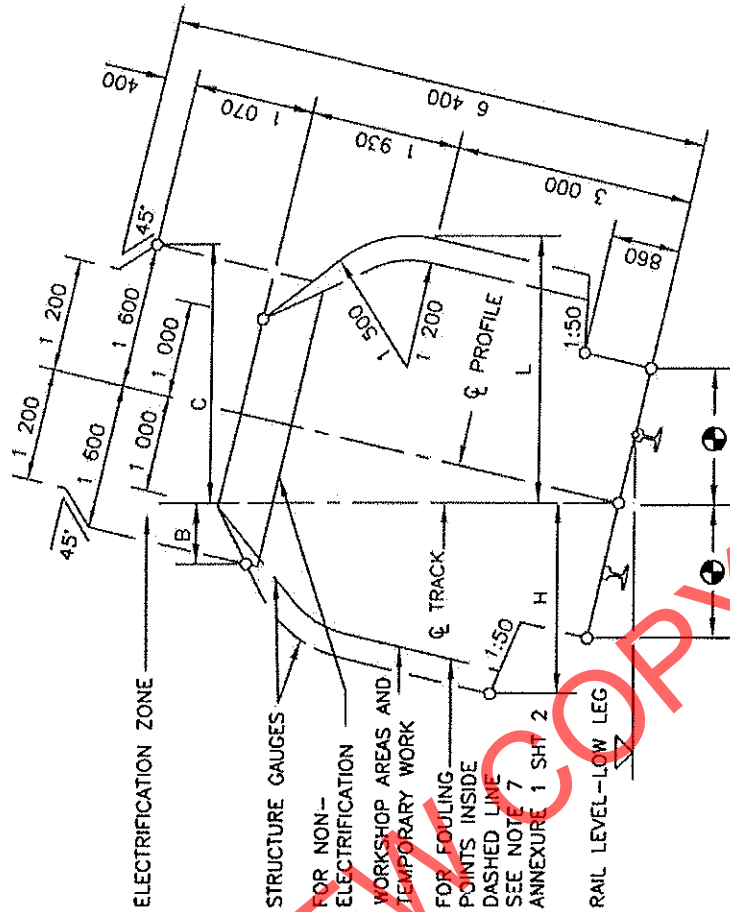

RADIUS (m)	WITH CANT		NO CANT		WITH CANT	
	H (mm)	L (mm)	H & L	B (mm)	C (mm)	C (mm)
90	2 730	3 090	2 780	1 30	2 100	2 100
100	2 700	3 030	2 750	1 140	2 050	2 050
120	2 650	2 970	2 700	1 160	2 010	2 010
140	2 620	2 920	2 660	1 175	1 990	1 990
170	2 590	2 870	2 630	1 190	1 970	1 970
200	2 570	2 820	2 600	1 205	1 950	1 950
250	2 550	2 790	2 580	1 230	1 920	1 920
300	2 540	2 760	2 560	1 250	1 900	1 900
350	2 530	2 730	2 540	1 270	1 890	1 890
400	2 520	2 710	2 530	1 290	1 875	1 875
500	2 510	2 680	2 520	1 320	1 850	1 850
600	2 500	2 660	2 510	1 340	1 830	1 830
800	2 490	2 620	2 500	1 365	1 790	1 790
1 000	2 480	2 600	2 490	1 380	1 760	1 760
1 200	2 480	2 580	2 490	1 200	1 730	1 730
1 500	2 480	2 550	2 480	1 415	1 700	1 700
2 000	2 480	2 500	2 480	1 440	1 660	1 660
3 000	2 470	2 470	2 470	1 500	1 600	1 600
>5 000	2 460	2 460	2 460	1 600	1 600	1 600

REMARKS:

1. H AND B IS THE REQUIRED HORIZONTAL CLEARANCE ON THE HIGH LEG OF THE CURVE BASED ON MINIMUM CANT.
2. L AND C IS THE REQUIRED HORIZONTAL CLEARANCE ON THE LOW LEG OF THE CURVE BASED ON MAXIMUM CANT.
3. INTERMEDIATE VALUES MAY BE INTERPOLATED BY THE ENGINEER IN CHARGE.
4. FOR WORKSHOP AREAS AND TEMPORARY WORK, CLEARANCES H AND L MAY BE REDUCED BY 300mm.
5. SEE ANNEXURE 1 SHEET 3 FOR PLATFORM CLEARANCES. H AND L
6. ALSO REFER TO REMARKS 4 TO 8 OF ANNEXURE 1 SHEET 2.
7. USE SMALLER RADIUS IF RADIUS IN BETWEEN

VERTICAL CLEARANCES :
1 065mm TRACK GAUGE

ANNEXURE 1
SHEET 2 of 5

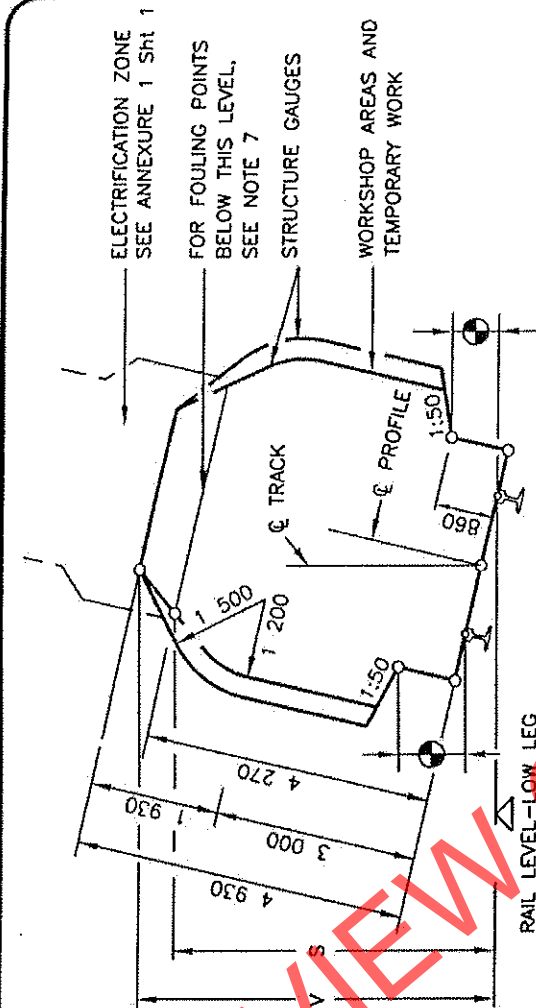

LOCATION	RADIUS (mm)	ELECTRIFIED (PRESENT OR FUTURE)	
		3kV & 25kV	50kV
• OVER OR NEAR POINTS AND CROSSING IF REQUIRED BY ELECTRICAL IRRESPECTIVE OF RADIUS	100	S (mm)	V (mm)
	300	4 470	5 400
	600	4 410	5 370
	1 000	4 370	5 350
	1 500	4 350	5 340
	2 000	4 310	5 310
	>3 000	4 290	5 290
		4 270	5 280
		5 650	6 000

ALL AREAS OTHER THAN THOSE INDICATED BY • BELOW

- REMARKS:
- V IS THE REQUIRED VERTICAL CLEARANCE EXCEPT WHERE REDUCED CLEARANCE S APPLIES.
 - S IS THE MINIMUM VERTICAL CLEARANCE FOR STRUCTURES AND TEMPORARY WORK OVER NON-ELECTRIFIED LINES.
 - INTERMEDIATE VALUES MAY BE INTERPOLATED BY THE ENGINEER IN CHARGE.
 - FOR APPLICATION AT CURVES
 - 1 APPLY INCREASED CLEARANCES FOR CURVES TO POINTS 3m BEYOND THE ENDS OF THE CIRCULAR CURVE.
 - 2 REDUCE CLEARANCES AT A UNIFORM RATE OVER THE REMAINDER OF THE TRANSITION CURVE.
 - 3 FOR NON-TRANSITIONED CURVES REDUCE AT A UNIFORM RATE OVER A LENGTH OF 15m ALONG STRAIGHTS.
 - NEW STRUCTURES: SEE BRIDGE CODE.
 - TUNNELS: SEE DRAWING BE 82-35.
 - FOULING POINTS: SEE CLAUSE 8.1.
 - CLEARANCES ARE BASED ON 15m BOGIE CENTRES AND 21.2m VEHICLE BODY LENGTH.
 - SEE ANNEXURE 1 SHEET 3 FOR PLATFORM CLEARANCES.

CLEARANCES : PLATFORMS

ANNEXURE 1
SHEET 3 of 5

PLATFORMS : TRACK GAUGE 1 065mm

PASSENGERS

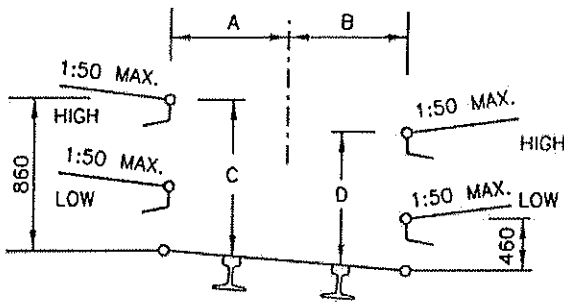

GOODS

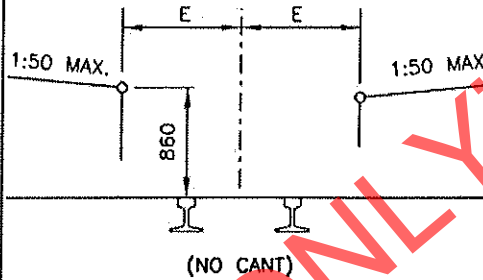

RADIUS (m)	A (mm)	B (mm)	C (mm)	D (mm)	E (mm)
90	1 690	1 820	890	810	1 840
100	1 650	1 790	890	810	1 810
120	1 610	1 740	890	810	1 760
140	1 580	1 700	890	810	1 720
170	1 550	1 660	890	810	1 690
200	1 530	1 630	890	820	1 670
250	1 520	1 600	890	820	1 640
300	1 520	1 580	890	830	1 620
350	1 520	1 560	880	830	1 600
400	1 520	1 550	880	840	1 590
500	1 520	1 540	880	850	1 580
600	1 520	1 530	870	850	1 570
800	1 520	1 520	860	860	1 560
1 200	1 520	1 520	860	860	1 550
2 000	1 520	1 520	860	860	1 540
3 000	1 520	1 520	860	860	1 530
STRAIGHT	1 520	1 520	860	860	1 520

REMARKS:

1. NO CANT TO BE APPLIED EXCEPT WHEN THE GOODS PLATFORM IS ON A RUNNING LINE.
2. INTERMEDIATE VALUES MAY BE INTERPOLATED BY THE ENGINEER IN CHARGE.
3. 8m TO MAIN STATION-BUILDINGS AND 3m TO ALL OTHER STRUCTURES.
4. TOLERANCES : SEE CLAUSE 8.0.10.
5. ALWAYS USE THE SMALLEST RADIUS

STRUCTURES ON PLATFORMS : 1 065mm AND 610mm TRACK GAUGE

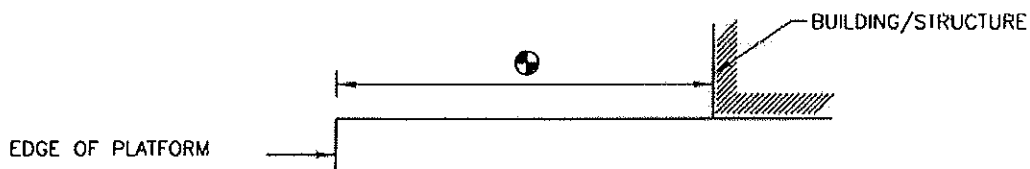

CLEARANCES : 610mm TRACK GAUGE

ANNEXURE 1
SHEET 5 of 5

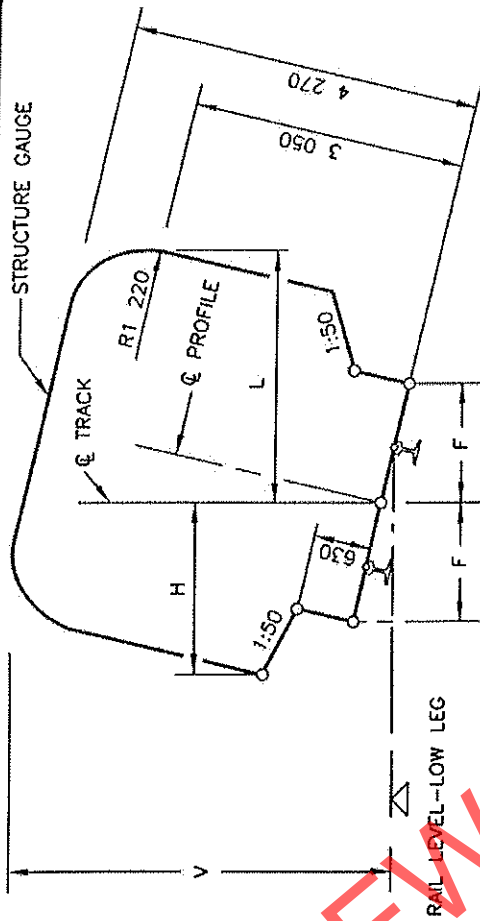

RADIUS (m)	F (mm)
50	1 550
60	1 510
80	1 460
100	1 430
120	1 410
140	1 390
170	1 380
200	1 370
250	1 360
300	1 350
600	1 330
1 000	1 320
>2 000	1 320
STRAIGHT	1 310

RADIUS (m)	WITH CANT		NO CANT
	H (mm)	L (mm)	H & L (mm)
50	2 370	2 490	2 400
70	2 310	2 420	2 350
100	2 260	2 370	2 280
140	2 220	2 340	2 250
200	2 200	2 300	2 220
300	2 190	2 270	2 200
500	2 180	2 230	2 190
700	2 170	2 200	2 180
1 000	2 170	2 170	2 170
>2 000	2 160	2 160	2 160

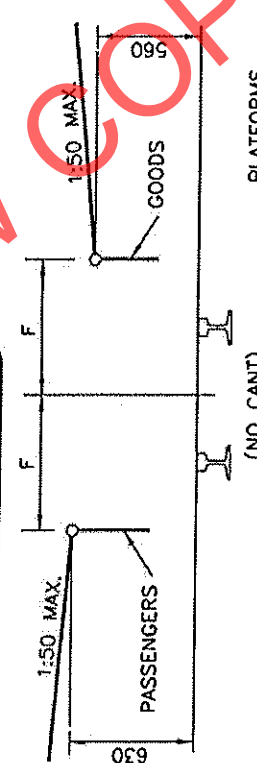

REMARKS:

- H IS THE MINIMUM HORIZONTAL CLEARANCE ON THE OUTSIDE OF THE CURVE BASED ON MINIMUM CANT.
- L IS THE MINIMUM HORIZONTAL CLEARANCE ON THE INSIDE OF THE CURVE BASED ON MAXIMUM CANT.
- V IS THE MINIMUM VERTICAL CLEARANCE.
- FOR APPLICATION AT CURVES:
 - 1 APPLY INCREASED CLEARANCES FOR CURVES TO POINTS 2m BEYOND THE ENDS OF THE CIRCULAR CURVE.
 - 2 REDUCE CLEARANCES AT A UNIFORM RATE OVER THE REMAINDER OF THE TRANSITION CURVE.
 - 3 FOR NON-TRANSITIONED CURVES REDUCE AT A UNIFORM RATE OVER A LENGTH OF 18m ALONG STRAIGHTS.
- INTERMEDIATE VALUES MAY BE INTERPOLATED BY THE ENGINEER IN CHARGE.
- ALSO REFER TO REMARKS 5, 6 AND 7 OF ANNEXURE 1 SHEET 2.
- CLEARANCES ARE BASED ON 9 700mm BOGIE CENTRES AND 13 700mm VEHICLE BODY LENGTH.
- SEE ANNEXURE 1 SHEET 3 FOR STRUCTURES ON PLATFORMS.

Messrs: _____
AT : _____

SERVICE LEVEL AGREEMENT FOR: -

Contract: _____; Purchase Order: _____

Cleaning of _____

TRANSNET



SERVICE LEVEL AGREEMENT (SLA)

entered between

TRANSNET LIMITED

(Registration no.1990/000900/30)

trading as Transnet Freight Rail

and

“PREVIEW COPY ONLY”

Messrs: _____
AT : _____

TRANSNET



SERVICE LEVEL AGREEMENT FOR: -
Contract: _____; **Purchase Order:** _____
Cleaning of _____

Table of Contents

1. INTRODUCTION

1.1 Purpose

1.2 Scope

1.3 Parties to agreement

1.4 Term

2. SERVICES TO BE DELIVERED

2.1 The services

2.2 Business hours and service

2.3 Uniforms

2.4 Register of cleaning behind doors

3. PERFORMANCE MEASURES, TRACKING AND REPORTING

3.1 Service level measurements

3.2 Criteria to measure targets

3.3 Tracking and reporting performance

3.3.1 Reporting template – example

3.3.2 Absenteeism – Cleaner Absent

4. PROBLEM MANAGEMENT

5. PENALTY CLAUSE

5.1. Financial Penalty and Parameters

1. INTRODUCTION

1.1 PURPOSE

Messrs: _____
AT : _____



SERVICE LEVEL AGREEMENT FOR: -
Contract: _____; **Purchase Order:** _____
Cleaning of _____

The purpose of this SLA is to ensure sound procedures and standards against which the performance of both parties can be objectively evaluated on a regular basis. The SLA will define the services, the indicators associated with these services, acceptable and unacceptable service levels, liabilities on the part of the service provider and the customer, and actions to be taken in specific circumstances.

1.2 SCOPE

The SLA documents the agreed procedures to be followed by both parties in the provision of cleaning services and the agreed standards to which the service will be performed to ensure continuity of the cleaning services.

1.3 PARTIES TO THE AGREEMENT

The following table describes and names the entities and their representatives who have reviewed and approved this SLA.

Entity	Name and surname	Contact No (land & cell)	Email	Role

1.4 TERM (PERIOD)

The term of this SLA shall be as follows:

Start Date: _____

End Date: _____

Duration: _____

Once agreed Service Provider and Transnet Freight Rail cannot withdraw from all or part of this agreement within the above dates, unless the agreement is mutually or legally terminated

2. SERVICES TO BE DELIVERED

The successful Tenderer undertakes and agrees to render a cleaning service to Transnet Freight Rail in terms of the agreed standards as per the tender and the mutually concluded SLA agreement.

2.1. THE SERVICES (OUTCOMES)

Messrs: _____
 AT : _____

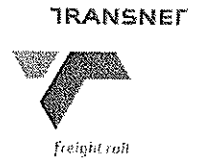

SERVICE LEVEL AGREEMENT FOR: -
Contract: _____ ; **Purchase Order:** _____
Cleaning of _____

What do we insert here? - A clear and unequivocal definition of the details of the required service (who does what, when)

Description	Frequency	Restrictions / Comments

2.2 BUSINESS HOURS AND SERVICE

The official business hours at Transnet Park is 07h30 to 16h00. The cleaning personnel must remember to report as per the hours in the contract viz. 07h00 to 16h30

The following locations work 24/7

When cleaning personnel do not report for work or proceed on sick or ordinary leave another cleaner must be seconded to that area to ensure continuity – the area will be services uninterrupted.

2.3. UNIFORMS

All cleaning personnel will wear uniforms that identify them as an employee of the cleaning company plus a name badge.

2.4. REGISTER OF CLEANING BEHIND DOORS

A cleaning register must be hung behind the doors.

3. PERFORMANCE MEASURES, TRACKING AND REPORTING

The under mentioned and other mutually agreed on measures will be used to assess the performance of the service:

3.1 SERVICE LEVEL MEASUREMENTS

The following measures will be used to assess the performance of the service:

Measure KPA	Frequency	Description	Service Goal
Quality of Cleaning	Monthly	The quality must be performed as per the specifications	90%

Messrs: _____
 AT : _____



SERVICE LEVEL AGREEMENT FOR: -

Contract: _____ ; Purchase Order: _____

Cleaning of _____

Service Performance	Monthly	The service must be performed as per the specifications	90%
Client Satisfaction	Monthly	The service must be performed by a certain time.	90%
Supervision Satisfaction	Monthly	Supervision must be available and visible at agreed times	80%
Overall Service	Monthly	Combination of the above elements	80%

3.2 CRITERIA TO MEASURE TARGETS

The following criteria will be utilized to determine the achievement of the target for the period to be measured

Any repetition of the same transgression will lead to the mechanism for dismissal of the contractor

Measure	Actual Performance	Weight	Measurement Formula															
Standard and quality of Cleaning	<p>The quality must be in terms of the specifications and is based on replenishment of consumables to the various locations of: -</p> <ul style="list-style-type: none"> • Cleaning materials and equipment to perform duties • Soaps, hand paper towels and toilet paper • Availability & replacement of health and sanitation products <p>Using the placement of consumables as a criteria allows one to quantify quality</p>	30%	<p>100% minus # of rejects</p> <p>The non replenishment of consumables at a specific location will be recorded as one reject. If there are 10 locations and 2 locations were not replenished then the reject rate = 20%</p>															
Service Performance	<p>The service performance will be in terms of the specifications and is based on the actual cleaning of the various locations per day, week or month at the various locations of: -</p> <ul style="list-style-type: none"> • On time cleaning of the locations for that period • Cleaning of location to satisfaction of the client • Availability & replacement of health and sanitation products • Cleaner on site on time <p>Using the placement of consumables as a criteria allows one to quantify quality</p>	30%	<p>100% minus 5% for each failure</p> <p>One failure to clean a specific location = 5% and means the non or substandard cleaning of the location</p>															
Client Satisfaction	<p>The client in the various locations will participate in the measurement via written feedback:-</p> <ul style="list-style-type: none"> • The satisfaction level experienced by the clients based on services performed and supervision attentiveness by the contractor. • The measurement will be based on the same targets for Standard 	20%	<p>100% minus % scored</p> <p>Objective : Agree on satisfaction levels</p> <table border="1"> <thead> <tr> <th>Rating Scale description</th> <th>Rating scale</th> <th>Performance Standard</th> </tr> </thead> <tbody> <tr> <td>Far Exceeding</td> <td>100</td> <td></td> </tr> <tr> <td>Exceeds</td> <td>95</td> <td></td> </tr> <tr> <td>Meets</td> <td>90</td> <td></td> </tr> <tr> <td>Below Standard</td> <td>85</td> <td></td> </tr> </tbody> </table>	Rating Scale description	Rating scale	Performance Standard	Far Exceeding	100		Exceeds	95		Meets	90		Below Standard	85	
Rating Scale description	Rating scale	Performance Standard																
Far Exceeding	100																	
Exceeds	95																	
Meets	90																	
Below Standard	85																	

Messrs: _____
 AT : _____



SERVICE LEVEL AGREEMENT FOR: -
Contract: _____; Purchase Order: _____
Cleaning of _____

	and quality of cleaning and Supervision		Does not meet	80																						
Supervision Satisfaction	<p>Supervision must be available and visible at agreed times</p> <ul style="list-style-type: none"> The visibility of the supervisor to the contractors cleaning personnel and attending to any request for needs to enable them to perform the services Sign off of Checklists by supervisor to be available behind doors or other agreed place Supervisor site visits on agreed dates and times and remedies poor performance The availability and visibility of the supervisor to the contractors cleaning personnel 	20%	<p>100% minus % Supervision Satisfaction is construed as willingness & proficiency to Assist, Solve Problems, Sign checklists, provide alternatives, Demonstrate Service Orientation</p> <p>Objective : Provide acceptable service levels</p> <table border="1"> <thead> <tr> <th>Rating Scale description</th> <th>Rating Scale</th> <th>Performance Standard</th> </tr> </thead> <tbody> <tr> <td>Excellent</td> <td>100</td> <td></td> </tr> <tr> <td>Far Exceeding</td> <td>90</td> <td></td> </tr> <tr> <td>Exceeds</td> <td>85</td> <td></td> </tr> <tr> <td>Meets</td> <td>80</td> <td></td> </tr> <tr> <td>Below Standard</td> <td>75</td> <td></td> </tr> <tr> <td>Does not meet</td> <td>60</td> <td></td> </tr> </tbody> </table>			Rating Scale description	Rating Scale	Performance Standard	Excellent	100		Far Exceeding	90		Exceeds	85		Meets	80		Below Standard	75		Does not meet	60	
Rating Scale description	Rating Scale	Performance Standard																								
Excellent	100																									
Far Exceeding	90																									
Exceeds	85																									
Meets	80																									
Below Standard	75																									
Does not meet	60																									

Once weights and criterion have been determined the actual results are measured – see 3.3 for an example

3.3 TRACKING AND REPORTING PERFORMANCE

All roles players will be issued with the one pager Supplier Performance Document (SPD). The SPD will be completed for every incident that is not in compliance with the SLA and contract. The SPD will be completed monthly by all role players and be submitted to the Project Manager. In the event there being no Project Manager the SPD will be submitted to TFR SCS. The Service Provider representative must sign every SPD where non performance is recorded.

3.3.1. REPORTING TEMPLATE - EXAMPLE

Measure KPA	Weight	Actual Performance	Performance Evaluation	Result
Quality (90%)	30%	5 rejects	$30 \times (1.00 - 0.05) =$	28,5
Service (90%)	30%	3 failures	$30 \times [1.00 - (0.05 \times 3)] =$	25,5
Client Satisfaction (90%)	20%	90	$20 \times (1.00 - 0.1) =$	18
Supervisory Satisfaction (80%)	20%	80	$20 \times (1.00 - 0.2) =$	16
Total score				86%

How do we determine if the service goal per KPA was met for the period?

Example:

Messrs: _____
 AT : _____

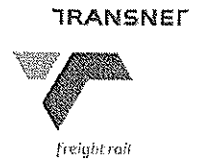

SERVICE LEVEL AGREEMENT FOR: -
Contract: _____; Purchase Order: _____
Cleaning of _____

There was 5 rejects for quality – how do we determine what % that is as the service goal = 90% for Quality

$$= 100 \times (1.00 - 0.05) = 95\%$$

When service falls below the thresholds identified TFR (Project Manager) and Service Provider will work to resolve service problems. In the event that the service does not improve a joint meeting with TFR SCS will convene. The TFR Project Manager will invite all role players. The meeting will be used to discuss and resolve problems that resulted in diminished service to TFR

A comprehensive report that documents all the results and resolutions of these problems / findings shall be minuted and distributed to the Procurement Manager and other affected Managers

3.3.2 Absenteeism - Cleaner Absent

1. Turnaround time to replace a worker who is absent = 2 Hours
2. Successful Tenderer must immediately contact the Project Manager AND the relevant representative of that location
3. The above is considered as breach of contract and will be recorded as an event on the Performance Report if no replacement is made within the agreed upon time frame

4. PROBLEM MANAGEMENT

The respective parties will work to resolve issues at the lowest possible level. To achieve this, TFR and the Contractor will formulate procedures relating to:

- Courses of action to take in the event of a problem
- Early identification of problems and proposed solutions
- Provision of services outside normal working hours

What is expected from the service provider in terms of suggestions and recommendations for service enhancement, cost containment, etc?

Below is a sample Joint Action Planning Template

Performance Area	Comments/Issues	Agreed Action	Responsibility for Delivery	Deadline
Quality				
Service				
Client Satisfaction				
Supervisor Satisfaction				
Contractual				
Representatives				

Messrs: _____
AT : _____



SERVICE LEVEL AGREEMENT FOR: -
Contract: _____ ; Purchase Order: _____
Cleaning of _____

5. PENALTY CLAUSE

In the event that the contractor *is unable to or fails to provide the required service and quality of products* on a specific day, TFR reserves the right to employ another Supplier at the expense of Contractor. All additional expenses incurred to arrange for an alternative Supplier will be for the account of the Contractor.

5.1 Financial Penalty and Parameters

In the event that the Contractor damages, fails to perform a cleaning service in a specific area; deliver or supplies inferior quality products or services in terms of the Performance agreement, a financial penalty as agreed to by both parties, will be imposed.

Performance Area	Reason for financial penalty	Financial Penalty
Quality		
Service		
Client Satisfaction		
Supervisory Satisfaction		
Non Compliance with contract		

The penalty will consider and reflect the service goals and will be agreed to by SCS and the contractor.

5.2 Continued poor Service or failure to perform

Should the contractor fail to achieve the service goal with in xxx months, Transnet reserves the right to invoke the termination clause of the contract.

“PREVIEW COPY ONLY”

Messrs: _____
AT : _____

TRANSNET



SERVICE LEVEL AGREEMENT FOR: -
Contract: _____ ; **Purchase Order:** _____
Cleaning of _____

Signed at _____ on this _____ day of
_____ 2011

.....
For **Transnet Ltd**

As Witnesses

.....

.....

Signed at _____ on this _____ day of
_____ 2011

.....
For **Successful Tenderer**

As witnesses

.....
SUPPLIER PERFORMANCE DOCUMENT
(To be completed monthly by representative from the various offices / locations)