



ADDENDUM NO. 1 TO THE E 7/1 (JULY 1998)

SPECIFICATION FOR WORKS ON, OVER, UNDER OR ADJACENT TO RAILWAY LINES AND NEAR HIGH VOLTAGE EQUIPMENT.

Clause 13 Blasting.

Delete this clause in its entirety

Clause 17 General.

Sub-clause 17.1

Include the words "on request only" after the word "contract" in the fourth line.

Clause 27 Blasting.

Delete this clause in its entirety

“PREVIEW COPY ONLY”



GENERAL TENDER CONDITIONS - SERVICES

FORM CSS5

INDEX		
SUBJECT	CLAUSE NUMBER	PAGE NUMBER
GENERAL.....	1	2
LODGING OF TENDERS.....	2	2
USE OF TENDER FORMS.....	3	2
THE RAISING OF A CHARGE FOR PLANS, SPECIFICATIONS, AND TENDER FORMS	4	2
DEFAULTS BY RESPONDENTS.....	5	2
CURRENCY.....	6	4
EXCHANGE AND REMITTANCE.....	7	4
ACCEPTANCE OF TENDER OR QUOTATION.....	8	4
LAW GOVERNING CONTRACT.....	9	5
IDENTIFICATION.....	10	5
FORMAL NOTIFICATION REGARDING NAME OF SUCCESSFUL RESPONDENT.....	11	5
UNAUTHORISED COMMUNICATION ABOUT TENDERS.....	12	5
CONTRACT DOCUMENTS.....	13	6
SECURITIES.....	14	6
PRICES SUBJECT TO CONFIRMATION.....	15	6
DELETION OF SERVICES EXCLUDED FROM OFFER/BID.....	16	6
ALTERATIONS MADE BY THE RESPONDENT TO TENDERED PRICES... ..	17	7
VALUE-ADDED TAX.....	18	7
TERMS AND CONDITIONS OF TENDER.....	19	7
IMPORTANT NOTICE TO RESPONDENTS REGARDING PAYMENT.....	20	7
PLANS, DRAWINGS, DIAGRAMS, SPECIFICATIONS AND DOCUMENTS..	21	8
VISITS TO FOREIGN COUNTRIES.....	22	8
TENDERS BY FOREIGN RESPONDENTS OR ON THEIR BEHALF.....	23	9

1. GENERAL

All tenders and subsequent contracts and orders shall be subject to the following procedures as laid down by Transnet Limited (hereinafter referred to as “Transnet”) and are to be strictly adhered to by any person or enterprise or company responding to this tender (hereinafter referred to as “Respondents” or the “Respondent”).

2. LODGING OF TENDER

2.1 Tenders shall be lodged with Transnet no later than the closing date and time specified for the receipt thereof, in accordance with the directions issued with tender documents.

2.2 Tenders shall be transmitted in a sealed envelope and placed in the Tender Box at a venue stipulated in the Request for Tender (RFT) or Request for Proposal (RFP) or Request for Quotation (RFQ) (collectively “Tender Documents”), with the tender number and subject endorsed on the left hand bottom corner of the envelope.

3. USE OF TENDER FORMS

Where special forms are issued by Transnet for the submission of tenders, Respondents are required to submit their tenders by completion of the appropriate sections on such official forms and not on office stationery bearing their own special conditions of tender; non-compliance with this conditions may result in the rejection of a tender.

4. THE RAISING OF A CHARGE FOR PLANS, SPECIFICATIONS AND TENDER FORMS

4.1 A non-refundable charge may be raised for Tender Documents, depending on the nature, magnitude and value of technical information supplied.

4.2 If any of the drawings and specifications referred to in Tender Documents are the official publications of recognised standardising bodies, copies of such drawings and specifications shall be acquired by Respondents at their own expense.

5. DEFAULTS BY RESPONDENTS

5.1 If the Respondent, after it has been notified of the acceptance of its tender/quotation fails to:

- (a) enter into a formal contract when called upon to do so in terms of clause 13 (*Contract Documents*), within such period as Transnet may specify; or
- (b) accept an order in terms of the tender or quotation; or
- (c) when called upon to do so, furnish satisfactory security of the fulfilment of the contract in terms of clause 14 (*Securities*);

Transnet may, in any such case, without prejudice to any other legal remedy which it may have, proceed to accept any other tender or quotation or, if it is necessary to do so, call for

Respondent's Signature

Date & Company Stamp

tenders or quotations afresh, and may recover from the defaulting Respondent any additional expense incurred by it in calling for new offers or in accepting a higher offer.

5.2 If any Respondent, who has submitted a tender or quotation, concluded a contract with Transnet (hereinafter referred to as "the Supplier"), or in the capacity of agent or subcontractor has been associated with such tender or contract -

- (a) has withdrawn such tender/quotation after the advertised date and hour for the receipt of tenders; or
- (b) has, after having been notified of the acceptance of its tender or quotation, failed or refused to sign a contract when called upon to do so in terms of any condition forming part of the tender documents; or
- (c) has carried out any contract resulting from such tender or quotation in an unsatisfactory manner or has breached any condition of such contract; or
- (d) has offered, promised or given a bribe in relation to the obtaining or the execution of such contract; or
- (e) has acted in a fraudulent or improper manner or in bad faith towards Transnet or any government department or towards any public body, company or person; or
- (f) has made any incorrect statement in the affidavit or certificate referred to in clause 11 (*Formal Notification Regarding Name of Successful Respondent*) and is unable to prove to the satisfaction of Transnet that
 - (i) it made the statement in good faith honestly believing it to be correct; and
 - (ii) before making such statement, it took all reasonable steps to satisfy itself of its correctness; or
- (g) caused Transnet damage, or to incur costs in order to meet the Supplier's requirements which could not be recovered from the Supplier;

then a tender from any such Respondent shall be disqualified and the person, enterprise or company (including any directors) shall, subject to clause 5.3 below, be disqualified from tendering for any Transnet business.

5.3 Any person or enterprise or company against whom a decision has been given under the provisions of sub-clauses 5.2(b), 5.2(d) or 5.2(e) above, may make representations to the Chief Operating Officer of Transnet Group, whose decision shall be final.

5.4 Any disqualification imposed upon any person or enterprise or company, unless Transnet determines otherwise, shall apply to any other enterprise under the same or different names of disqualified persons or enterprise or company (or associates thereof) and shall for avoidance of doubt also be applied to any agent or employee of the person or enterprise or company concerned.

Respondent's Signature

Date & Company Stamp

6. CURRENCY

Prices or fees must be quoted in the currency of the Republic of South Africa in respect of local Services. Prices or fees in any other currency may be rejected by Transnet save where such price is quoted by a foreign Respondent.

7. EXCHANGE AND REMITTANCE

The Respondent should note that where the whole or a portion of the contract or order value is to be remitted overseas, Transnet shall, if requested to do so by the Supplier, effect payment overseas directly to the foreign principal or service provider of such percentage of the contract or order value as may be stipulated by the Respondent in its Tender Documents and any variation in the amount to be so paid, which may arise as a result of fluctuations in the rate of exchange involved, will be for the account of the Supplier.

7.1 The Respondent who desires to avail itself of the aforementioned facility must at the time of tendering furnish the information called for in the clause "Exchange and Remittance" of the Tender Documents and also furnish full details of the principals or service providers to whom payment is to be made.

7.2 The Supplier shall at its own cost obtain forward exchange cover on foreign currency to protect itself against any currency rate fluctuation risks for the duration of any resulting contract or order. Transnet will NOT accept any fluctuations in the rate of exchange at the time when payments are made.

Transnet will not recognise any claim for adjustment of the order and/or contract price under clause 7.2 above, if the increase in price arises after the date on which the Services were to be delivered, as set out in the order and/or contract, or any subsequent agreement between the parties.

8. ACCEPTANCE OF TENDER OR QUOTATION

8.1 Transnet does not bind itself to accept the lowest or any tender or quotation nor will it give any reasons for the rejection of a tender or quotation. Transnet reserves the right to accept any tender in whole or in part.

8.2 Upon the acceptance of a tender or quotation by Transnet, the parties shall be bound by these General Tender Conditions and the Standard Terms and Conditions of Contract (Form US7 - Services).

8.3 Where the acceptance by Transnet of the Respondent's offer/bid is delivered by letter, the South African Post Office shall be regarded as the agent of Transnet and delivery of such notice of acceptance to the South African Post Office shall be considered as delivery to the Respondent.

Respondent's Signature

Date & Company Stamp

8.4 Where the Respondent has been informed by Transnet per facsimile message of the acceptance of its tender or quotation, the acknowledgement of receipt transmitted by its facsimile machine shall be regarded as proof of delivery to the Respondent.

9. LAW GOVERNING CONTRACT

The law of the Republic of South Africa shall govern the contract created by the acceptance of a tender/quotation. The *domicilium citandi et executandi* shall be a place in the Republic of South Africa to be specified by the Respondent in its tender/quotation at which all legal documents may be served on the Respondent who shall agree to submit to the jurisdiction of the courts of the Republic of South Africa. A foreign Respondent shall, therefore, state in its tender/quotation the name of its accredited agent in the Republic of South Africa who is empowered to sign any contract which may be entered into in the event of its tender/quotation being accepted and to act on its behalf in all matters relating to the contract.

10. IDENTIFICATION

If the Respondent is a company, the full names of the directors shall be stated in the tender/quotation. If the Respondent is a close corporation, the full names of the members shall be stated in the tender/quotation. If the Respondent is a partnership or an individual trading under a trade name, the full names of the partners or of such individual, as the case may be, shall be furnished.

11. FORMAL NOTIFICATION REGARDING NAME OF SUCCESSFUL RESPONDENT

In the case of tenders submitted to the Secretary of a Divisional Acquisition Council, unsuccessful Respondents will be formally notified of the names of successful Respondent(s) as soon as possible after the closing date for receipt of the tender in question. In the case of tenders or quotations submitted to Transnet Acquisition Council, unsuccessful Respondents shall, upon application, be furnished with similar information.

12. UNAUTHORISED COMMUNICATION ABOUT TENDERS

Where tenders are submitted to the Secretary of an Acquisition Council, Respondents may at any time communicate with the Secretary on any matter relating to its tender but, in the absence of written authority from the Secretary, no communication on a question affecting the subject of a tender shall take place between Respondents or other potential suppliers or any member of the Acquisition Council or official of Transnet during the period between the closing date for the receipt of the tender and the date of the notification of the successful Respondent(s). A tender, in respect of which any such unauthorised communication has occurred, may be disqualified.

Respondent's Signature

Date & Company Stamp

13. CONTRACT DOCUMENTS

The contract documents will comprise these General Tender Conditions and the Standard Terms and Conditions of Contract (Form US7 - Services) which will constitute the contract between the parties upon receipt by the Respondent of Transnet's letter of acceptance / intent, subject to all additional amendments and/or special conditions thereto as agreed to by the parties.

14. SECURITIES

14.1 The successful Respondent, when called upon to do so, shall provide security to the satisfaction of Transnet for the due fulfilment of a contract or order. Such security shall be in the form of a deed of suretyship furnished by an approved bank, building society, insurance or guarantee corporation carrying on business in South Africa.

14.2 The security may be applied in whole or part at the discretion of Transnet to make good any loss or damage which Transnet may incur in consequence of a breach of the contract or any part thereof.

14.3 Such security, if required, shall be an amount which will be stipulated in the Tender Documents.

14.4 For the purpose of clause 14.1 above, Transnet will supply "Deed of Suretyship" forms to the successful Respondent for completion and no guarantee in any other form will be accepted. Copies of such forms will be supplied to Respondents on request. For this purpose "Deed of Suretyship" forms will be provided which shall be completed and returned to Transnet or a designated official by the successful Respondent within 30 (thirty) days from the date of the letter of acceptance. No payment will be made until the forms, duly completed, are delivered to Transnet. Failure to return the Deed of Suretyship within the prescribed time shall, save where prior extension has been granted, entitle Transnet without notice to the Supplier to cancel the contract with immediate effect.

14.5 Additional costs incurred by Transnet necessitated by reason of default on the part of the Supplier in relation to the conditions of this clause 14 will be for the account of the Supplier.

15. PRICES SUBJECT TO CONFIRMATION

15.1 A tender or quotation with prices which are subject to confirmation will not be considered.

15.2 Tenders where firm prices are quoted for the duration of any resulting order and/or contract will receive precedence over prices which are subject to adjustment.

16. DELETION OF SERVICES EXCLUDED FROM OFFER/BID

The Respondent must delete Services for which it has not tendered or for which the price or fee has been included elsewhere in the tender.

Respondent's Signature

Date & Company Stamp

17. ALTERATIONS MADE BY THE RESPONDENT TO TENDERED PRICES

All alterations made by the Respondent to its tendered price(s) prior to the submission of its Tender Documents must be done by deleting the incorrect figures and words where required and by inserting the correct figures and words against the items/Services concerned. All such alterations must be initialled by the person who signs the Tender Documents. Failure to observe this requirement may result in the particular item(s) or Services concerned being excluded in the matter of the award of the business.

18. VALUE-ADDED TAX

18.1 In respect of local Services, i.e. Services to be provided by a South African company, the prices or fees quoted by the Respondent are to be exclusive of Value-Added Tax (VAT) which must be shown separately at the standard rate on the Supplier's Tax Invoice.

18.2 In respect of Services to be provided by a foreign principal -

- (a) The invoicing by a local Supplier on behalf of its foreign principal represents a Service rendered by the principal, which is not subject to VAT;
- (b) The Supplier's Tax Invoice(s) for the local portion only (i.e. the "commission" for the Services rendered locally) must show the Value-Added Tax (VAT) separately at zero percent if the Services are in compliance with Section 11(2) of the VAT Act, 89 of 1991.

19. TERMS AND CONDITIONS OF TENDER

The Supplier shall adhere to the Standard Terms and Conditions of Contract as set out in Form US7 - Services), a copy of which is attached hereto. Should the Respondent find any conditions unacceptable, it should indicate which conditions are unacceptable and offer an alternative. Please note that any alternative offered shall be compared with acceptance of the Form US7 conditions or alternatives offered by other Respondents.

20. IMPORTANT NOTICE TO RESPONDENTS REGARDING PAYMENT

20.1 Method of Payment

- (a) The attention of the Respondent is directed to clause 10 (*Invoicing and Payment*) of Form US7 – Services, which sets out the conditions of payment on which tender price(s) shall be based.
- (b) However, in addition to the foregoing the Respondent is invited to submit offers based on alternative methods of payment and/or financing proposals.
- (c) The Respondent is required to give full particulars of the terms that will be applicable to its alternative offer(s) and the financial merits thereof will be evaluated and taken into consideration when the tender is adjudicated.

Respondent's Signature

Date & Company Stamp

- (d) The Respondent must, therefore, in the first instance, tender strictly in accordance with sub-clause 20.1(a) above. Failure to comply with sub-clause 20.1(a) above may preclude a tender from further consideration.

NOTE: The successful Respondent (the Supplier) shall, where applicable, be required to furnish a guarantee covering any advance payments.

20.2 Conditional Discount

Respondents offering prices which are subject to a conditional discount applicable for payment within a specific period are to note that the conditional period will be calculated as from the date of receipt by Transnet of the Supplier's month-end statement reflecting the relevant Tax Invoice(s) for payment purposes, provided the conditions of the order or contract have been fulfilled and the Tax Invoice is correct in all respects as referred to in the contract or order. Incomplete and/or incorrect Tax Invoices shall be returned and the conditional period will be recalculated from the date of receipt of the correct documents.

21. PLANS, DRAWINGS, DIAGRAMS, SPECIFICATIONS AND DOCUMENTS

Copyright in plans, drawings, diagrams, specifications and documents compiled by the Supplier for the purpose of contract work shall be governed by the terms and conditions detailed in clause 12 of Form US7 - Services (*Intellectual Property Rights*).

22. VISITS TO FOREIGN COUNTRIES

22.1 Respondents must furnish details in a covering letter if it is considered necessary that employees of Transnet should carry out inspection and/or review any operational Services at the premises of the successful Respondent (the Supplier) or its subcontractors overseas for the purpose of a product demonstration and/or final acceptance or for any other reason.

22.2 If the Respondent considers overseas visits to be necessary it must provide the following information in a covering letter in respect of each visit -

- (a) countries and places to be visited;
- (b) number of employees and disciplines involved;
- (c) number of man-days involved; and
- (d) motivation for the visit.

22.3 Transnet will make all arrangements with regard to booking of air journeys, hotel reservations, transport to and from airports, places of inspection or demonstration, etc. and all expenses will be for the account of Transnet.

22.4 Before a visit is undertaken, such as envisaged in this clause 22, Transnet and the Supplier will agree in writing on the number of employees of Transnet that should undertake the visit and the number of man-days involved in the visit.

Respondent's Signature

Date & Company Stamp

23. TENDERS BY FOREIGN RESPONDENTS OR ON THEIR BEHALF

- 23.1 Tenders submitted by foreign principals may be forwarded direct by the principals to the Secretary of the Acquisition Council or to a designated official of Transnet according to whichever officer is specified in the Tender Documents, or may be so forwarded on the principal's behalf by its South African representative and/or agent provided that written proof is submitted that such representative / agent has been duly authorised to act in that capacity by the principal. Failure to submit such authorisation by the representative / agent shall disqualify the tender.
- 23.2 When legally authorised to prepare and submit tenders on behalf of their principals not domiciled in the Republic of South Africa, representatives and/or agents must compile the tenders in the names of such principals and sign them on behalf of the latter.
- 23.3 South African representatives and/or agents of successful foreign Respondents must when so required enter into a formal contract in the name of their principals and must sign such contracts on behalf of the latter. In every such case a legal Power of Attorney from their principals must be furnished to Transnet by the South African representative and/or agents authorising them to enter into and sign such contracts.
- (a) Such Powers of Attorney must comply with Government Notice No. 1160 of 27 June 1930 (and any amendments thereto) - "Rules of the Supreme Court of South Africa for the authentication of documents executed outside the Republic for use within the Republic."
 - (b) The Powers of Attorney must be signed by principals under the same title as used in the Tender Documents.
 - (c) On arrival within the Republic of South Africa these Powers of Attorney are to be completed in terms of Section 8(2) of the Stamp Duties Act No. 77 of 1968, or any amendment thereof.
 - (d) If a Power of Attorney held by the South African representative or agent includes matters of a general nature besides provision for the entering into and signing of contracts with Transnet, a notarially certified copy thereof should be furnished.
 - (e) The Power of Attorney must authorise the South African representative or agent to choose the *domicilium citandi et executandi* as provided for in clause 26 (*Addresses for Notices*) of the Standard Conditions of Contract, Form US7 - Services.
- 23.4 If payment is to be made in South Africa, the foreign Supplier (i.e. the principal, or its South African agents or representatives), must notify Transnet in writing whether -
- (a) For payment by cheque –

Respondent's Signature

Date & Company Stamp

- (i) cheques are to be drawn for payment to the credit of the foreign Supplier's account at a bank in South Africa, in which case the name and branch of such bank shall be furnished; or
 - (ii) cheques are to be made out in favour of the foreign Supplier and forwarded to its South African agent or representative, in which case such agent or representative must be duly authorised to sign the receipt of the cheque and discharge it on behalf of its principal.
- (b) For payment by electronic funds transfer (EFT) –
- (i) funds are to be transferred to the credit of the foreign Supplier's account at a bank in South Africa, in which case the name and branch of such bank shall be furnished; or
 - (ii) funds are to be transferred to the credit of its South African agent or representative, in which case the name and branch of such bank shall be furnished

23.5 The attention of the Respondent is directed to clause 14 above (*Securities*) regarding the provision of security for the fulfilment of contracts and orders and the manner and form in which such security is to be furnished.

oooo000oooo

“PREVIEW COPY ONLY”

Respondent's Signature

Date & Company Stamp

MINIMUM COMMUNAL HEALTH REQUIREMENTS IN AREAS OUTSIDE THE JURISDICTION OF A LOCAL AUTHORITY : TEMPORARY FACILITIES FOR CONTRACTOR'S PERSONNEL

1. CAMPS

- 1.1 Prior to the erection of any camp, the Contractor shall submit to the Technical Officer, for his approval, details of his proposals as to the site, water supply, sanitation, and size and type of buildings. Where the site is on private land, the Contractor shall submit the written approval for the use of the site of the relevant statutory authority and of the owner and occupier of the land (as applicable).
- 1.2 Camps must not be erected on land infested with field rodents.
- 1.3 Adequate drainage shall be provided to carry off storm and waste water.
- 1.4 Buildings shall be built to a neat and orderly pattern.
- 1.5 All buildings shall have smooth, hard, impervious floors, graded to provide effective drainage and to permit washing.
- 1.6 Camps shall be maintained by the Contractor at his own expense in a clean and tidy condition. The Contractor shall take such steps as the Technical Officer and landowner/occupier may demand to prevent the creation of a nuisance.
- 1.7 When so instructed by the Technical Officer, the Contractor shall, at his own expense, erect suitable screens between the camp and any public road, thoroughfare or railway line.
- 1.8 After removal of a camp, the Contractor shall, at his own expense, restore the site to its original condition to the satisfaction of the Technical Officer and of the landowner and occupier where the site is on private land.

2. HOUSING

- 2.1 Every living room shall have cross ventilation, both constant and occasional. Where only one window is provided, it shall not be in the same wall as the door.
- 2.2 Dimensions of living rooms shall be sufficient to allow 3.5 square metres of floor area and 11 cubic metres of air space for each person over the age of 10 years. The floor area of any living room shall not be less than 7,8 square metres.

- 2.3 Flat-roofed quarters shall have a minimum roof height of 3 metres above floor level. For quarters with pitched roofs, the wall height shall be not less than 2,6 metres above the floor with a minimum height above floor of 3 metres at the top of the pitch.
- 2.4 Doors shall not be less than 2m x 0,75m and must be halved.
- 2.5 Windows of each living room shall have an area not less than one twelfth of the floor area and shall be capable of opening to at least half their full area.
- 2.6 In areas where malaria is prevalent, doors and windows must be fitted with gauze screens.
- 2.7 Cooking shelters shall comprise roofed structures, three sides of which shall be enclosed by a weatherproof material, approved by the Technical Officer to a height of at least **1m** above ground level.
- 2.7.1 Sleeping quarters shall not accommodate more than 8 persons per room.
- 2.7.2 Pegboards shall be carried on metal or concrete supports and shall be separated by partitions not less than 0,4 metres high extending to within 150mm of the end of the bunk. Pegboards shall be removable for cleaning.

3. WATER SUPPLY AND ABLUTION FACILITIES

- 3.1 The Contractor shall ensure that an adequate and conveniently situated supply of potable water is provided.
- 3.2 Separate buildings for ablution facilities shall be provided. Where approval has been obtained for the housing of both males and females, separate facilities for each sex shall be provided. The proportion shall be 1 cubicle for 20 persons.
- 3.3 Waste water shall be hygienically disposed of.

4. SANITATION

- 4.1 Separate buildings for latrine facilities shall be provided. Where housing are provided for both males and females, separate facilities for each sex shall be provided. The proportions shall be at least one squatting seat for every 15 persons or less in the case of pit latrines, or one for every 10 persons or less in case of pail latrines.

Latrines shall be fly proof and sited at least 10 metres from any other building, and shall not face on any public road, thoroughfare, railway line or residential property. Pits shall not be less than 2,5 metres deep and sited not less than 120 metres from nearest underground water source.

- 4.2 Latrines shall be so constructed, situated and maintained, and night soil so disposed of as to prevent access by animals, breeding of flies, pollution of streams and domestic water supplies, and other nuisances. Where a night soil removal service is operated by

a competent authority, use of such service shall be obligatory, and the use of pit latrines and atria pits will not be permitted.

- 4.3 At least one refuse bin of adequate size with close fitting lid shall be provided for each building. Refuse bins shall be emptied and cleaned out daily.
- 4.4 Labour shall be employed on camp sanitation duties on the following basis:-
- 4.4.1 Where the number of persons living at the camp is 20 or less - one unit.
- 4.4.2 For additional numbers over 20 living at the camp - one unit per 100 or part thereof.
- 4.5 Unless refuse is removed by a competent authority, it shall be disposed of in pits and covered over daily with a layer of earth or ash of sufficient thickness to prevent depredations by rodents and the breeding of flies.
- 4.6 Adequate measures shall be taken against all vermin and insects responsible for the spread of disease. Any instructions of a competent health authority shall be carried out promptly and implicitly.
- 4.7 Buildings and bedboards shall be treated whenever necessary with an approved insecticide.
- 4.8 The Contractor shall permit and facilitate inspection of the camp and structures on the site by the staff of Transnet or any other competent authority, and shall comply with any reasonable request by such staff or any other competent authority to eliminate any unsanitary condition.
- 4.9 Any outbreak of infectious disease shall immediately be reported telephonically and confirmed in writing to the Technical Officer.
- 4.10 The keeping of animals of any sort is not permitted.
- 4.11 The Contractor shall have on hand at the camp the necessary tools, disinfectants and cleaning materials to maintain and clean the sanitary facilities.
5. **RATIONS**

Rations, where supplied by the Contractor, shall be stored in a suitable and rodent proof building with sufficient shelving.

P02b-06 (JLH)

TRANSNET LIMITED

(Registration no. 1990/000900/06)

**SAFETY ARRANGEMENTS AND PROCEDURAL COMPLIANCE
WITH THE OCCUPATIONAL HEALTH AND SAFETY ACT
(ACT 85 OF 1993) AND APPLICABLE REGULATIONS****1. General**

- 1.1 The Contractor and Transnet Limited (hereinafter referred to as "Transnet") are individual employers, each in its own right, with their respective duties and obligations set out in the Occupational Health and Safety Act, Act 85 of 1993 (the Act) and applicable Regulations.
- 1.2 The Contractor accepts, in terms of the General Conditions of Contract and in terms of the Act, his obligations as an employer in respect of all persons in his employ, other persons on the premises or the Site or place of work or on the work to be executed by him, and under his control. He shall, before commencement with the execution of the contract work, comply with the provisions set out in the Act, and shall implement and maintain a Health and Safety Plan as described in the Construction Regulations, 2003 and as approved by Transnet, on the Site and place of work for the duration of the Contract.
- 1.3 The Contractor accepts his obligation to complying fully with the Act and applicable Regulations notwithstanding the omission of some of the provisions of the Act and the Regulations from this document.
- 1.4 Transnet accepts, in terms of the Act, its obligations as an employer of its own employees working on or associated with the site or place of work, and the Contractor and Technical Officer or his deputy shall at all times, co-operate in respect of the health and safety management of the site, and shall agree on the practical arrangements and procedures to be implemented and maintained during execution of the Works.
- 1.5 In the event of any discrepancies between any legislation and this specification, the applicable legislation will take precedence.

2. Definitions

- 2.1 In this Specification any word or expression to which a meaning has been assigned in the Construction Regulations, shall have the meaning so assigned to it, unless the context otherwise indicates: -
- 2.2 The work included in this Contract shall for the purposes of compliance with the Act be deemed to be "**Construction Work**", which, in terms of the Construction Regulations, 2003 means any work in connection with: -
 - (a) the erection, maintenance, alteration, renovation, repair, demolition or dismantling of or addition to a building or any similar structure;

- (b) the installation, erection, dismantling or maintenance of fixed plant where such work includes the risk of a person falling;
 - (c) the construction, maintenance, demolition or dismantling of any bridge, dam, canal, road, railway, runway, sewer or water reticulation system or any similar civil engineering structure; or
 - (d) the moving of earth, clearing of land, the making of an excavation, piling, or any similar type of work;
- 2.3 **“competent person”** in relation to construction work, means any person having the knowledge, training and experience specific to the work or task being performed: Provided that where appropriate qualifications and training are registered as per the South African Qualifications Authority Act, 1995 these qualifications and training shall be deemed to be the required qualifications and training;
- 2.4 **“contractor”** means principal contractor and “subcontractor” means contractor as defined by the Construction Regulations, 2003.
- 2.5 **“fall protection plan”** means a documented plan, of all risks relating to working from an elevated position, considering the nature of work undertaken, and setting out the procedures and methods applied to eliminate the risk;
- 2.6 **“health and safety file”** means a file, or other record in permanent form, containing the information required to be kept on site in accordance with the Act and applicable Regulations;
- 2.7 **“Health and Safety Plan”** means a documented plan which addresses the hazards identified and include safe work procedures to mitigate, reduce or control the hazards identified;
- 2.8 **“Risk Assessment”** means a programme to determine any risk associated with any hazard at a construction site, in order to identify the steps needed to be taken to remove, reduce or control such hazard;
- 2.9 **“the Act”** means the Occupational Health and Safety Act No. 85 of 1993.

3. Procedural Compliance

- 3.1 The Contractor who intends to carry out any construction work shall, before carrying out such work, notify the Provincial Director in writing if the construction work:-
- (a) includes the demolition of a structure exceeding a height of 3 metres; or
 - (b) includes the use of explosives to perform construction work; or
 - (c) includes the dismantling of fixed plant at a height greater than 3m,
- and shall also notify the Provincial Director in writing when the construction work exceeds 30 days or will involve more than 300 person days of construction work and if the construction work:-
- (a) includes excavation work deeper than 1m; or

- (b) includes working at a height greater than 3 metres above ground or a landing.
- 3.2 The notification to the Provincial Director shall be on a form similar to Annexure A of the Construction Regulations, 2003, also shown in Annexure 1 of this Specification. The Contractor shall ensure that a copy of the completed notification form is kept on site for inspection by an inspector, Technical Officer or employee.
- 3.3 The Contractor shall, in accordance with the Act and applicable Regulations, make all the necessary appointments of competent persons in writing on a form similar to Annexure 2 of this Specification and deliver copies thereof to the Technical Officer. Copies should also be retained on the health and safety file.
- 3.4 Subcontractors shall also make the above written appointments and the Contractor shall deliver copies thereof to the Technical Officer.
- 3.5 In the case of a self-employed Contractor or any subcontractor who has the appropriate competencies and supervises the work himself, the appointment of a construction supervisor in terms of regulation 6.1 of the Construction Regulations, 2003 will not be necessary. The Contractor shall in such a case execute and sign a declaration, as in Annexure 3, by which he personally undertakes the duties and obligations of the "Chief Executive Officer" in terms of section 16(1) of the Act.
- 3.6 The Contractor shall, before commencing any work, obtain from the Technical Officer an access certificate as in Annexure 4 executed and signed by him, permitting and limiting access to the designated site or place of work by the Contractor and any subcontractors under his control.
- 3.7 Procedural compliance with Act and Regulations, as above, shall also apply to any subcontractors as employers in their own right. The Contractor shall furnish the Technical Officer with full particulars of such subcontractors and shall ensure that they comply with the Act and Regulations and Transnet's safety requirements and procedures.

4. Special Permits

Where special permits are required before work may be carried out such as for hotwork, isolation permits, work permits and occupations, the Contractor shall apply to the Technical Officer or the relevant authority for such permits to be issued. The Contractor shall strictly comply with the conditions and requirements pertaining to the issue of such permits.

5. Health and Safety Programme

- 5.1 The Tenderer shall, with his tender, submit a Health and Safety Programme setting out the practical arrangements and procedures to be implemented by him to ensure compliance by him with the Act and Regulations and particularly in respect of: -
- (i) The provision, as far as is reasonably practical, of a working environment that is safe and without risk to the health of his employees and subcontractors in terms of section 8 of the Act;

- (ii) the execution of the contract work in such a manner as to ensure in terms of section 9 of the Act that persons other than those in the Contractor's employment, who may be directly affected by the contract work are not thereby exposed to hazards to their health and safety;
 - (iii) ensuring, as far as is reasonably practical, in terms of section 37 of the Act that no employee or subcontractor of the Contractor does or omits to do any act which would be an offence for the Contractor to do or omit to do.
- 5.2 The Contractor's Health and Safety Programme shall be based on a risk assessment in respect of the hazards to health and safety of his employees and other persons under his control that are associated with or directly affected by the Contractor's activities in performing the contract work and shall establish precautionary measures as are reasonable and practical in protecting the safety and health of such employees and persons.
- 5.3 The Contractor shall cause a risk assessment contemplated in clause 5.2 above to be performed by a competent person, appointed in writing, before commencement of any Construction Work and reviewed during construction. The Risk Assessments shall form part of the Health and Safety programme to be applied on the site and shall include at least the following:
- (a) The identification of the risks and hazards that persons may be exposed to;
 - (b) the analysis and evaluation of the hazards identified;
 - (c) a documented Health and Safety Plan, including safe work procedures to mitigate, reduce or control the risks identified;
 - (d) a monitoring and review plan.
- 5.4 The Health and Safety Plan shall include full particulars in respect of: -
- (a) The safety management structure to be instituted on site or place of work and the names of the Contractor's health and safety representatives and members of safety committees where applicable;
 - (b) the safe working methods and procedures to be implemented to ensure the work is performed in compliance with the Act and Regulations;
 - (c) the safety equipment, devices and clothing to be made available by the Contractor to his employees;
 - (d) the site access control measures pertaining to health and safety to be implemented;
 - (e) the arrangements in respect of communication of health and safety related matters and incidents between the Contractor, his employees, subcontractors and the Technical Officer with particular reference to the reporting of incidents in compliance with Section 24 and General Administrative Regulation 8 of the Act and with the pertinent clause of the General Conditions of Contract forming part of the Contract and

- (f) the introduction of control measures for ensuring that the Safety Plan is maintained and monitored for the duration of the Contract.
- 5.4 The Health and Safety programme shall be subject to the Technical Officer's approval and he may, in consultation with the Contractor, order that additional and/or supplementary practical arrangements and procedures be implemented and maintained by the Contractor or that different working methods or safety equipment be used or safety clothes be issued which, in the Technical Officer's opinion, are necessary to ensure full compliance by the Contractor with his obligations as an employer in terms of the Act and Regulations. The Technical Officer or his deputy shall be allowed to attend meetings of the Contractor's safety committee as an observer.
- 5.5 The Contractor shall take reasonable steps to ensure that each subcontractor's Health and Safety Plan is implemented and maintained on the construction site. Provided that the steps taken, shall include periodic audits at intervals mutually agreed to between them, but at least once every month.
- 5.6 The Contractor shall stop any subcontractor from executing any construction work, which is not in accordance with the Contractor's, and/or subcontractor's Health and Safety Plan for the site or which poses a threat to the health and safety of persons.
- 5.7 The Contractor shall ensure that a copy of the Health and Safety Plan is available on site for inspection by an inspector, Technical Officer, agent, subcontractor, employee, registered employee organisation, health and safety representative or any member of the health and safety committee.
- 5.8 The Contractor shall consult with the health and safety committee or, if no health and safety committee exists, with a representative group of employees, on the development, monitoring and review of the Risk Assessment.
- 5.9 The Contractor shall ensure that all employees under his control are informed, instructed and trained by a competent person regarding any hazard and the related work procedures before any work commences, and thereafter at such times as may be determined in the Risk Assessment.
- 5.10 The Contractor shall ensure that all subcontractors are informed regarding any hazard as stipulated in the Risk Assessment before any work commences, and thereafter at such times as may be determined in the Risk Assessment.
- 5.11 The Contractor shall ensure that all visitors to a construction site undergoes health and safety induction pertaining to the hazards prevalent on the site and shall be provided with the necessary personal protective equipment.

6. Fall Protection Plan

- 6.1 In the event of the risk and hazard identification, as required in terms of clause 5.3 of this Specification, revealing risks relating to working from an elevated position the contractor shall cause the designation of a competent person, responsible for the preparation of a fall protection plan;

- 6.2 The Contractor shall implement, maintain and monitor the fall protection plan for the duration of Contract. The Contractor shall also take such steps to ensure the continued adherence to the fall protection plan.
- 6.3 The fall protection plan shall include:-
- (a) A Risk Assessment of all work carried out from an elevated position;
 - (b) the procedures and methods to address all the identified risks per location;
 - (c) the evaluation of the employees physical and psychological fitness necessary to work at elevated positions;
 - (d) the training of employees working from elevated positions; and
 - (e) the procedure addressing the inspection, testing and maintenance of all fall protection equipment.

7. Hazards and Potential Hazardous Situations

The Contractor and the Technical Officer shall immediately notify one another of any hazardous or potentially hazardous situations which may arise during performance of the Contract by the Contractor or any subcontractor and, in particular, of such hazards as may be caused by the design, execution and/or location and any other aspect pertaining to the contract work.

8. Health and Safety File

- 8.1 The Contractor shall ensure that a health and safety file is opened and kept on site and shall include all documentation required as per the Act and applicable regulations, and made available to an inspector, the Technical Officer, or subcontractor upon request.
- 8.2 The Contractor shall ensure that a copy of the both his Health and Safety Plan as well as any subcontractor's Health and Safety Plan is available on request to an employee, inspector, contractor or the Technical Officer.
- 8.3 The Contractor shall hand over a consolidated health and safety file to the Technical Officer upon completion of the Construction Work and shall in addition to documentation mentioned in the Act and applicable Regulations include a record of all drawings, designs, materials used and other similar information concerning the completed structure.

ANNEXURE 1**OCCUPATIONAL HEALTH AND SAFETY ACT, 1993****Regulation 3(1) of the Construction Regulations****NOTIFICATION OF CONSTRUCTION WORK**

-
-
- 1(a) Name and postal address of principal contractor:

- (b) Name and tel. no of principal contractor's contact person:

2. Principal contractor's compensation registration number: _____
- 3.(a) Name and postal address of client:

- (b) Name and tel no of client's contact person or agent:

- 4.(a) Name and postal address of designer(s) for the project:

- (b) Name and tel. no of designer(s) contact person:

5. Name and telephone number of principal contractor's construction supervisor on site appointed in terms of regulation 6(1).

6. Name/s of principal contractor's construction sub-ordinate supervisors on site appointed in terms of regulation 6(2).

7. Exact physical address of the construction site or site office:

8. Nature of the construction work:

9. Expected commencement date: _____
10. Expected completion date: _____

11. Estimated maximum number of persons on the construction site: _____

12. Planned number of contractors on the construction site accountable to the principle contractor:

13. Name(s) of contractors already chosen.

Principal Contractor

Date

Client

Date

* THIS DOCUMENT IS TO BE FORWARDED TO THE OFFICE OF THE DEPARTMENT OF LABOUR **PRIOR TO COMMENCEMENT** OF WORK ON SITE.

* **ALL PRINCIPAL CONTRACTORS** THAT QUALIFY TO NOTIFY MUST DO SO EVEN IF ANOTHER PRINCIPAL CONTRACTOR ON THE SAME SITE HAD DONE SO PRIOR TO THE COMMENCEMENT OF WORK.

“PREVIEW COPY ONLY”

ANNEXURE 2

(COMPANY LETTER HEAD)

OCCUPATIONAL HEALTH AND SAFETY ACT, 1993 (ACT 85 OF 1993) :

SECTION/REGULATION: _____

REQUIRED COMPETENCY: _____

In terms of _____ I, _____

representing the Employer) do hereby appoint _____

As the Competent Person on the premises at _____

(physical address) to assist in compliance with the Act and the applicable Regulations.

Your designated area/s is/are as follows :-

Date : _____

Signature :- _____

Designation :- _____

ACCEPTANCE OF DESIGNATION

I, _____ do hereby accept this Designation and acknowledge that I understand the requirements of this appointment.

Date : _____

Signature :- _____

Designation :- _____

ANNEXURE 3**(COMPANY LETTER HEAD)****OCCUPATIONAL HEALTH AND SAFETY ACT, 1993 (ACT 85 OF 1993) :****DECLARATION**

In terms of the above Act I, _____ am personally assuming the duties and obligations as Chief Executive Officer, defined in Section 1 of the Act and in terms of Section 16(1), I will, as far as is reasonably practicable, ensure that the duties and obligations of the Employer as contemplated in the above Act are properly discharged.

Signature :- _____

Date : _____

“PREVIEW COPY ONLY”

ANNEXURE 4**(LETTER HEAD OF BUSINESS DIVISION OR UNIT OF TRANSNET LIMITED)****SITE ACCESS CERTIFICATE**

Access to : _____ (Area)
 Name of Contractor/Builder :- _____
 Contract/Order No.: _____

The contract works site/area described above are made available to you for the carrying out of associated works

In terms of your contract/order with
 (company) _____

Kindly note that you are at all times responsible for the control and safety of the Works Site, and for persons under your control having access to the site.

As from the date hereof you will be responsible for compliance with the requirements of the Occupational Health and Safety Act, 1993 (Act 85 of 1993) as amended, and all conditions of the Contract pertaining to the site of the works as defined and demarcated in the contract documents including the plans of the site or work areas forming part thereof.

Signed : _____ Date : _____
TECHNICAL OFFICER

ACKNOWLEDGEMENT OF RECEIPT

*Name of Contractor/Builder :- _____ I,
 _____ do hereby acknowledge and accept the duties
 and obligations in respect of the Safety of the site/area of Work in terms of the Occupational Health and
 Safety Act; Act 85 of 1993.*

Name : _____ Designation : _____

Signature : _____ Date : _____



E7/1 (July 1998)

SPECIFICATION FOR WORKS ON, OVER, UNDER OR ADJACENT TO RAILWAY LINES AND NEAR HIGH VOLTAGE EQUIPMENT

(This Specification shall be used in Transnet Contracts)

“PREVIEW COPY ONLY”

CONTENTS

<u>CLAUSE</u>	<u>DESCRIPTION</u>	<u>PAGE NO'S</u>
1.	<u>DEFINITIONS</u>	3
	<u>PART A - GENERAL SPECIFICATION</u>	
2.	Authority of officers of Transnet	4
3.	Contractor's representatives	4
4.	Occupations and work permits	4
5.	Speed restrictions and protection	5
6.	Roads on Transnet property	5
7.	Clearances	5
8.	Stacking of material	5
9.	Excavation, shoring, dewatering and drainage	5
10.	Falsework for structures	6
11.	Piling	6
12.	Underground services	6
13.	Blasting	6
14.	Rail trolleys	7
15.	Signal track circuits	7
16.	Penalty for delays to trains	7
	<u>PART B - ADDITIONAL SPECIFICATION FOR WORK NEAR HIGH-VOLTAGE ELECTRICAL EQUIPMENT</u>	
17.	General	8
18.	Work on buildings of fixed structures	8
19.	Work done on or outside of rolling stock, including loading and unloading	8
20.	Use of equipment	9
21.	Carrying and handling material and equipment	10
22.	Precautions to be taken when erecting or removing poles, antennae and trees	10
23.	Use of water	10
24.	Use of construction plant	10
25.	Work performed under dead conditions under cover of a work permit	11
26.	Traction return circuits in rails	11
27.	Blasting	11
28.	High-voltage electrical equipment not maintained and/or operated by Transnet	11
	<u>ANNEXURES</u>	
1.	Horizontal clearances 1 065 mm gauge	
2.	Vertical clearances 1 065 mm gauge	
3.	Platform clearances	
4.	Clearances 610 mm gauge	

1 DEFINITIONS

The following definitions shall apply :

Authorised Person. A person whether an employee of Transnet or not, who has been specially authorised to undertake specific duties in terms of Freight Rail's publication SAFETY INSTRUCTIONS: HIGH-VOLTAGE ELECTRICAL EQUIPMENT, and who holds a certificate or letter of authority to that effect.

Barrier. Any device designed to restrict access to "live" high-voltage electrical equipment.

Bond. A short conductor installed to provide electrical continuity.

Contractor. Any person or organisation appointed by Transnet to carry out work on its behalf.

Dead. Isolated and earthed.

Electrical Officer (Contracts). The person appointed in writing by the responsible Electrical Engineer in Transnet as the person who shall be consulted by the Contractor in all electrical matters to ensure that adequate safety precautions are taken by the Contractor.

Executive Officer. The person appointed by Transnet from time to time as the Executive Officer to act according to the rights and powers held by and obligations placed upon him in terms of the Contract.

High-Voltage. A voltage normally exceeding 1 000 volts.

Live. A conductor is said to be "live" when it is at a potential different from that of the earth or any other conductor of the system of which it forms a part.

Near. To be in such a position that a person's body or the tools he is using or any equipment he is handling may come within 3 metres of live exposed high-voltage electrical equipment.

Occupation. An authorisation granted by Transnet for work to be carried out under specified conditions on, over under or adjacent to railway lines.

Occupation Between Trains. An occupation during an interval between successive trains.

Project Manager. The person or juristic person appointed by Transnet from time to time as the Project Manager, to administer the Contract according to the powers and rights held by and obligations placed upon him in terms of the Contract.

Responsible Representative. The responsible person in charge, appointed by a contractor, who has undergone specific training (and holds a certificate) to supervise staff under his control to work on, over, under or adjacent to railway lines and in the vicinity of high-voltage electrical equipment.

Technical Officer. The person or juristic person appointed by Transnet from time to time as the Technical Officer, to administer the Contractor's performance and execution of the Works according to the powers and rights held by and obligations placed upon the Technical Officer in terms of the Contract.

Total Occupation. An occupation for a period when trains are not to traverse the section of line covered by the occupation.

Work on. Work undertaken on or so close to the equipment that the specified working clearances to the live equipment cannot be maintained.

Work Permit. A combined written application and authority to proceed with work on or near dead electrical equipment.

PART A - GENERAL SPECIFICATION**2. AUTHORITY OF OFFICERS OF TRANSNET**

- 2.1 The Contractor shall co-operate with the officers of Transnet and shall comply with all instructions issued and restrictions imposed with respect to the Works which bear on the existence and operation of Transnet's railway lines and high-voltage equipment.
- 2.2 Without limiting the generality of the provisions of 2.1, any duly authorised representative of Transnet, having identified himself, may stop the work if, in his opinion, the safe passage of trains or the safety of Transnet assets or any person is affected. **CONSIDERATIONS OF SAFETY SHALL TAKE PRECEDENCE OVER ALL OTHER CONSIDERATIONS.**

3. CONTRACTOR'S REPRESENTATIVES

- 3.1 The Contractor shall nominate Responsible Representatives of whom at least one shall be available at any hour for call-out in cases of emergency. The Contractor shall provide the Technical Officer with the names, addresses and telephone numbers of the representatives.
- 3.2 The Contractor guarantees that he has satisfied himself that the Responsible Representative is fully conversant with this specification and that he shall comply with all his obligations in respect thereof.

4. OCCUPATIONS AND WORK PERMITS

- 4.1 Work to be done during total occupation or during an occupation between trains or under a work permit shall be done in a manner decided by the Technical Officer and at times to suit Transnet requirements.
- 4.2 The Contractor shall organise the Works in a manner, which will minimise the number and duration of occupations and work permits required.
- 4.3 Transnet will not be liable for any financial or other loss suffered by the Contractor arising from his failure to complete any work scheduled during the period of an occupation or work permit.
- 4.4 The Contractor shall submit to the Technical Officer, in writing, requests for occupations or work permits together with details of the work to be undertaken, at least 14 days before they are required. Transnet does not undertake to grant an occupation or work permit for any particular date, time or duration.
- 4.5 Transnet reserves the right to cancel any occupation or work permit at any time before or during the period of occupation or work permit. If, due to cancellation or change in date or time, the Contractor is not permitted to start work under conditions of total occupation or work permit at the time arranged, all costs caused by the cancellation shall be born by the Contractor except as provided for in clauses 4.6 to 4.8.
- 4.6 When the Contractor is notified less than 2 hours before the scheduled starting time that the occupation or work permit is cancelled, he may claim reimbursement of his direct financial losses caused by the loss of working time up to the time his labour and plant are employed on other work, but not exceeding the period of the cancelled occupation or work permit.
- 4.7 When the Contractor is notified less than 2 hours before the schedule starting time, or during an occupation or work permit, that the duration of the occupation or work permit is reduced, he may claim reimbursement of his direct financial losses caused by the loss of working time due to the reduced duration of the occupation or work permit.
- 4.8 Reimbursement the Contractor for any loss of working time in terms of 4.6 and 4.7, shall be subject to his claims being submitted within 14 days of the event with full details of labour and plant involved, and provided that the Technical Officer certifies that no other work on which the labour and plant could be employed was immediately available.
- 4.9 Before starting any work for which an occupation has been arranged, the Contractor shall obtain from the Technical Officer written confirmation of the date, time and duration of the occupation.

- 4.10 Before starting any work for which a work permit has been arranged, the Responsible Representative shall read and sign portion C of form No. T.1276 signifying that he is aware of the limits within which work may be undertaken. After the work for which the permit was granted has been completed, or when the work permit is due to be terminated, or if the permit is cancelled after the start, the same person who signed portion C shall sign portion D of the T.1276 form, thereby acknowledging that he is aware that the electrical equipment is to be made "live". The Contractor shall advise all his workmen accordingly.

5. **SPEED RESTRICTIONS AND PROTECTION**

- 5.1 When speed restrictions are imposed by Transnet because of the Contractor's activities, the Contractor shall organise and carry out his work so as to permit the removal of the restrictions as soon as possible.
- 5.2 When the Technical Officer considers protection to be necessary the Contractor shall, unless otherwise agreed, provide all protection including flagmen, other personnel and all equipment for the protection of Transnet's and the Contractor's personnel and assets, the public and including trains. Transnet will provide training free of charge of the Contractor's flagmen and other personnel performing protection duties. The Contractor shall consult with the Technical Officer, whenever he considers that protection will be necessary, taking into account the minimum permissible clearances set out in appendixes 1 to 4.
- 5.3 The Contractor shall appoint a Responsible Representative to receive and transmit any instruction, which may be given by Transnet personnel providing protection.

6. **ROADS ON TRANSNET PROPERTY**

The provision of clause 25 of the E.5, General Conditions of Contract, or clause 23 of the E.5 (MW), General Conditions of Contract for Maintenance Works, shall apply to the use of existing roads on Transnet's property.

7. **CLEARANCES**

- 7.1 No temporary works shall encroach on the appropriate minimum clearances set out in Annexure 1 BE97-01 Sheets 1,2, 3 and 5 of 5.

8. **STACKING OF MATERIAL**

- 8.1 The Contractor shall not stack any material closer than 3 m from the centre line of any railway line without prior approval of the Technical Officer.

9. **EXCAVATION, SHORING, DEWATERING AND DRAINAGE**

- 9.1 Unless otherwise approved by the Technical Officer any excavation adjacent to a railway line shall not encroach on the hatched area shown in Figure 1.

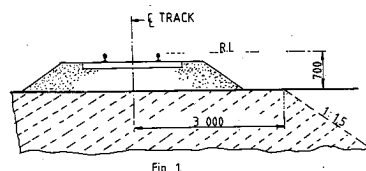

- 9.2 The Contractor shall provide at his own cost any shoring, dewatering or drainage of any excavation unless otherwise stipulated elsewhere in the Contract.
- 9.3 Where required by the Technical Officer, drawings of shoring for any excavation under or adjacent to a railway line shall be submitted and permission to proceed obtained, before the excavation is commenced.

9.4 The Contractor shall prevent ingress of water to the excavation but where water does enter, he shall dispose of it as directed by the Technical Officer.

9.5 The Contractor shall not block, obstruct or damage any existing drains either above or below ground level unless he has made adequate prior arrangements to deal with drainage.

10. **FALSEWORK FOR STRUCTURES**

10.1 Drawings of falsework for the construction of any structure over, under or adjacent to any railway line shall be submitted to the Technical Officer and his permission to proceed obtained before the falsework is erected. Each drawing shall be given a title and a distinguishing number and shall be signed by a registered professional engineer certifying that he has checked the design of the falsework and that the drawings are correct and in accordance with the design.

10.2 After the falsework has been erected and before any load is applied, the Contractor shall submit to the Technical Officer a certificate signed by a registered professional engineer certifying that he has checked the falsework and that it has been erected in accordance with the drawings. Titles and numbers of the drawings shall be stated in the certificate. Notwithstanding permission given by the Technical Officer to proceed, the Contractor shall be entirely responsible for the safety and adequacy of the falsework.

11. **PILING**

11.1 The Technical Officer will specify the conditions under which piles may be installed on Transnet property.

12. **UNDERGROUND SERVICES**

12.1 No pegs or stakes shall be driven or any excavation made before the Contractor has established that there are no underground services, which may be damaged thereby.

12.2 Any damage shall be reported immediately to the Technical Officer, or to the official in charge at the nearest station, or to the traffic controller in the case of centralised traffic control.

13. **BLASTING**

13.1 The provisions of clause 23 of the E.5, General Conditions of Contract or clause 21 of the E.5 (MW), General Conditions of Contract for Maintenance Work, shall apply to all blasting operations undertaken in terms of the Contract.

13.2 The Contractor shall provide proof that he has complied with the provisions of clauses 10.17.1 to 10.17.4 of the Explosives Regulations (Act 26 of 1956 as amended).

13.3 Blasting within 500m of a railway line will only be permitted during intervals between trains. A person appointed by the Technical Officer, assisted by flagmen with the necessary protective equipment, will be in communication with the controlling railway station.

Only this person will be authorised to give the Contractor permission to blast, and the Contractor shall obey his instructions implicitly regarding the time during which blasting may take place.

13.4 The flagmen described in 13.3, where provided by Transnet, are for the protection of trains and Transnet property only, and their presence does not relieve the Contractor in any manner of his responsibilities in terms of Explosives Act or Regulations, or any obligation in terms of this Contract.

- 13.5 The person described in 13.3 will record in a book provided and retained by Transnet the dates and times -
- (i) when each request is made by him to the controlling station for permission to blast;
 - (ii) when blasting may take place;
 - (iii) when blasting actually takes place; and
 - (iv) when he advises the controlling station that the line is safe for the passage of trains.
- 13.6 Before each blast the Contractor shall record in the same book, the details of the blast to be carried out. The person appointed by the Technical Officer and the person who will do the blasting shall both sign the book whenever an entry described in 13.5 is made.
- 13.7 The terms of clause 27 hereof shall be strictly adhered to.
14. **RAIL TROLLEYS**
- 14.1 The use of rail trolleys or trestle trolleys on a railway line for working on high voltage equipment will be permitted only if approved by the Technical Officer and under the conditions stipulated by him.
- 14.2 All costs in connection with such trolley working requested by the Contractor shall, unless otherwise agreed, be borne by the Contractor, excluding the costs of any train protection services normally provided free of charge by Transnet.
15. **SIGNAL TRACK CIRCUITS**
- 15.1 Where signal track circuits are installed, the Contractor shall ensure that no material capable of conducting an electrical current makes contact between rails of a railway line/lines.
- 15.2 No signal connections on track-circuited tracks shall be severed without the Technical Officer's knowledge and consent.
16. **PENALTY FOR DELAYS TO TRAINS**
- 16.1 If any trains are delayed by the Contractor and the Technical Officer is satisfied that the delay was avoidable, a penalty will be imposed on the Contractor of R5 000 per hour or part thereof for the period of delay, irrespective of the number of trains delayed.

PART B - ADDITIONAL SPECIFICATION FOR WORK NEAR HIGH-VOLTAGE ELECTRICAL EQUIPMENT

17. GENERAL

- 17.1 This specification is based on the contents of Freight Rail's publication SAFETY INSTRUCTIONS, HIGH-VOLTAGE ELECTRICAL EQUIPMENT, as amended, a copy of which will be made available on loan to the Contractor for the duration of the contract. These instructions apply to all work near live high-voltage equipment maintained and/or operated by Transnet, and the onus rests on the Contractor to ensure that he obtains a copy.
- 17.2 The Contractor's attention is drawn in particular to the contents of Part I, Sections 1 and 2 of the Safety Instructions : High-Voltage Electrical Equipment.
- 17.3 The Safety Instructions : High-Voltage Electrical Equipment cover the minimum safety precautions which must be taken to ensure safe working on or near high-voltage electrical equipment, and must be observed at all times. Should additional safety measures be considered necessary because of peculiar local conditions, these may be ordered by and at the discretion of the Electrical Officer (Contracts).
- 17.4 This specification must be read in conjunction with and not in lieu of the Safety Instructions : High-Voltage Electrical Equipment.
- 17.5 The Contractor shall obtain the approval of the Electrical Officer (Contracts) before any work is done which causes or could cause any portion of a person's body or the tools he is using or any equipment he is handling, to come within 3 metres of any live high-voltage equipment.
- 17.6 The Contractor shall regard all high-voltage equipment as live unless a work permit is in force.
- 17.7 Safety precautions taken or barriers erected shall comply with the requirements of the Electrical Officer (Contracts), and shall be approved by him before the work to be protected is undertaken by the Contractor. The Contractor shall, unless otherwise agreed, bear the cost of the provision of the barriers and other safety precautions required, including the attendance of Transnet staff where this is necessary.
- 17.8 No barrier shall be removed unless authorised by the Electrical Officer (Contracts).

18. WORK ON BUILDINGS OR FIXED STRUCTURES

Before any work is carried out or measurements are taken on any part of a building, fixed structure or earthworks of any kind above ground level situated within 3 metres of live high-voltage equipment, the Electrical Officer (Contracts) shall be consulted to ascertain the conditions under which the work may be carried out.

- 18.2 No barrier erected to comply with the requirements of the Electrical Officer (Contracts) shall be used as temporary staging or shuttering for any part of the Works.
- 18.3 The shuttering for bridge piers, abutments, retaining walls or parapets adjacent to or over any track may be permitted to serve as a barrier, provided that it extends at least 2,5 metres above any working level in the case of piers, abutments and retaining walls and 1,5 metres above any working level in the case of parapets.

19. WORK DONE ON OR OUTSIDE OF ROLLING STOCK, INCLUDING LOADING OR UNLOADING

- 19.1 No person shall stand, climb or work whilst on any platform, surface or foothold higher than the normal unrestricted places of access, namely -
- (i) the floor level of trucks;
 - (ii) external walkways on diesel, steam and electric locomotives, steam heat vans, etc. and
 - (iii) walkways between coaches and locomotives.
- When in these positions, no person may raise his hands or any equipment or material he is handling

above his head.

- 19.2 In cases where the Contractor operates his own rail mounted equipment, he shall arrange for the walkways on this plant to be inspected by the Electrical Officer (Contracts) and approved, before commencement of work.
- 19.3 The handling of long lengths of material such as metal pipes, reinforcing bars, etc should be avoided, but if essential they shall be handled as nearly as possible in a horizontal position below head height.
- 19.4 The Responsible Representative shall warn all persons under his control of the danger of being near live high-voltage equipment, and shall ensure that the warning is fully understood.
- 19.5 Where the conditions in 19.1 to 19.3 cannot be observed the Electrical Officer (Contracts), shall be notified. He will arrange for suitable Safety measures to be taken. The Electrical Officer (Contracts), may in his discretion and in appropriate circumstances, arrange for a suitable employee of the Contractor to be specially trained by Freight Rail and at its costs, as an Authorised Person to work closer than 3 metres from live overhead conductors and under such conditions as may be imposed by the Senior responsible Electrical Engineer in Transnet.

20. **USE OF EQUIPMENT**

20.1 Measuring Tapes and Devices

- 20.1.1 Measuring tapes may be used near live high-voltage equipment provided that no part of any tape or a person's body comes within 3 metres of the live equipment.
- 20.1.2 In windy conditions the distance shall be increased to ensure that if the tape should fall it will not be blown nearer than 3 metres from the live high-voltage equipment.
- 20.1.3 Special measuring devices longer than 2 metres such as survey staves and rods may be used if these are of non-conducting material and approved by the responsible Electrical Engineer in Transnet, but these devices must not be used within 3 metres of live high-voltage equipment in rainy or wet conditions.
- 20.1.4 The assistance of the Electrical Officer (Contracts) shall be requested when measurements within the limits defined in 20.1.1 to 20.1.3 are required.
- 20.1.5 The restrictions described in 20.1.1 to 20.1.3 do not apply on a bridge deck between permanent parapets nor in other situations where a barrier effectively prevents contact with the live high-voltage equipment.

20.2 Portable Ladders

- 20.2.1 Any type of portable ladder longer than 2 metres may only be used near live high-voltage equipment under the direct supervision of the Responsible Representative. He shall ensure that the ladder is always used in such a manner that the distance from the base of the ladder to any live high-voltage equipment is greater than the fully extended length of the ladder plus 3 metres. Where these conditions cannot be observed, the Electrical Officer (Contracts) shall be advised, and he will arrange for suitable safety measures to be taken.

21. CARRYING AND HANDLING MATERIAL AND EQUIPMENT

- 21.1 Pipes, scaffolding, iron sheets, reinforcing bars and other material, which exceeds 2 metres in length, shall be carried completely below head height near live high-voltage equipment. For maximum safety two or more persons so as to maintain it as nearly as possible in a horizontal position should carry such material. The utmost care must be taken to ensure that no part of the material comes within 3 metres of any live high-voltage equipment.
- 21.2 Long lengths of wire or cable shall never be run out in conditions where a part of a wire or cable can come within 3 metres of any live high-voltage equipment unless the Electrical Officer (Contracts) has been advised and has approved appropriate safety precautions.
- 21.3 The presence of overhead power lines shall always be taken account of especially when communications lines or cables or aerial cables, stay wires, etc. are being erected above ground level.

22. PRECAUTIONS TO BE TAKEN WHEN ERECTING OR REMOVING POLES, ANTENNAE, TREES ETC.

- 22.1 A pole may be handled for the purpose of erection or removal near high-voltage equipment under the following conditions:
- (i) If the distance between the point at which the pole is to be erected or removed and the nearest live high-voltage equipment is more than the length of the pole plus 3 metres, the work shall be supervised by the Responsible Representative.
 - (ii) If the distance described in (i) is less than the length of the pole plus 3 metres, the Electrical Officer (Contracts) shall be consulted to arrange for an Authorised Person to supervise the work and to ensure that the pole is earthed where possible. The pole shall be kept in contact with the point of erection, and adequate precautions shall be taken to prevent contact with live high-voltage equipment.
- 22.2 The cost of supervision by an Authorised Person and the provision of earthing shall, unless otherwise agreed, be borne by the Contractor.
- 22.3 The provisions of clauses 22.1 and 22.2 shall also apply to the erection or removal of columns, antennae, trees, posts, etc.

23. USE OF WATER

- 23.1 No water shall be used in the form of a jet if it can make contact with any live high-voltage equipment or with any person working on such equipment.

24. USE OF CONSTRUCTION PLANT

- 24.1 "Construction plant" entails all types of plant including cranes, piling frames, boring machines, excavators, draglines, dewatering equipment and road vehicles with or without lifting equipment.
- 24.2 When work is being undertaken in such a position that it is possible for construction plant or its load to come within 3 metres of live high-voltage equipment, the Electrical Officer (Contracts) shall be consulted. He will arrange for an Authorised Person to supervise the work and to ensure that the plant is adequately earthed. The Electrical Officer (Contracts) will decide whether further safety measures are necessary.
- 24.3 The cost of any supervision by an Authorised Person and the provision of earthing shall, unless otherwise agreed, be borne by the Contractor.
- 24.4 When loads are handled by cranes, non-metallic rope hand lines shall be used, affixed to such loads so as to prevent their swinging and coming within 3 metres of live high-voltage equipment.
- 24.5 Clauses 24.1 to 24.4 shall apply mutatis mutandis to the use of maintenance machines of any nature.

25. **WORK PERFORMED UNDER DEAD CONDITIONS UNDER COVER OF A WORK PERMIT**

- 25.1 If the Responsible Representative finds that the work cannot be done in safety with the high-voltage electrical equipment live, he shall consult the Electrical Officer (Contracts) who will decide on the action to be taken.
- 25.2 If a work permit is issued the Responsible Representative shall -
- (i) before commencement of work ensure that the limits within which work may be carried out have been explained to him by the Authorised Person who issued the permit to him, and that he fully understands these limits.
 - (ii) sign portion C of the permit before commencement of work;
 - (iii) explain to all persons under his control the limits within which work may be carried out, and ensure that they fully understand these limits;
 - (iv) care for the safety of all persons under his control whilst work is in progress; and
 - (v) withdraw all personnel under his control from the equipment on completion of the work before he signs portion D of the work permit.

26. **TRACTION RETURN CIRCUITS IN RAILS**

- 26.1 DANGEROUS CONDITIONS CAN BE CREATED BY REMOVING OR SEVERING ANY BOND.
- 26.2 Broken rails with an air gap between the ends, and joints, at which fishplates are removed under "broken bond" conditions, are potentially lethal. The rails on either side of an air gap between rail ends on electrified lines shall not be touched simultaneously until rendered safe by Transnet personnel.
- 26.3 The Contractor shall not break any permanent bonds between rails or between rails and any structure. He shall give the Technical Officer at least 7 days written notice when removal of such bonds is necessary.
- 26.4 No work on the track which involves interference with the traction return rail circuit either by cutting or removing the rails, or by removal of bonds shall be done unless the Electrical Officer (Contracts) is consulted. He will take such precautions as may be necessary to ensure continuity of the return circuit before permitting the work to be commenced.

27. **BLASTING**

- 27.1 The Contractor shall obtain the permission of the Electrical Officer (Contracts) before blasting, and shall give at least 14 days notice of his intention to blast.
- 27.2 No blasting shall be done in the vicinity of electrified lines unless a member of Transnet's electrical personnel is present.
- 27.3 The terms of clause 13 hereof shall be strictly adhered to.

28. **HIGH-VOLTAGE ELECTRICAL EQUIPMENT NOT MAINTAINED AND/OR OPERATED BY TRANSNET**

Where the work is undertaken on or near high-voltage electrical equipment which is not maintained and/or operated by Transnet, the Occupational Health and Safety Act No. 85 of 1993, and Regulations and Instructions, or the Mines Health and Safety Act (Act 29 of 1996), shall apply.

Such equipment includes: -

- (i) Eskom and municipal equipment;
- (ii) the Contractor's own power supplies; and
- (iii) electrical equipment being installed but not yet taken over from the Contractor.

ANNEXURE 1
SHEET 1 of 5
AMENDMENT

HORIZONTAL CLEARANCES :
1 065mm TRACK GAUGE

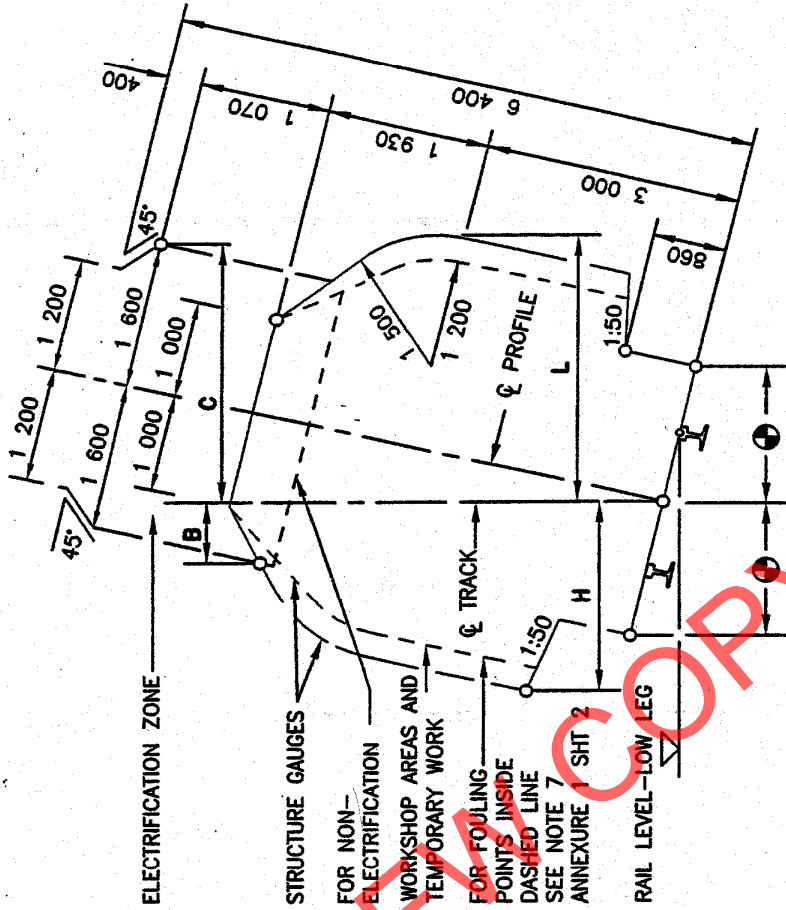

RADIUS (m)	WITH CANT		NO CANT		WITH CANT	
	H (mm)	L (mm)	H & L	C (mm)	B (mm)	C (mm)
90	2 730	3 090	2 780	2 100	1 130	2 100
100	2 700	3 030	2 750	2 050	1 140	2 050
120	2 650	2 970	2 700	2 010	1 160	2 010
140	2 620	2 920	2 660	1 990	1 175	1 990
170	2 590	2 870	2 630	1 970	1 190	1 970
200	2 570	2 820	2 600	1 950	1 205	1 950
250	2 550	2 790	2 580	1 930	1 230	1 930
300	2 540	2 760	2 560	1 900	1 250	1 900
350	2 530	2 730	2 540	1 890	1 270	1 890
400	2 520	2 710	2 530	1 875	1 290	1 875
500	2 510	2 680	2 520	1 850	1 320	1 850
600	2 500	2 660	2 510	1 830	1 340	1 830
800	2 490	2 620	2 500	1 790	1 365	1 790
1 000	2 480	2 600	2 490	1 760	1 380	1 760
1 200	2 480	2 580	2 490	1 730	1 200	1 730
1 500	2 480	2 550	2 480	1 700	1 415	1 700
2 000	2 480	2 500	2 480	1 660	1 440	1 660
3 000	2 470	2 470	2 470	1 600	1 500	1 600
>5 000	2 460	2 460	2 460	1 600	1 600	1 600

REMARKS:

1. H AND B IS THE REQUIRED HORIZONTAL CLEARANCE ON THE OUTSIDE OF THE CURVE BASED ON MINIMUM CANT.
2. L AND C IS THE REQUIRED HORIZONTAL CLEARANCE ON THE INSIDE OF THE CURVE BASED ON MAXIMUM CANT.
3. INTERMEDIATE VALUES MAY BE INTERPOLATED BY THE ENGINEER IN CHARGE.
4. FOR WORKSHOP AREAS AND TEMPORARY WORK, CLEARANCES H AND L MAY BE REDUCED BY 300mm.
5. SEE ANNEXURE 1 SHEET 3 FOR PLATFORM CLEARANCES.
6. ALSO REFER TO REMARKS 4 TO 8 OF ANNEXURE 1 SHEET 2.

ANNEXURE 1
SHEET 2 of 5
AMENDMENT

VERTICAL CLEARANCES :
1 065mm TRACK GAUGE

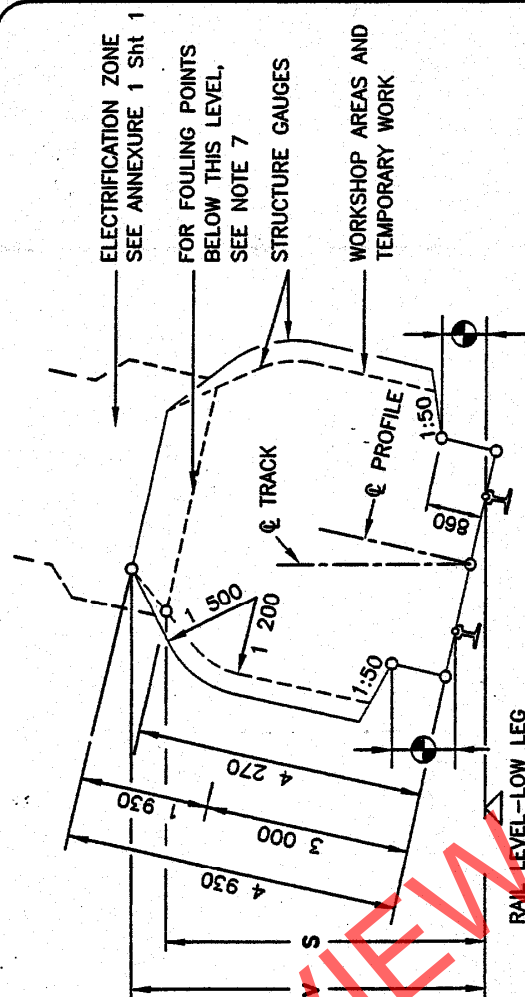

LOCATION	ELECTRIFIED (PRESENT OR FUTURE)		NOT ELECTRIFIED
	3kV & 25kV	50kV	
RADIUS (mm)	V (mm)	V (mm)	S (mm)
100	5 050	5 400	4 470
300	5 020	5 370	4 410
600	5 000	5 350	4 370
1 000	4 990	5 340	4 350
1 500	4 960	5 310	4 310
2 000	4 940	5 290	4 290
>3 000	4 930	5 280	4 270
* OVER OR NEAR POINTS AND CROSSING IF REQUIRED BY ELECTRICAL IRRESPECTIVE OF RADIUS	5 650	6 000	

ALL AREAS OTHER THAN * BELOW THOSE INDICATED BY

- REMARKS:**
1. V IS THE REQUIRED VERTICAL CLEARANCE EXCEPT WHERE REDUCED CLEARANCE S APPLIES.
 2. S IS THE MINIMUM VERTICAL CLEARANCE FOR STRUCTURES AND TEMPORARY WORK OVER NON-ELECTRIFIED LINES.
 3. INTERMEDIATE VALUES MAY BE INTERPOLATED BY THE ENGINEER IN CHARGE.
 4. FOR APPLICATION AT CURVES
 - 4.1 APPLY INCREASED CLEARANCES FOR CURVES TO POINTS 3m BEYOND THE ENDS OF THE CIRCULAR CURVE.
 - 4.2 REDUCE CLEARANCES AT A UNIFORM RATE OVER THE REMAINDER OF THE TRANSITION CURVE.
 - 4.3 FOR NON-TRANSITIONED CURVES REDUCE AT A UNIFORM RATE OVER A LENGTH OF 15m ALONG STRAIGHTS.
 5. NEW STRUCTURES: SEE BRIDGE CODE.
 6. TUNNELS: SEE DRAWING BE 82-35.
 7. FOULING POINTS: SEE CLAUSE 8.1.
 8. CLEARANCES ARE BASED ON 15m BOGIE CENTRES AND 21,2m VEHICLE BODY LENGTH.
 9. SEE ANNEXURE 1 SHEET 3 FOR PLATFORM CLEARANCES.

ANNEXURE 1
SHEET 3 of 5
AMENDMENT

CLEARANCES : PLATFORMS

PLATFORMS : TRACK GAUGE 1 065mm

PASSENGERS

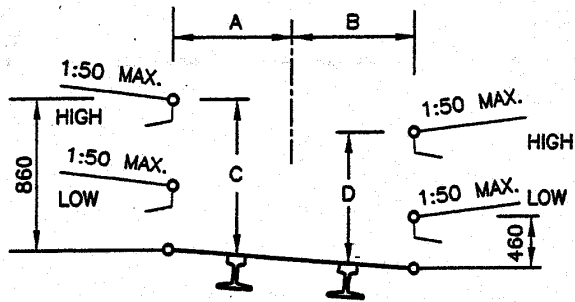

GOODS

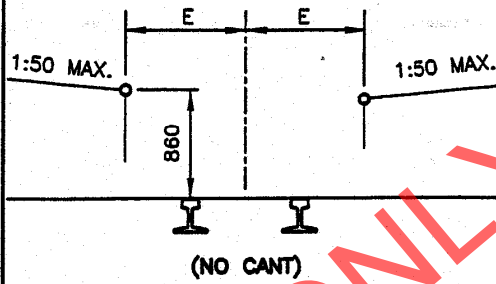

RADIUS (m)	A (mm)	B (mm)	C (mm)	D (mm)	E (mm)
90	1 690	1 820	890	810	1 840
100	1 650	1 790	890	810	1 810
120	1 610	1 740	890	810	1 760
140	1 580	1 700	890	810	1 720
170	1 550	1 660	890	810	1 690
200	1 530	1 630	890	820	1 670
250	1 520	1 600	890	820	1 640
300	1 520	1 580	890	830	1 620
350	1 520	1 560	880	830	1 600
400	1 520	1 550	880	840	1 590
500	1 520	1 540	880	850	1 580
600	1 520	1 530	870	850	1 570
800	1 520	1 520	860	860	1 560
1 200	1 520	1 520	860	860	1 550
2 000	1 520	1 520	860	860	1 540
3 000	1 520	1 520	860	860	1 530
STRAIGHT	1 520	1 520	860	860	1 520

REMARKS:

1. NO CANT TO BE APPLIED EXCEPT WHEN THE GOODS PLATFORM IS ON A RUNNING LINE.
2. INTERMEDIATE VALUES MAY BE INTERPOLATED BY THE ENGINEER IN CHARGE.
3. 8m TO MAIN STATION-BUILDINGS AND 3m TO ALL OTHER STRUCTURES.
4. TOLERANCES : SEE CLAUSE 8.0.10.

STRUCTURES ON PLATFORMS : 1 065mm AND 610mm TRACK GAUGE

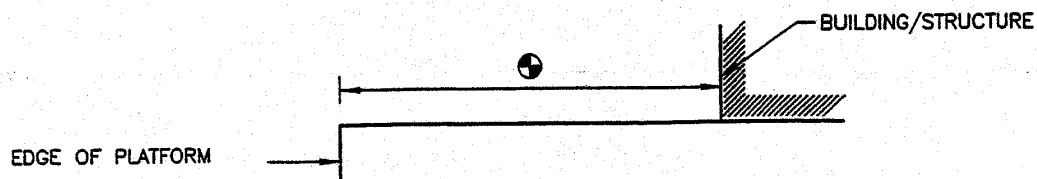

ANNEXURE 1
SHEET 5 of 5
AMENDMENT

CLEARANCES : 610mm TRACK GAUGE

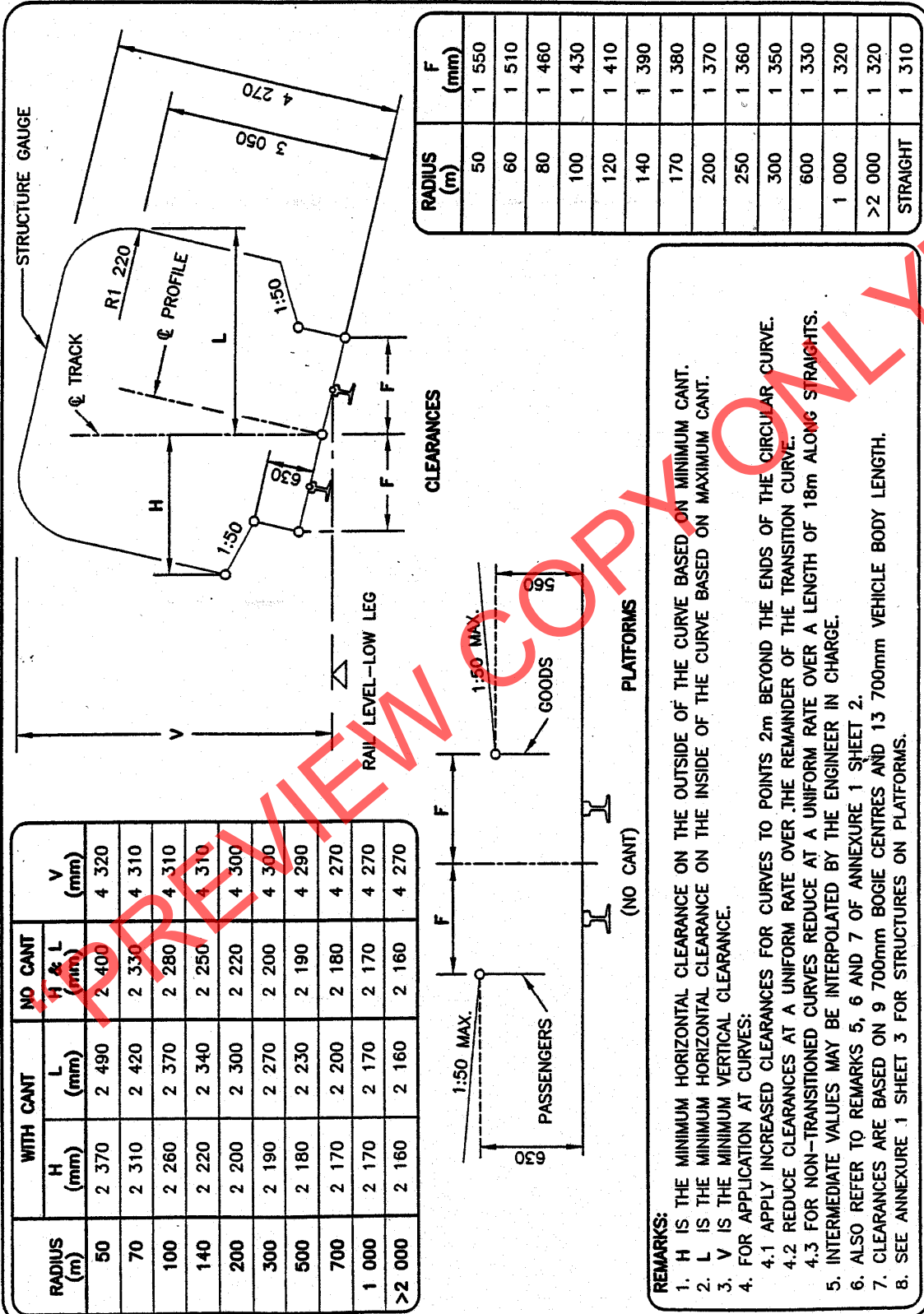

REMARKS:

- H IS THE MINIMUM HORIZONTAL CLEARANCE ON THE OUTSIDE OF THE CURVE BASED ON MINIMUM CANT.
- L IS THE MINIMUM HORIZONTAL CLEARANCE ON THE INSIDE OF THE CURVE BASED ON MAXIMUM CANT.
- V IS THE MINIMUM VERTICAL CLEARANCE.
- FOR APPLICATION AT CURVES:
 - APPLY INCREASED CLEARANCES FOR CURVES TO POINTS 2m BEYOND THE ENDS OF THE CIRCULAR CURVE.
 - REDUCE CLEARANCES AT A UNIFORM RATE OVER THE REMAINDER OF THE TRANSITION CURVE.
 - FOR NON-TRANSITIONED CURVES REDUCE AT A UNIFORM RATE OVER A LENGTH OF 18m ALONG STRAIGHTS.
- INTERMEDIATE VALUES MAY BE INTERPOLATED BY THE ENGINEER IN CHARGE.
- ALSO REFER TO REMARKS 5, 6 AND 7 OF ANNEXURE 1 SHEET 2.
- CLEARANCES ARE BASED ON 9 700mm BOGIE CENTRES AND 13 700mm VEHICLE BODY LENGTH.
- SEE ANNEXURE 1 SHEET 3 FOR STRUCTURES ON PLATFORMS.



NON-DISCLOSURE AGREEMENT

THIS AGREEMENT is made at on the day of 2010

BETWEEN:

Transnet Limited ("Transnet") (Registration No. 1990/000900/06)

whose registered office is at 49th Floor, Carlton Centre, 150 Commissioner Street,
Johannesburg 2001, Gauteng, Republic of South Africa

and

whose registered office is at _____

WHEREAS

Transnet and the Company wish to exchange Information (as defined below) and it is envisaged that each party may from time to time receive Information relating to the other in respect thereof. In consideration of each party making available to the other such Information, the parties jointly agree that any dealings between them shall be subject to the terms and conditions of this Agreement which themselves will be subject to the parameters of the Proposal.

IT IS HEREBY AGREED

1. Interpretation

In this Agreement:-

"**Agents**" means directors, officers, employees, agents, professional advisers, contractors or sub-contractors, or any Group member;

“Confidential Information” means any information or other data relating to one party (the “Disclosing Party”) and/or the business carried on or proposed or intended to be carried on by that party and which is made available for the purposes of the Proposal to the other party (the “Receiving Party”) or its Agents by the Disclosing Party or its Agents or recorded in agreed minutes following oral disclosure and any other information otherwise made available by the Disclosing Party or its Agents to the Receiving Party or its Agents, whether before, on or after the date of this Agreement, and whether in writing or otherwise, including any information, analysis or specifications derived from, containing or reflecting such information but excluding information which:-

- (a) is publicly available at the time of its disclosure or becomes publicly available (other than as a result of disclosure by the Receiving Party or any of its Agents contrary to the terms of this Agreement); or
- (b) was lawfully in the possession of the Receiving Party or its Agents (as can be demonstrated by its written records or other reasonable evidence) free of any restriction as to its use or disclosure prior to its being so disclosed; or
- (c) following such disclosure, becomes available to the Receiving Party or its Agents (as can be demonstrated by its written records or other reasonable evidence) from a source other than the Disclosing Party or its Agents, which source is not bound by any duty of confidentiality owed, directly or indirectly, to the Disclosing Party in relation to such information;

“Group” means any subsidiary, any holding company and any subsidiary of any holding company of either party;

“Information” means all information in whatever form including, without limitation, any information relating to systems, operations, plans, intentions, market opportunities, know-how, trade secrets and business affairs whether in writing, conveyed orally or by machine-readable medium; and

“Proposal” means the aggregation of Transnet’s Request for Information (RFI) and Request for Proposal (RFP).

2. Confidential Information

- 2.1 The Receiving Party will treat and keep all Confidential Information as secret and confidential and will not, without the Disclosing Party’s written consent, directly or indirectly communicate or disclose (whether in writing or orally or in any other manner) Confidential Information to any other person other than in accordance with the terms of this Agreement.
- 2.2 The Receiving Party will only use the Confidential Information for the sole purpose of technical and commercial discussions between the parties in relation to the

Proposal or for the subsequent performance of any contract between the parties in relation to the Proposal.

2.3 Notwithstanding clause 2.1, the Receiving Party may disclose Confidential Information:

- (a) To those of its Agents who strictly need to know the Confidential Information for the sole purpose set out in clause 2.2 provided that the Receiving Party shall ensure that such Agents are made aware prior to the disclosure of any part of the Confidential Information that the same is confidential and that they owe a duty of confidence to the Disclosing Party. The Receiving Party shall at all times remain liable for any actions of such Agents that would constitute a breach of this Agreement; or
- (b) to the extent required by law or the rules of any applicable regulatory authority, subject to clause 2.4 below.

2.4 In the event that the Receiving Party is required to disclose any Confidential Information in accordance with clause 2.3 (ii) above, it shall promptly notify the Disclosing Party and co-operate with the Disclosing Party regarding the form, nature, content and purpose of such disclosure or any action which the Disclosing Party may reasonably take to challenge the validity of such requirement.

2.5 In the event that any Confidential Information shall be copied, disclosed or used otherwise than as permitted under this Agreement then, upon becoming aware of the same, without prejudice to any rights or remedies of the Disclosing Party, the Receiving Party shall as soon as practicable notify the Disclosing Party of such event and if requested take such steps (including the institution of legal proceedings) as shall be necessary to remedy (if capable of remedy) the default and/or to prevent further unauthorised copying, disclosure or use.

2.6 All Confidential Information shall remain the property of the Disclosing Party and its disclosure shall not confer on the Receiving Party any rights, including intellectual property rights, over the Confidential Information whatsoever beyond those contained in this Agreement.

3. Records and return of Information

3.1 The Receiving Party agrees to ensure proper and secure storage of all Information and any copies thereof to at least the same standard as the Receiving Party keeps its own Confidential Information. The Receiving Party shall not make any copies or reproduce in any form any Confidential Information except for the purpose of disclosure as permitted in accordance with this Agreement.

3.2 The Receiving Party shall keep a written record, to be supplied to the Disclosing Party upon request, of the Confidential Information provided and any copies made

thereof and, so far as is reasonably practicable, of the location of such Confidential Information and any copies thereof.

3.3 The Receiving Party shall, within seven days of receipt of a written demand from the Disclosing Party or of its ceasing to be interested in the Proposal:

- (a) Return all written Confidential Information (including all copies); and
- (b) expunge or destroy any Confidential Information from any computer, word processor or other device whatsoever into which it was copied, read or programmed by the Receiving Party or on its behalf (including by any person

The obligations in this clause 3.3 shall not apply to the extent that (but only for so long as) it is necessary to retain copies for the purpose of providing information to any regulatory authority in accordance with clause 2.3 (b) above.

3.4 The Receiving Party shall on request supply a certificate signed by a director as to its full compliance with the requirements of clause 3.3 (b) above.

4. Announcements

4.1 Neither party will make or permit to be made any announcement or disclosure of its prospective interest in the Proposal without the prior written consent of the other party.

4.2 Neither party shall make use of the other party's name or any information acquired through its dealings with the other party for publicity or marketing purposes without the prior written consent of the other party.

5. Duration

The obligations of each party and its Agents under this Agreement shall survive the termination of any discussions or negotiations between the parties regarding the Proposal and continue thereafter for a period of 5 (five) years.

6. Principal

Each party confirms that it is acting as principal and not as nominee, agent or broker for any other person and that it will be responsible for any costs incurred by it or its advisers in considering or pursuing the Proposal and in complying with the terms of this Agreement.

7. Adequacy of damages

Nothing contained in this Agreement shall be construed as prohibiting the Disclosing Party from pursuing any other remedies available by it, either at law or in equity, for any such threatened or actual breach of this Agreement including specific performance, recovery of damages or otherwise.

8. Privacy and Data Protection

- 8.1 The Receiving Party undertakes to comply with South Africa's general privacy protection in terms of the Bill of Rights (Section 14) in connection with this Proposal and shall procure that its personnel shall observe the provisions of such Act (as applicable) or any amendments and re-enactments thereof and any regulations made pursuant thereto.
- 8.2 The Receiving Party warrants that it and its Agents have the appropriate technical and organisational measures in place against unauthorised or unlawful processing of data relating to the Proposal and against accidental loss or destruction of, or damage to such data held or processed by them.

9. General

- 9.1 Neither party may assign the benefit of this Agreement or any interest hereunder except with the prior written consent of the other, save that Transnet may assign this Agreement at any time to any member of the Transnet Group.
- 9.2 No failure or delay in exercising any right, power or privilege under this Agreement will operate as a waiver of it, nor will any single or partial exercise of it preclude any further exercise or the exercise of any right, power or privilege under this Agreement or otherwise.
- 9.3 The provisions of this Agreement shall be severable in the event that any of its provisions are held by a court of competent jurisdiction or other applicable authority to be invalid, void or otherwise unenforceable, and the remaining provisions shall remain enforceable to the fullest extent permitted by law.
- 9.4 This Agreement may only be modified by a written agreement duly signed by persons authorised on behalf of each party.
- 9.5 Nothing in this Agreement shall constitute the creation of a partnership, joint venture or agency between the parties.
- 9.6 This Agreement will be governed by and construed in accordance with South African law and the parties irrevocably submit to the exclusive jurisdiction of the South African courts.

IN WITNESS WHEREOF, the parties hereto have caused this Agreement to be executed by their respective duly authorised representatives.

For and on behalf of TRANSNET LIMITED duly authorised thereto	For and on behalf of _____ duly authorised thereto
Name:	Name:
Position:	Position:
Signature:	Signature:
Date:	Date:

AS WITNESS: Name:	AS WITNESS: Name:
Signature:	Signature:
Date:	Date:

AS WITNESS: Name:	AS WITNESS: Name:
Signature:	Signature:
Date:	Date:

“PREVIEW COPY ONLY”



Transnet Supplier Declaration/Application

The Financial Director or Company Secretary

Transnet Vendor Management has received a request to load your company on to the Transnet vendor database. Please furnish us with the following to enable us to process this request:

1. Complete the "Supplier Declaration Form" (SDF) on page 2 of this letter
2. **Original** cancelled cheque **OR** letter from the bank verifying banking details (**with bank stamp**)
3. **Certified** copy of Identity document of Shareholders/Directors/Members (where applicable)
4. **Certified** copy of certificate of incorporation, CM29 / CM9 (name change)
5. **Certified** copy of share Certificates of Shareholders, CK1 / CK2 (if CC)
6. A letter with the company's letterhead confirming physical and postal addresses
7. **Original or certified** copy of SARS Tax Clearance certificate and Vat registration certificate
8. A signed letter from the Auditor / Accountant confirming most recent annual turnover and percentage black ownership in the company **AND/OR** BBBEE certificate and detailed scorecard from an accredited rating agency (SANAS member).

NB: *• Failure to submit the above documentation will delay the vendor creation process.
• Where applicable, the respective Transnet business unit processing your application may request further information from you. E.g. proof of an existence of a Service/Business contract between your business and the respective Transnet business unit etc.*

IMPORTANT NOTES:

- a) **If your annual turnover is less than R5 million**, then in terms of the DTI codes, you are classified as an Exempted Micro Enterprise (EME). If your company is classified as an EME, please include in your submission, a signed letter from your Auditor / Accountant confirming your company's most recent annual turnover is less than R5 million and percentage of black ownership and black female ownership in the company AND/OR BBBEE certificate and detailed scorecard from an accredited rating agency (e.g. permanent SANAS Member), should you feel you will be able to attain a better BBBEE score.
- b) **If your annual turnover is between R5 million and R35million**, then in terms of the DTI codes, you are classified as a Qualifying Small Enterprise (QSE) and you claim a specific BBBEE level based on any 4 of the 7 elements of the BBBEE score-card, please include your BEE certificate in your submission as confirmation of your status.
NB: BBBEE certificate and detailed scorecard should be obtained from an accredited rating agency (e.g. permanent SANAS Member).
- c) **If your annual turnover is in excess of R35million**, then in terms of the DTI codes, you are classified as a Large Enterprise and you claim a specific BEE level based on all seven elements of the BBBEE generic score-card. Please include your BEE certificate in your submission as confirmation of your status.
NB: BBBEE certificate and detailed scorecard should be obtained from an accredited rating agency (permanent SANAS Member).
- d) **To avoid PAYE tax being automatically deducted from any invoices received from you**, you must also contact the Transnet person who lodged this request on your behalf, so as to be correctly classified in terms of Tax legislation.
- e) Unfortunately, **No payments can be made to a vendor** until the vendor has been registered, and no vendor can be registered until the vendor application form, together with its supporting documentation, has been received and processed.
- f) **Please return the completed Supplier Declaration Form (SDF) together with the required supporting documents mentioned above to the Transnet Official who is intending to procure your company's services/products in order that he/she should complete and Internal Transnet Departmental Questionnaire before referring the matter to the appropriate Transnet Vendor Master Office.**

Regards,

Transnet Vendor/Supplier Management *[please substitute this with your relevant Transnet department before sending this document out]*



Supplier Declaration Form

Company Trading Name							
Company Registered Name							
Company Registration Number Or ID Number If A Sole Proprietor							
Form of entity	CC	Trust	Pty Ltd	Limited	Partnership	Sole Proprietor	
VAT number (if registered)							
Company Telephone Number							
Company Fax Number							
Company E-Mail Address							
Company Website Address							
Bank Name				Bank Account Number			
Postal Address						Code	
Physical Address						Code	
Contact Person							
Designation							
Telephone							
Email							
Annual Turnover Range (Last Financial Year)	< R5 Million	R5-35 million		> R35 million			
Does Your Company Provide	Products	Services		Both			
Area Of Delivery	National	Provincial		Local			
Is Your Company A Public Or Private Entity		Public		Private			
Does Your Company Have A Tax Directive Or IRP30 Certificate		Yes		No			
Main Product Or Service Supplied (E.G.: Stationery/Consulting)							
BEE Ownership Details							
% Black Ownership		% Black women ownership		% Disabled person/s ownership			
Does your company have a BEE certificate		Yes		No			
What is your broad based BEE status (Level 1 to 9 / Unknown)							
How many personnel does the firm employ		Permanent		Part time			
Transnet Contact Person							
Contact number							
Transnet operating division							
Duly Authorised To Sign For And On Behalf Of Firm / Organisation							
Name				Designation			
Signature				Date			
Stamp And Signature Of Commissioner Of Oath							
Name				Date			
Signature				Telephone No.			

NB: Please return the completed Supplier Declaration Form (SDF) together with the required supporting documents mentioned above to the Transnet Official who is intending to procure your company's services/products.



2. VENDOR TYPE OF BUSINESS

(Please tick as applicable)

(* - Minimum requirements)

2.1 Indicate the business sector in which your company is involved/operating:

Agriculture		Mining and Quarrying	
Manufacturing		Construction	
Electricity, Gas and Water		Finance and Business Services	
Retail, Motor Trade and Repair Services		Wholesale Trade, Commercial Agents and Allied Services	
Catering, accommodation and Other Trade		Transport, Storage and Communications	
Community, Social and Personal Services		Other (Specify)	
Principal Business Activity *			
Types of Services Provided			
Since when has the firm been in business?			

2.2 What is your company's annual turnover (excluding VAT)? *

<R20k	>R20k <R0.3m	>R0.3m <R1m	>R1m <R5m	>R6m <R10m	>R11m <R15m	>R16m <R25m	>R26m <R30m	>R31m <R34m	>R35m

2.3 Where are your operating/distribution centres situated *

3. VENDOR OWNERSHIP DETAIL

(Please tick as applicable)

(* - Minimum requirements)

3.1 Did the firm previously operate under another name? *

YES		NO	
-----	--	----	--

3.2 If Yes state its previous name:*

Registered Name	
Trading Name	



3.3	Who were its previous owners / partners / directors?*	
SURNAME & INITIALS		ID NUMBERS

3.4	List Details of current partners, proprietors and shareholders by name, identity number, citizenship, status and ownership as relevant: *							
SURNAME & INITIALS	IDENTITY NUMBER	CITI-ZENSHIP	HDI	DIS-ABLED	GENDER	DATE OF OWNERSHIP	% OWNED	% VOTING

3.5	List details of current directors, officers, chairman, secretary etc. of the firm: *					
SURNAME & INITIALS	IDENTITY NUMBER	TITLE	DIS-ABLED	GENDER	% OF TIME DEVOTED TO THE FIRM	CONTACT NUMBER

3.6	List details of firms personnel who have an ownership interest in another firm: *				
SURNAME & INITIALS	IDENTITY NUMBER	NAME & ADDRESS OF OTHER FIRM	TITLE IN OTHER FIRM	% OWNED	TYPE OF BUSINESS OF OTHER FIRM

4. VENDOR DETAIL

(Please tick as applicable) (* - Minimum requirements)

4.1	How many personnel does the firm employ? *					
	BLACK	WHITE	COLOURED	INDIAN	OTHER	TOTAL
Permanent						
Part Time						



4.1.1 In terms of above kindly provide numbers on women and disabled personnel? *

	BLACK	WHITE	COLOURED	INDIAN	OTHER	TOTAL
Women						
Disabled						

4.2 Provide Details of Contact Person/s Responsible for Broad Based Black Economic Empowerment (BBBEE) in the Company *

SURNAME	INITIALS	DESIGNATION	TELEPHONE NO.

4.2.1 Is your company a value adding supplier (i.e. registered as a vendor under the VAT Act of 1991, where NPAT + total labour cost > 25% of total revenue)?

YES		NO	
-----	--	----	--

4.2.2 Is your company a recipient of Enterprise Development Contributions?*

YES		NO	
-----	--	----	--

4.2.3 May the above mentioned information be shared and included in Transnet Supplier Database for future reference? *

YES		NO	
-----	--	----	--

4.2.4 If you are successful in the tender/contract (where applicable) and this is awarded to your company / organisation, will this have a positive impact on your employment plans? *

YES		NO	
-----	--	----	--

4.2.5 If yes (above) kindly provide the following information:

	BLACK	WHITE	COLOURED	INDIAN	OTHER	TOTAL
Permanent						
Part Time						

4.2.6 In terms of above kindly provide numbers on woman and disabled personnel:

	BLACK	WHITE	COLOURED	INDIAN	OTHER	TOTAL
Women						
Disabled						

4.2.7 Are any of your members/shareholders/directors ex employees of Transnet?

YES		NO	
-----	--	----	--

4.2.8 Are any of your family members employees of Transnet?

YES		NO	
-----	--	----	--

4.2.9 If Yes to points 4.2.7 & 4.2.8, list details of employees/ex-employees

SURNAME & INITIALS	IDENTITY NUMBER	NAME & ADDRESS OF OTHER FIRM	TITLE IN OTHER FIRM	% OWNED	TYPE OF BUSINESS OF OTHER FIRM



Internal Transnet Departmental Questionnaire (for office use only)

Section 1: To be completed by the Transnet Requesting / Sourcing Department

TFR		TRE		TPT		TPL		TNPA		TRN	
Create		Amend		Block		Unblock		Once-Off / Emergency			
Extend		Delete		Undele							

Supplier's trading name											
Supplier's registered name											
Please indicate if the Supplier has a contract with sourcing Transnet OD								Yes		No	
If yes please submit a copy of the letter of award											

a) What is being procured from the supplier?

i. Products only	Yes		No	
ii. Services only	Yes		No	
iii. Labour only	Yes		No	
iv. Mix of services and products	Yes		No	
v. Mix of services and labour	Yes		No	

b) If your answer is YES to questions II, III, IV or V in paragraph a) above, please indicate whether the relevant PAYE questionnaires have been forwarded to the appropriate Transnet Operational Divisions' decision making bodies / Strategic Supply Management team for a directive /decision on tax withholding from payments to this supplier.

Yes		No	
-----	--	----	--

c) If your reply to (b) is "NO", please furnish reasons :

d) Certification and Approval of proposed Vendor Creation/Unblocking/Other Changes by Transnet Official with Appropriate Delegated Authority :

I HEREBY CERTIFY THAT THE TRANSNET DETAILED PROCUREMENT PROCESS (DPP) / PROCUREMENT MECHANISM HAS IN ALL RESPECTS BEEN ADHERED TO AND I THEREFORE APPROVE THE PROPOSED VENDOR CREATION/APPROVAL/OTHER CHANGES TO BE EFFECTED ON THE VENDOR MASTER

Name	Grade	Date								Signature
		Y	Y	Y	Y	M	M	D	D	

Tel No:		Fax	
----------------	--	------------	--

Section 2: To be completed by the BEE Department (this section is for Confirmation/Determining of BEE Status)

NARROW BASED (NB)				BROADBASED (BBBEE)								
BEE O/S	BWBE	DPBE	MR	CONTB. LEVEL	EME: <R5m	QSE: >R5m <R35m	LARGE: >R35m	VALIDITY DATE				
Name		Grade		Date				Signature				
				Y	Y	Y	Y	M	M	D	D	
				Y	Y	Y	Y	M	M	D	D	

TRANSNET LIMITED / CONTRACTORS / SUB-CONTRACTORS

CONTRACTUAL SAFETY CLAUSES WHICH WILL FORM PART OF ANY RESULTING CONTRACT

The parties agree on the following arrangements according to section 37 (2) of the Occupational Health and Safety Act, 1993 (Act 85 of 1993) to ensure compliance by the mandatory with provisions of the Act.

- 1) That the contractor is an “employer” in his own right as defined in section 1 of Act 85 of 1993 and that he must fulfill all his obligations as an employer in terms of the Act.
- 2) The contractor shall comply with the requirements of Act 85 of 1993 in its entirety.
- 3) Where special permits are required, such as electrical switching, hot work permits, etc. the contractor shall obtain them from a person designated by Transnet Limited for this purpose, and all requirements of the contractor must rigidly comply with the permit.
- 4) The contractor shall conduct a risk assessment of the work to be performed by a competent person prior to the commencement of work, to identify risks and hazards that persons may be exposed to, analyse and evaluate identified hazards.
- 5) The contractor shall have a documented Health and Safety Plan based on the risks and hazards identified before commencement of work.
- 6) The Health and Safety Plan shall include the following:
 - 6.1 The safety management structure to be instituted with all appointments in terms of the Act and Regulations
 - 6.2 The safe working methods and procedures to be implemented to ensure work is performed in compliance to the Act.
 - 6.3 The safety equipment, devices and clothing to be made available by the contractor to his employees.
 - 6.4 The site access control measures pertaining to health and safety to be implemented.
 - 6.5 Control measures for ensuring that the Health and Safety Plan is maintained and monitored for the duration of the contract.
- 7) The contractor shall ensure that all work is performed under the close supervision of a person trained to understand the hazards associated with the work performed and who has authority to ensure that the necessary precautionary measures are implemented.
- 8) The contractor must appoint a Health and Safety Co-ordinator to liaise with Transnet Limited on matters pertaining to occupational health and safety.
- 9) The appointed Safety Co-ordinator must liaise at least once a week with the* Health and Safety Section / Risk Manager /Occupational Risk Manager of Transnet Limited.
- 10) The contractor shall furnish the* Health and Safety Section/ Risk Manager/ Occupational Risk Manager of Transnet Limited immediately with full particulars of any sub-contractor which he may involve in the contract in order that the sub-contractor himself can be made aware of all the clauses in this contract pertaining to health and safety.
- 11) The contractor shall stop any subcontractor from executing work which is not in accordance with the Health and Safety Plan or which poses a threat to health and safety of persons.

- 12) The contractor shall ensure that all his employees and visitors undergoes health and safety induction pertaining to the hazards prevalent, proof of such training must be kept on file.
- 13) In the event where the risk assessment reveals the risk relating to working from an elevated position the contractor shall cause the designation of a competent person, responsible for the preparation of a Fall Protection Plan.
- 14) The Fall Protection Plan shall include:
 - 14.1 A risk assessment of all work carried out from an elevated position
 - 14.2 Procedures and methods to address all the identified risks per location
 - 14.3 Evaluation of employees physical and psychological fitness necessary to work at elevated position.
 - 14.4 The training of employees working from an elevated position.
 - 14.5 Procedure addressing the inspection, testing and maintenance of all fall protection equipment.
- 15) The contractor shall advise the * Health and Safety Section / Risk Manager/ Occupational Risk Manager of Transnet Limited of any hazardous situations which may arise from work being performed either by the contractor or his sub-contractor.
- 16) Copies of all appointments required by the act must be given to * Health and Safety Section / Risk Manager / Occupational Risk Manager of Transnet Limited.
- 17) The contractor shall ensure that a Health and Safety File is available which shall include all documentation as required by the Act, copy of his and his subcontractors Risk Assessment and Health and Safety Plan.
- 18) All incidents referred to in Section 24 of the Act involving the contractor and his subcontractor on Transnet Ltd premises, shall be reported as prescribed. Transnet Ltd hereby obtains an interest in the issue of any investigation, formal inquiry conducted in terms of Section 31 and 32 of the Act into any incident involving the contractor, his subcontractor, any person or machinery under his control on Transnet Ltd premises.
- 19) No alcohol or any other intoxicating substance shall be allowed on Transnet Ltd premises. The contractor shall not allow anyone under or suspected to be under the influence of alcohol or any other intoxicating substance on Transnet Ltd premises.
- 20) Contractor to ensure its employees undergo medical surveillance as required by legislation
- 21) Contractor will be required to provide monthly safety performance reports and statistics
- 22) A letter of good standing in terms of Section 80 (Employer to register with the Compensation Commissioner) of the Compensation for Occupational Injuries and Disease Act 1993 (Act 130 of 1993) must also be furnished.
- 23) All clauses in the contract pertaining health and safety forms an integral part of the contract and if not complied with may be construed as breach of contract.

*As applicable

Tenderer OH & S Management System Questionnaire

This questionnaire forms part of TFR tender evaluation process and is to be completed by all Tenderer's and submitted with their tender offer. The objective of the questionnaire is to provide an overview of the status of the Tenderer's OH&S management system. Tenderer's will be required to verify their responses noted in their questionnaire by providing evidence of their ability and capacity in relevant matters. **TFR will verify accuracy of this information during the physical visit as part of the tender evaluation.**

The information provided in this questionnaire is an accurate summary of the company's occupational health and safety management system.		
Company Name:		
Signed:	Name:	
Position:	Date:	
Tender Description:		
Tender Number:		
Tenderer OH&S Management System Questionnaire	Yes	No
1. OH&S Policy and Management		
- Is there a written company health and safety policy? - If yes provide a copy of the policy		
- Does the company have an OH&S Management system e.g NOSA, OHSAS, IRCA System etc - If yes provide details		
- Is there a company OH&S Management System, procedures manual or plan? - If yes provide a copy of the content page(s)		
- Are health and safety responsibilities clearly identified for all levels of Management and employees? - If yes provide details		
2. Safe Work Practices and Procedures		
- Are safe operating procedures or specific safety instructions relevant to its operations available? - If yes provide a summary listing of procedures or instructions		

<p>- Is there a register of injury document? If yes provide a copy</p>		
<p>- Are Risk Assessments conducted and appropriate techniques used? - If yes provide details</p>		
3. OH&S Training		
<p>Describe briefly how health and safety training is conducted in your company:</p>		
<p>- Is a record maintained of all training and induction programs undertaken for employees in your company? - If yes provide examples of safety training records</p>		
4. Health and Safety Workplace Inspection		
<p>- Are regular health and safety inspections at worksites undertaken? -If yes provide details</p>		
<p>- Is there a procedure by which employees can report hazards at workplaces? - If yes provide details</p>		
5. Health and Safety Consultation		
<p>- Is there a workplace health and safety committee?</p>		
<p>- Are employees involved in decision making over OH&S matters? - If yes provide details</p>		
<p>- Are there employee elected health and safety representatives? - Comments</p>		
6. OH&S Performance Monitoring		
<p>- Is there a system for recording and analysing health and safety performance statistics including injuries and</p>		

incidents? - If yes provide details		
- Are employees regularly provided with information on company health and safety performance? - If yes provide details		
Is company registered with workmen's compensation and up to date? - If yes provide proof of letter of good standing		
- Has the company ever been convicted of an occupational health and safety offence? - If yes provide details		

Safety Performance Report

Monthly DIFR for previous months

Previous Year	No of Disabling Injuries	Total Number of employees	DIFR per month
Jan			
Feb			
Mar			
Apr			
May			
Jun			
Jul			
Aug			
Sep			
Oct			
Nov			
Dec			

DIFR = Number of Disabling injuries x 200000 divided by number of manhours worked for the period

=====

Signed
(Tenderer)

TRANSNET LIMITED / CONTRACTORS / SUB-CONTRACTORS

CONTRACTUAL SAFETY CLAUSES WHICH WILL FORM PART OF ANY RESULTING CONTRACT

The parties agree on the following arrangements according to section 37 (2) of the Occupational Health and Safety Act, 1993 (Act 85 of 1993) to ensure compliance by the mandatory with provisions of the Act.

- 1) That the contractor is an “employer” in his own right as defined in section 1 of Act 85 of 1993 and that he must fulfill all his obligations as an employer in terms of the Act.
- 2) The contractor shall comply with the requirements of Act 85 of 1993 in its entirety.
- 3) Where special permits are required, such as electrical switching, hot work permits, etc. the contractor shall obtain them from a person designated by Transnet Limited for this purpose, and all requirements of the contractor must rigidly comply with the permit.
- 4) The contractor shall conduct a risk assessment of the work to be performed by a competent person prior to the commencement of work, to identify risks and hazards that persons may be exposed to, analyse and evaluate identified hazards.
- 5) The contractor shall have a documented Health and Safety Plan based on the risks and hazards identified before commencement of work.
- 6) The Health and Safety Plan shall include the following:
 - 6.1 The safety management structure to be instituted with all appointments in terms of the Act and Regulations
 - 6.2 The safe working methods and procedures to be implemented to ensure work is performed in compliance to the Act.
 - 6.3 The safety equipment, devices and clothing to be made available by the contractor to his employees.
 - 6.4 The site access control measures pertaining to health and safety to be implemented.
 - 6.5 Control measures for ensuring that the Health and Safety Plan is maintained and monitored for the duration of the contract.
- 7) The contractor shall ensure that all work is performed under the close supervision of a person trained to understand the hazards associated with the work performed and who has authority to ensure that the necessary precautionary measures are implemented.
- 8) The contractor must appoint a Health and Safety Co-ordinator to liaise with Transnet Limited on matters pertaining to occupational health and safety.
- 9) The appointed Safety Co-ordinator must liaise at least once a week with the* Health and Safety Section / Risk Manager /Occupational Risk Manager of Transnet Limited.
- 10) The contractor shall furnish the* Health and Safety Section/ Risk Manager/ Occupational Risk Manager of Transnet Limited immediately with full particulars of any sub-contractor which he may involve in the contract in order that the sub-contractor himself can be made aware of all the clauses in this contract pertaining to health and safety.
- 11) The contractor shall stop any subcontractor from executing work which is not in accordance with the Health and Safety Plan or which poses a threat to health and safety of persons.

- 12) The contractor shall ensure that all his employees and visitors undergoes health and safety induction pertaining to the hazards prevalent, proof of such training must be kept on file.
- 13) In the event where the risk assessment reveals the risk relating to working from an elevated position the contractor shall cause the designation of a competent person, responsible for the preparation of a Fall Protection Plan.
- 14) The Fall Protection Plan shall include:
 - 14.1 A risk assessment of all work carried out from an elevated position
 - 14.2 Procedures and methods to address all the identified risks per location
 - 14.3 Evaluation of employees physical and psychological fitness necessary to work at elevated position.
 - 14.4 The training of employees working from an elevated position.
 - 14.5 Procedure addressing the inspection, testing and maintenance of all fall protection equipment.
- 15) The contractor shall advise the * Health and Safety Section / Risk Manager/ Occupational Risk Manager of Transnet Limited of any hazardous situations which may arise from work being performed either by the contractor or his sub-contractor.
- 16) Copies of all appointments required by the act must be given to * Health and Safety Section / Risk Manager / Occupational Risk Manager of Transnet Limited.
- 17) The contractor shall ensure that a Health and Safety File is available which shall include all documentation as required by the Act, copy of his and his subcontractors Risk Assessment and Health and Safety Plan.
- 18) All incidents referred to in Section 24 of the Act involving the contractor and his subcontractor on Transnet Ltd premises, shall be reported as prescribed. Transnet Ltd hereby obtains an interest in the issue of any investigation, formal inquiry conducted in terms of Section 31 and 32 of the Act into any incident involving the contractor, his subcontractor, any person or machinery under his control on Transnet Ltd premises.
- 19) No alcohol or any other intoxicating substance shall be allowed on Transnet Ltd premises. The contractor shall not allow anyone under or suspected to be under the influence of alcohol or any other intoxicating substance on Transnet Ltd premises.
- 20) Contractor to ensure its employees undergo medical surveillance as required by legislation
- 21) Contractor will be required to provide monthly safety performance reports and statistics
- 22) A letter of good standing in terms of Section 80 (Employer to register with the Compensation Commissioner) of the Compensation for Occupational Injuries and Disease Act 1993 (Act 130 of 1993) must also be furnished.
- 23) All clauses in the contract pertaining health and safety forms an integral part of the contract and if not complied with may be construed as breach of contract.

*As applicable

Tenderer OH & S Management System Questionnaire

This questionnaire forms part of TFR tender evaluation process and is to be completed by all Tenderer's and submitted with their tender offer. The objective of the questionnaire is to provide an overview of the status of the Tenderer's OH&S management system. Tenderer's will be required to verify their responses noted in their questionnaire by providing evidence of their ability and capacity in relevant matters. **TFR will verify accuracy of this information during the physical visit as part of the tender evaluation.**

The information provided in this questionnaire is an accurate summary of the company's occupational health and safety management system.		
Company Name:		
Signed:	Name:	
Position:	Date:	
Tender Description:		
Tender Number:		
Tenderer OH&S Management System Questionnaire	Yes	No
1. OH&S Policy and Management		
- Is there a written company health and safety policy? - If yes provide a copy of the policy		
- Does the company have an OH&S Management system e.g NOSA, OHSAS, IRCA System etc - If yes provide details		
- Is there a company OH&S Management System, procedures manual or plan? - If yes provide a copy of the content page(s)		
- Are health and safety responsibilities clearly identified for all levels of Management and employees? - If yes provide details		
2. Safe Work Practices and Procedures		
- Are safe operating procedures or specific safety instructions relevant to its operations available? - If yes provide a summary listing of procedures or instructions		

<p>- Is there a register of injury document? If yes provide a copy</p>		
<p>- Are Risk Assessments conducted and appropriate techniques used? - If yes provide details</p>		
3. OH&S Training		
<p>Describe briefly how health and safety training is conducted in your company:</p>		
<p>- Is a record maintained of all training and induction programs undertaken for employees in your company? - If yes provide examples of safety training records</p>		
4. Health and Safety Workplace Inspection		
<p>- Are regular health and safety inspections at worksites undertaken? -If yes provide details</p>		
<p>- Is there a procedure by which employees can report hazards at workplaces? - If yes provide details</p>		
5. Health and Safety Consultation		
<p>- Is there a workplace health and safety committee?</p>		
<p>- Are employees involved in decision making over OH&S matters? - If yes provide details</p>		
<p>- Are there employee elected health and safety representatives? - Comments</p>		
6. OH&S Performance Monitoring		
<p>- Is there a system for recording and analysing health and safety performance statistics including injuries and</p>		

incidents? - If yes provide details		
- Are employees regularly provided with information on company health and safety performance? - If yes provide details		
Is company registered with workmen's compensation and up to date? - If yes provide proof of letter of good standing		
- Has the company ever been convicted of an occupational health and safety offence? - If yes provide details		

Safety Performance Report

Monthly DIFR for previous months

Previous Year	No of Disabling Injuries	Total Number of employees	DIFR per month
Jan			
Feb			
Mar			
Apr			
May			
Jun			
Jul			
Aug			
Sep			
Oct			
Nov			
Dec			

DIFR = Number of Disabling injuries x 200000 divided by number of manhours worked for the period

=====

Signed
(Tenderer)

TRANSNET LIMITED / CONTRACTORS / SUB-CONTRACTORS

CONTRACTUAL SAFETY CLAUSES WHICH WILL FORM PART OF ANY RESULTING CONTRACT

The parties agree on the following arrangements according to section 37 (2) of the Occupational Health and Safety Act, 1993 (Act 85 of 1993) to ensure compliance by the mandatory with provisions of the Act.

- 1) That the contractor is an “employer” in his own right as defined in section 1 of Act 85 of 1993 and that he must fulfill all his obligations as an employer in terms of the Act.
- 2) The contractor shall comply with the requirements of Act 85 of 1993 in its entirety.
- 3) Where special permits are required, such as electrical switching, hot work permits, etc. the contractor shall obtain them from a person designated by Transnet Limited for this purpose, and all requirements of the contractor must rigidly comply with the permit.
- 4) The contractor shall conduct a risk assessment of the work to be performed by a competent person prior to the commencement of work, to identify risks and hazards that persons may be exposed to, analyse and evaluate identified hazards.
- 5) The contractor shall have a documented Health and Safety Plan based on the risks and hazards identified before commencement of work.
- 6) The Health and Safety Plan shall include the following:
 - 6.1 The safety management structure to be instituted with all appointments in terms of the Act and Regulations
 - 6.2 The safe working methods and procedures to be implemented to ensure work is performed in compliance to the Act.
 - 6.3 The safety equipment, devices and clothing to be made available by the contractor to his employees.
 - 6.4 The site access control measures pertaining to health and safety to be implemented.
 - 6.5 Control measures for ensuring that the Health and Safety Plan is maintained and monitored for the duration of the contract.
- 7) The contractor shall ensure that all work is performed under the close supervision of a person trained to understand the hazards associated with the work performed and who has authority to ensure that the necessary precautionary measures are implemented.
- 8) The contractor must appoint a Health and Safety Co-ordinator to liaise with Transnet Limited on matters pertaining to occupational health and safety.
- 9) The appointed Safety Co-ordinator must liaise at least once a week with the* Health and Safety Section / Risk Manager /Occupational Risk Manager of Transnet Limited.
- 10) The contractor shall furnish the* Health and Safety Section/ Risk Manager/ Occupational Risk Manager of Transnet Limited immediately with full particulars of any sub-contractor which he may involve in the contract in order that the sub-contractor himself can be made aware of all the clauses in this contract pertaining to health and safety.
- 11) The contractor shall stop any subcontractor from executing work which is not in accordance with the Health and Safety Plan or which poses a threat to health and safety of persons.

- 12) The contractor shall ensure that all his employees and visitors undergoes health and safety induction pertaining to the hazards prevalent, proof of such training must be kept on file.
- 13) In the event where the risk assessment reveals the risk relating to working from an elevated position the contractor shall cause the designation of a competent person, responsible for the preparation of a Fall Protection Plan.
- 14) The Fall Protection Plan shall include:
 - 14.1 A risk assessment of all work carried out from an elevated position
 - 14.2 Procedures and methods to address all the identified risks per location
 - 14.3 Evaluation of employees physical and psychological fitness necessary to work at elevated position.
 - 14.4 The training of employees working from an elevated position.
 - 14.5 Procedure addressing the inspection, testing and maintenance of all fall protection equipment.
- 15) The contractor shall advise the * Health and Safety Section / Risk Manager/ Occupational Risk Manager of Transnet Limited of any hazardous situations which may arise from work being performed either by the contractor or his sub-contractor.
- 16) Copies of all appointments required by the act must be given to * Health and Safety Section / Risk Manager / Occupational Risk Manager of Transnet Limited.
- 17) The contractor shall ensure that a Health and Safety File is available which shall include all documentation as required by the Act, copy of his and his subcontractors Risk Assessment and Health and Safety Plan.
- 18) All incidents referred to in Section 24 of the Act involving the contractor and his subcontractor on Transnet Ltd premises, shall be reported as prescribed. Transnet Ltd hereby obtains an interest in the issue of any investigation, formal inquiry conducted in terms of Section 31 and 32 of the Act into any incident involving the contractor, his subcontractor, any person or machinery under his control on Transnet Ltd premises.
- 19) No alcohol or any other intoxicating substance shall be allowed on Transnet Ltd premises. The contractor shall not allow anyone under or suspected to be under the influence of alcohol or any other intoxicating substance on Transnet Ltd premises.
- 20) Contractor to ensure its employees undergo medical surveillance as required by legislation
- 21) Contractor will be required to provide monthly safety performance reports and statistics
- 22) A letter of good standing in terms of Section 80 (Employer to register with the Compensation Commissioner) of the Compensation for Occupational Injuries and Disease Act 1993 (Act 130 of 1993) must also be furnished.
- 23) All clauses in the contract pertaining health and safety forms an integral part of the contract and if not complied with may be construed as breach of contract.

*As applicable

Tenderer OH & S Management System Questionnaire

This questionnaire forms part of TFR tender evaluation process and is to be completed by all Tenderer's and submitted with their tender offer. The objective of the questionnaire is to provide an overview of the status of the Tenderer's OH&S management system. Tenderer's will be required to verify their responses noted in their questionnaire by providing evidence of their ability and capacity in relevant matters. **TFR will verify accuracy of this information during the physical visit as part of the tender evaluation.**

The information provided in this questionnaire is an accurate summary of the company's occupational health and safety management system.		
Company Name:		
Signed:	Name:	
Position:	Date:	
Tender Description:		
Tender Number:		
Tenderer OH&S Management System Questionnaire	Yes	No
1. OH&S Policy and Management		
- Is there a written company health and safety policy? - If yes provide a copy of the policy		
- Does the company have an OH&S Management system e.g NOSA, OHSAS, IRCA System etc - If yes provide details		
- Is there a company OH&S Management System, procedures manual or plan? - If yes provide a copy of the content page(s)		
- Are health and safety responsibilities clearly identified for all levels of Management and employees? - If yes provide details		
2. Safe Work Practices and Procedures		
- Are safe operating procedures or specific safety instructions relevant to its operations available? - If yes provide a summary listing of procedures or instructions		

<p>- Is there a register of injury document? If yes provide a copy</p>		
<p>- Are Risk Assessments conducted and appropriate techniques used? - If yes provide details</p>		
3. OH&S Training		
<p>Describe briefly how health and safety training is conducted in your company:</p>		
<p>- Is a record maintained of all training and induction programs undertaken for employees in your company? - If yes provide examples of safety training records</p>		
4. Health and Safety Workplace Inspection		
<p>- Are regular health and safety inspections at worksites undertaken? -If yes provide details</p>		
<p>- Is there a procedure by which employees can report hazards at workplaces? - If yes provide details</p>		
5. Health and Safety Consultation		
<p>- Is there a workplace health and safety committee?</p>		
<p>- Are employees involved in decision making over OH&S matters? - If yes provide details</p>		
<p>- Are there employee elected health and safety representatives? - Comments</p>		
6. OH&S Performance Monitoring		
<p>- Is there a system for recording and analysing health and safety performance statistics including injuries and</p>		

incidents? - If yes provide details		
- Are employees regularly provided with information on company health and safety performance? - If yes provide details		
Is company registered with workmen's compensation and up to date? - If yes provide proof of letter of good standing		
- Has the company ever been convicted of an occupational health and safety offence? - If yes provide details		

Safety Performance Report

Monthly DIFR for previous months

Previous Year	No of Disabling Injuries	Total Number of employees	DIFR per month
Jan			
Feb			
Mar			
Apr			
May			
Jun			
Jul			
Aug			
Sep			
Oct			
Nov			
Dec			

DIFR = Number of Disabling injuries x 200000 divided by number of manhours worked for the period

=====

Signed
(Tenderer)

TRANSNET LIMITED / CONTRACTORS / SUB-CONTRACTORS

CONTRACTUAL SAFETY CLAUSES WHICH WILL FORM PART OF ANY RESULTING CONTRACT

The parties agree on the following arrangements according to section 37 (2) of the Occupational Health and Safety Act, 1993 (Act 85 of 1993) to ensure compliance by the mandatory with provisions of the Act.

- 1) That the contractor is an “employer” in his own right as defined in section 1 of Act 85 of 1993 and that he must fulfill all his obligations as an employer in terms of the Act.
- 2) The contractor shall comply with the requirements of Act 85 of 1993 in its entirety.
- 3) Where special permits are required, such as electrical switching, hot work permits, etc. the contractor shall obtain them from a person designated by Transnet Limited for this purpose, and all requirements of the contractor must rigidly comply with the permit.
- 4) The contractor shall conduct a risk assessment of the work to be performed by a competent person prior to the commencement of work, to identify risks and hazards that persons may be exposed to, analyse and evaluate identified hazards.
- 5) The contractor shall have a documented Health and Safety Plan based on the risks and hazards identified before commencement of work.
- 6) The Health and Safety Plan shall include the following:
 - 6.1 The safety management structure to be instituted with all appointments in terms of the Act and Regulations
 - 6.2 The safe working methods and procedures to be implemented to ensure work is performed in compliance to the Act.
 - 6.3 The safety equipment, devices and clothing to be made available by the contractor to his employees.
 - 6.4 The site access control measures pertaining to health and safety to be implemented.
 - 6.5 Control measures for ensuring that the Health and Safety Plan is maintained and monitored for the duration of the contract.
- 7) The contractor shall ensure that all work is performed under the close supervision of a person trained to understand the hazards associated with the work performed and who has authority to ensure that the necessary precautionary measures are implemented.
- 8) The contractor must appoint a Health and Safety Co-ordinator to liaise with Transnet Limited on matters pertaining to occupational health and safety.
- 9) The appointed Safety Co-ordinator must liaise at least once a week with the* Health and Safety Section / Risk Manager /Occupational Risk Manager of Transnet Limited.
- 10) The contractor shall furnish the* Health and Safety Section/ Risk Manager/ Occupational Risk Manager of Transnet Limited immediately with full particulars of any sub-contractor which he may involve in the contract in order that the sub-contractor himself can be made aware of all the clauses in this contract pertaining to health and safety.
- 11) The contractor shall stop any subcontractor from executing work which is not in accordance with the Health and Safety Plan or which poses a threat to health and safety of persons.

- 12) The contractor shall ensure that all his employees and visitors undergoes health and safety induction pertaining to the hazards prevalent, proof of such training must be kept on file.
- 13) In the event where the risk assessment reveals the risk relating to working from an elevated position the contractor shall cause the designation of a competent person, responsible for the preparation of a Fall Protection Plan.
- 14) The Fall Protection Plan shall include:
 - 14.1 A risk assessment of all work carried out from an elevated position
 - 14.2 Procedures and methods to address all the identified risks per location
 - 14.3 Evaluation of employees physical and psychological fitness necessary to work at elevated position.
 - 14.4 The training of employees working from an elevated position.
 - 14.5 Procedure addressing the inspection, testing and maintenance of all fall protection equipment.
- 15) The contractor shall advise the * Health and Safety Section / Risk Manager/ Occupational Risk Manager of Transnet Limited of any hazardous situations which may arise from work being performed either by the contractor or his sub-contractor.
- 16) Copies of all appointments required by the act must be given to * Health and Safety Section / Risk Manager / Occupational Risk Manager of Transnet Limited.
- 17) The contractor shall ensure that a Health and Safety File is available which shall include all documentation as required by the Act, copy of his and his subcontractors Risk Assessment and Health and Safety Plan.
- 18) All incidents referred to in Section 24 of the Act involving the contractor and his subcontractor on Transnet Ltd premises, shall be reported as prescribed. Transnet Ltd hereby obtains an interest in the issue of any investigation, formal inquiry conducted in terms of Section 31 and 32 of the Act into any incident involving the contractor, his subcontractor, any person or machinery under his control on Transnet Ltd premises.
- 19) No alcohol or any other intoxicating substance shall be allowed on Transnet Ltd premises. The contractor shall not allow anyone under or suspected to be under the influence of alcohol or any other intoxicating substance on Transnet Ltd premises.
- 20) Contractor to ensure its employees undergo medical surveillance as required by legislation
- 21) Contractor will be required to provide monthly safety performance reports and statistics
- 22) A letter of good standing in terms of Section 80 (Employer to register with the Compensation Commissioner) of the Compensation for Occupational Injuries and Disease Act 1993 (Act 130 of 1993) must also be furnished.
- 23) All clauses in the contract pertaining health and safety forms an integral part of the contract and if not complied with may be construed as breach of contract.

*As applicable

Tenderer OH & S Management System Questionnaire

This questionnaire forms part of TFR tender evaluation process and is to be completed by all Tenderer's and submitted with their tender offer. The objective of the questionnaire is to provide an overview of the status of the Tenderer's OH&S management system. Tenderer's will be required to verify their responses noted in their questionnaire by providing evidence of their ability and capacity in relevant matters. **TFR will verify accuracy of this information during the physical visit as part of the tender evaluation.**

The information provided in this questionnaire is an accurate summary of the company's occupational health and safety management system.		
Company Name:		
Signed:	Name:	
Position:	Date:	
Tender Description:		
Tender Number:		
Tenderer OH&S Management System Questionnaire	Yes	No
1. OH&S Policy and Management		
- Is there a written company health and safety policy? - If yes provide a copy of the policy		
- Does the company have an OH&S Management system e.g NOSA, OHSAS, IRCA System etc - If yes provide details		
- Is there a company OH&S Management System, procedures manual or plan? - If yes provide a copy of the content page(s)		
- Are health and safety responsibilities clearly identified for all levels of Management and employees? - If yes provide details		
2. Safe Work Practices and Procedures		
- Are safe operating procedures or specific safety instructions relevant to its operations available? - If yes provide a summary listing of procedures or instructions		

<p>- Is there a register of injury document? If yes provide a copy</p>		
<p>- Are Risk Assessments conducted and appropriate techniques used? - If yes provide details</p>		
3. OH&S Training		
<p>Describe briefly how health and safety training is conducted in your company:</p>		
<p>- Is a record maintained of all training and induction programs undertaken for employees in your company? - If yes provide examples of safety training records</p>		
4. Health and Safety Workplace Inspection		
<p>- Are regular health and safety inspections at worksites undertaken? -If yes provide details</p>		
<p>- Is there a procedure by which employees can report hazards at workplaces? - If yes provide details</p>		
5. Health and Safety Consultation		
<p>- Is there a workplace health and safety committee?</p>		
<p>- Are employees involved in decision making over OH&S matters? - If yes provide details</p>		
<p>- Are there employee elected health and safety representatives? - Comments</p>		
6. OH&S Performance Monitoring		
<p>- Is there a system for recording and analysing health and safety performance statistics including injuries and</p>		

incidents? - If yes provide details		
- Are employees regularly provided with information on company health and safety performance? - If yes provide details		
Is company registered with workmen's compensation and up to date? - If yes provide proof of letter of good standing		
- Has the company ever been convicted of an occupational health and safety offence? - If yes provide details		

Safety Performance Report

Monthly DIFR for previous months

Previous Year	No of Disabling Injuries	Total Number of employees	DIFR per month
Jan			
Feb			
Mar			
Apr			
May			
Jun			
Jul			
Aug			
Sep			
Oct			
Nov			
Dec			

DIFR = Number of Disabling injuries x 200000 divided by number of manhours worked for the period

=====

Signed
(Tenderer)

TRANSNET LIMITED / CONTRACTORS / SUB-CONTRACTORS

CONTRACTUAL SAFETY CLAUSES WHICH WILL FORM PART OF ANY RESULTING CONTRACT

The parties agree on the following arrangements according to section 37 (2) of the Occupational Health and Safety Act, 1993 (Act 85 of 1993) to ensure compliance by the mandatory with provisions of the Act.

- 1) That the contractor is an “employer” in his own right as defined in section 1 of Act 85 of 1993 and that he must fulfill all his obligations as an employer in terms of the Act.
- 2) The contractor shall comply with the requirements of Act 85 of 1993 in its entirety.
- 3) Where special permits are required, such as electrical switching, hot work permits, etc. the contractor shall obtain them from a person designated by Transnet Limited for this purpose, and all requirements of the contractor must rigidly comply with the permit.
- 4) The contractor shall conduct a risk assessment of the work to be performed by a competent person prior to the commencement of work, to identify risks and hazards that persons may be exposed to, analyse and evaluate identified hazards.
- 5) The contractor shall have a documented Health and Safety Plan based on the risks and hazards identified before commencement of work.
- 6) The Health and Safety Plan shall include the following:
 - 6.1 The safety management structure to be instituted with all appointments in terms of the Act and Regulations
 - 6.2 The safe working methods and procedures to be implemented to ensure work is performed in compliance to the Act.
 - 6.3 The safety equipment, devices and clothing to be made available by the contractor to his employees.
 - 6.4 The site access control measures pertaining to health and safety to be implemented.
 - 6.5 Control measures for ensuring that the Health and Safety Plan is maintained and monitored for the duration of the contract.
- 7) The contractor shall ensure that all work is performed under the close supervision of a person trained to understand the hazards associated with the work performed and who has authority to ensure that the necessary precautionary measures are implemented.
- 8) The contractor must appoint a Health and Safety Co-ordinator to liaise with Transnet Limited on matters pertaining to occupational health and safety.
- 9) The appointed Safety Co-ordinator must liaise at least once a week with the* Health and Safety Section / Risk Manager /Occupational Risk Manager of Transnet Limited.
- 10) The contractor shall furnish the* Health and Safety Section/ Risk Manager/ Occupational Risk Manager of Transnet Limited immediately with full particulars of any sub-contractor which he may involve in the contract in order that the sub-contractor himself can be made aware of all the clauses in this contract pertaining to health and safety.
- 11) The contractor shall stop any subcontractor from executing work which is not in accordance with the Health and Safety Plan or which poses a threat to health and safety of persons.

- 12) The contractor shall ensure that all his employees and visitors undergoes health and safety induction pertaining to the hazards prevalent, proof of such training must be kept on file.
- 13) In the event where the risk assessment reveals the risk relating to working from an elevated position the contractor shall cause the designation of a competent person, responsible for the preparation of a Fall Protection Plan.
- 14) The Fall Protection Plan shall include:
 - 14.1 A risk assessment of all work carried out from an elevated position
 - 14.2 Procedures and methods to address all the identified risks per location
 - 14.3 Evaluation of employees physical and psychological fitness necessary to work at elevated position.
 - 14.4 The training of employees working from an elevated position.
 - 14.5 Procedure addressing the inspection, testing and maintenance of all fall protection equipment.
- 15) The contractor shall advise the * Health and Safety Section / Risk Manager/ Occupational Risk Manager of Transnet Limited of any hazardous situations which may arise from work being performed either by the contractor or his sub-contractor.
- 16) Copies of all appointments required by the act must be given to * Health and Safety Section / Risk Manager / Occupational Risk Manager of Transnet Limited.
- 17) The contractor shall ensure that a Health and Safety File is available which shall include all documentation as required by the Act, copy of his and his subcontractors Risk Assessment and Health and Safety Plan.
- 18) All incidents referred to in Section 24 of the Act involving the contractor and his subcontractor on Transnet Ltd premises, shall be reported as prescribed. Transnet Ltd hereby obtains an interest in the issue of any investigation, formal inquiry conducted in terms of Section 31 and 32 of the Act into any incident involving the contractor, his subcontractor, any person or machinery under his control on Transnet Ltd premises.
- 19) No alcohol or any other intoxicating substance shall be allowed on Transnet Ltd premises. The contractor shall not allow anyone under or suspected to be under the influence of alcohol or any other intoxicating substance on Transnet Ltd premises.
- 20) Contractor to ensure its employees undergo medical surveillance as required by legislation
- 21) Contractor will be required to provide monthly safety performance reports and statistics
- 22) A letter of good standing in terms of Section 80 (Employer to register with the Compensation Commissioner) of the Compensation for Occupational Injuries and Disease Act 1993 (Act 130 of 1993) must also be furnished.
- 23) All clauses in the contract pertaining health and safety forms an integral part of the contract and if not complied with may be construed as breach of contract.

*As applicable

Tenderer OH & S Management System Questionnaire

This questionnaire forms part of TFR tender evaluation process and is to be completed by all Tenderer's and submitted with their tender offer. The objective of the questionnaire is to provide an overview of the status of the Tenderer's OH&S management system. Tenderer's will be required to verify their responses noted in their questionnaire by providing evidence of their ability and capacity in relevant matters. **TFR will verify accuracy of this information during the physical visit as part of the tender evaluation.**

The information provided in this questionnaire is an accurate summary of the company's occupational health and safety management system.		
Company Name:		
Signed:	Name:	
Position:	Date:	
Tender Description:		
Tender Number:		
Tenderer OH&S Management System Questionnaire	Yes	No
1. OH&S Policy and Management		
- Is there a written company health and safety policy? - If yes provide a copy of the policy		
- Does the company have an OH&S Management system e.g NOSA, OHSAS, IRCA System etc - If yes provide details		
- Is there a company OH&S Management System, procedures manual or plan? - If yes provide a copy of the content page(s)		
- Are health and safety responsibilities clearly identified for all levels of Management and employees? - If yes provide details		
2. Safe Work Practices and Procedures		
- Are safe operating procedures or specific safety instructions relevant to its operations available? - If yes provide a summary listing of procedures or instructions		

<p>- Is there a register of injury document? If yes provide a copy</p>		
<p>- Are Risk Assessments conducted and appropriate techniques used? - If yes provide details</p>		
3. OH&S Training		
<p>Describe briefly how health and safety training is conducted in your company:</p>		
<p>- Is a record maintained of all training and induction programs undertaken for employees in your company? - If yes provide examples of safety training records</p>		
4. Health and Safety Workplace Inspection		
<p>- Are regular health and safety inspections at worksites undertaken? -If yes provide details</p>		
<p>- Is there a procedure by which employees can report hazards at workplaces? - If yes provide details</p>		
5. Health and Safety Consultation		
<p>- Is there a workplace health and safety committee?</p>		
<p>- Are employees involved in decision making over OH&S matters? - If yes provide details</p>		
<p>- Are there employee elected health and safety representatives? - Comments</p>		
6. OH&S Performance Monitoring		
<p>- Is there a system for recording and analysing health and safety performance statistics including injuries and</p>		

incidents? - If yes provide details		
- Are employees regularly provided with information on company health and safety performance? - If yes provide details		
Is company registered with workmen's compensation and up to date? - If yes provide proof of letter of good standing		
- Has the company ever been convicted of an occupational health and safety offence? - If yes provide details		

Safety Performance Report

Monthly DIFR for previous months

Previous Year	No of Disabling Injuries	Total Number of employees	DIFR per month
Jan			
Feb			
Mar			
Apr			
May			
Jun			
Jul			
Aug			
Sep			
Oct			
Nov			
Dec			

DIFR = Number of Disabling injuries x 200000 divided by number of manhours worked for the period

=====
Signed
(Tenderer)

TRANSNET SOC LIMITED / CONTRACTORS / SUB-CONTRACTORS

CONTRACTUAL SAFETY CLAUSES WHICH WILL FORM PART OF ANY RESULTING CONTRACT

The parties agree on the following arrangements according to section 37 (2) of the Occupational Health and Safety Act, 1993 (Act 85 of 1993) to ensure compliance by the mandatory with provisions of the Act.

- 1) That the Contractor is an “employer” in his own right as defined in section 1 of Act 85 of 1993 and that he must fulfil all his obligations as an employer in terms of the Act.
- 2) The Contractor shall comply with the requirements of Act 85 of 1993 in its entirety.
- 3) Where special permits are required, such as electrical switching, hot work permits, etc. the Contractor shall obtain them from a person designated by Transnet SOC Limited for this purpose, and all requirements of the Contractor must rigidly comply with the permit.
- 4) The Contractor shall conduct a risk assessment of the work to be performed by a competent person prior to the commencement of work, to identify risks and hazards that persons may be exposed to, analyse and evaluate identified hazards.
- 5) The Contractor shall have a documented Health and Safety Plan based on the risks and hazards identified before commencement of work.
- 6) The Health and Safety Plan shall include the following:
 - 6.1 The safety management structure to be instituted with all appointments in terms of the Act and Regulations
 - 6.2 The safe working methods and procedures to be implemented to ensure work is performed in compliance to the Act.
 - 6.3 The safety equipment, devices and clothing to be made available by the Contractor to his employees.
 - 6.4 The site access control measures pertaining to health and safety to be implemented.
 - 6.5 Control measures for ensuring that the Health and Safety Plan is maintained and monitored for the duration of the contract.
- 7) The Contractor shall ensure that all work is performed under the close supervision of a person trained to understand the hazards associated with the work performed and who has authority to ensure that the necessary precautionary measures are implemented.
- 8) The Contractor must appoint a Health and Safety Co-ordinator to liaise with Transnet SOC Limited on matters pertaining to occupational health and safety.
- 9) The appointed Safety Co-ordinator must liaise at least once a week with the* Health and Safety Section / Risk Manager /Occupational Risk Manager of Transnet SOC Limited.
- 10) The Contractor shall furnish the* Health and Safety Section/ Risk Manager/ Occupational Risk Manager of Transnet SOC Limited immediately with full particulars of any sub-contractor which he may involve in the contract in order that the subContractor himself can be made aware of all the clauses in this contract pertaining to health and safety.
- 11) The Contractor shall stop any subcontractor from executing work which is not in accordance with the Health and Safety Plan or which poses a threat to health and safety of persons.

- 12) The Contractor shall ensure that all his employees and visitors undergoes health and safety induction pertaining to the hazards prevalent, proof of such training must be kept on file.
- 13) In the event where the risk assessment reveals the risk relating to working from an elevated position the Contractor shall cause the designation of a competent person, responsible for the preparation of a Fall Protection Plan.
- 14) The Fall Protection Plan shall include:
 - 14.1 A risk assessment of all work carried out from an elevated position
 - 14.2 Procedures and methods to address all the identified risks per location
 - 14.3 Evaluation of employees physical and psychological fitness necessary to work at elevated position.
 - 14.4 The training of employees working from an elevated position.
 - 14.5 Procedure addressing the inspection, testing and maintenance of all fall protection equipment.
- 15) The Contractor shall advise the * Health and Safety Section / Risk Manager/ Occupational Risk Manager of Transnet SOC Limited of any hazardous situations which may arise from work being performed either by the Contractor or his sub-contractor.
- 16) Copies of all appointments required by the act must be given to * Health and Safety Section / Risk Manager / Occupational Risk Manager of Transnet SOC Limited.
- 17) The Contractor shall ensure that a Health and Safety File is available which shall include all documentation as required by the Act, copy of his and his sub-contractors Risk Assessment and Health and Safety Plan.
- 18) All incidents referred to in Section 24 of the Act involving the Contractor and his sub-contractor on Transnet Ltd premises, shall be reported as prescribed. Transnet Ltd hereby obtains an interest in the issue of any investigation, formal inquiry conducted in terms of Section 31 and 32 of the Act into any incident involving the Contractor, his sub-contractor, any person or machinery under his control on Transnet Ltd premises.
- 19) No alcohol or any other intoxicating substance shall be allowed on Transnet Ltd premises. The Contractor shall not allow anyone under or suspected to be under the influence of alcohol or any other intoxicating substance on Transnet Ltd premises.
- 20) Contractor to ensure its employees undergo medical surveillance as required by legislation
- 21) Contractor will be required to provide monthly safety performance reports and statistics
- 22) A letter of good standing in terms of Section 80 (Employer to register with the Compensation Commissioner) of the Compensation for Occupational Injuries and Disease Act 1993 (Act 130 of 1993) must also be furnished.
- 23) All clauses in the contract pertaining health and safety forms an integral part of the contract and if not complied with may be construed as breach of contract.

*As applicable

Tenderer OH & S Management System Questionnaire

This questionnaire forms part of TFR tender evaluation process and is to be completed by all Tenderer's and submitted with their tender offer. The objective of the questionnaire is to provide an overview of the status of the Tenderer's OH&S management system. Tenderer's will be required to verify their responses noted in their questionnaire by providing evidence of their ability and capacity in relevant matters. **TFR will verify accuracy of this information during the physical visit as part of the tender evaluation.**

The information provided in this questionnaire is an accurate summary of the company's occupational health and safety management system.		
Company Name:		
Signed:	Name:	
Position:	Date:	
Tender Description:		
Tender Number:		
Tenderer OH&S Management System Questionnaire	Yes	No
1. OH&S Policy and Management		
- Is there a written company health and safety policy? - If yes provide a copy of the policy		
- Does the company have an OH&S Management system e.g NOSA, OHSAS, IRCA System etc - If yes provide details		
- Is there a company OH&S Management System, procedures manual or plan? - If yes provide a copy of the content page(s)		
- Are health and safety responsibilities clearly identified for all levels of Management and employees? - If yes provide details		
2. Safe Work Practices and Procedures		
- Are safe operating procedures or specific safety instructions relevant to its operations available? - If yes provide a summary listing of procedures or instructions		
- Is there a register of injury document? If yes provide a copy		
- Are Risk Assessments conducted and appropriate		

<p>techniques used?</p> <p>- If yes provide details</p>		
3. OH&S Training		
<p>Describe briefly how health and safety training is conducted in your company:</p>		
<p>- Is a record maintained of all training and induction programs undertaken for employees in your company?</p> <p>- If yes provide examples of safety training records</p>		
4. Health and Safety Workplace Inspection		
<p>- Are regular health and safety inspections at worksites undertaken?</p> <p>-If yes provide details</p>		
<p>- Is there a procedure by which employees can report hazards at workplaces?</p> <p>- If yes provide details</p>		
5. Health and Safety Consultation		
<p>- Is there a workplace health and safety committee?</p>		
<p>- Are employees involved in decision making over OH&S matters?</p> <p>- If yes provide details</p>		
<p>- Are there employee elected health and safety representatives?</p> <p>- Comments</p>		
6. OH&S Performance Monitoring		
<p>- Is there a system for recording and analysing health and safety performance statistics including injuries and incidents?</p> <p>- If yes provide details</p>		
<p>- Are employees regularly provided with information on company health and safety performance?</p>		

- If yes provide details		
Is company registered with workmen's compensation and up to date?		
- If yes provide proof of letter of good standing		
- Has the company ever been convicted of an occupational health and safety offence?		
- If yes provide details		

Safety Performance Report

Monthly DIFR for previous months

Previous Year	No of Disabling Injuries	Total Number of employees	DIFR per month
Jan			
Feb			
Mar			
Apr			
May			
Jun			
Jul			
Aug			
Sep			
Oct			
Nov			
Dec			

DIFR = Number of Disabling injuries x 200000 divided by number of man-hours worked for the period

=====
Signed
(Tenderer)

TRANSNET LIMITED / CONTRACTORS / SUB-CONTRACTORS

CONTRACTUAL SAFETY CLAUSES WHICH WILL FORM PART OF ANY RESULTING CONTRACT

The parties agree on the following arrangements according to section 37 (2) of the Occupational Health and Safety Act, 1993 (Act 85 of 1993) to ensure compliance by the mandatory with provisions of the Act.

- 1) That the contractor is an “employer” in his own right as defined in section 1 of Act 85 of 1993 and that he must fulfill all his obligations as an employer in terms of the Act.
- 2) The contractor shall comply with the requirements of Act 85 of 1993 in its entirety.
- 3) Where special permits are required, such as electrical switching, hot work permits, etc. the contractor shall obtain them from a person designated by Transnet Limited for this purpose, and all requirements of the contractor must rigidly comply with the permit.
- 4) The contractor shall conduct a risk assessment of the work to be performed by a competent person prior to the commencement of work, to identify risks and hazards that persons may be exposed to, analyse and evaluate identified hazards.
- 5) The contractor shall have a documented Health and Safety Plan based on the risks and hazards identified before commencement of work.
- 6) The Health and Safety Plan shall include the following:
 - 6.1 The safety management structure to be instituted with all appointments in terms of the Act and Regulations
 - 6.2 The safe working methods and procedures to be implemented to ensure work is performed in compliance to the Act.
 - 6.3 The safety equipment, devices and clothing to be made available by the contractor to his employees.
 - 6.4 The site access control measures pertaining to health and safety to be implemented.
 - 6.5 Control measures for ensuring that the Health and Safety Plan is maintained and monitored for the duration of the contract.
- 7) The contractor shall ensure that all work is performed under the close supervision of a person trained to understand the hazards associated with the work performed and who has authority to ensure that the necessary precautionary measures are implemented.
- 8) The contractor must appoint a Health and Safety Co-ordinator to liaise with Transnet Limited on matters pertaining to occupational health and safety.
- 9) The appointed Safety Co-ordinator must liaise at least once a week with the* Health and Safety Section / Risk Manager /Occupational Risk Manager of Transnet Limited.
- 10) The contractor shall furnish the* Health and Safety Section/ Risk Manager/ Occupational Risk Manager of Transnet Limited immediately with full particulars of any sub-contractor which he may involve in the contract in order that the sub-contractor himself can be made aware of all the clauses in this contract pertaining to health and safety.
- 11) The contractor shall stop any subcontractor from executing work which is not in accordance with the Health and Safety Plan or which poses a threat to health and safety of persons.

- 12) The contractor shall ensure that all his employees and visitors undergoes health and safety induction pertaining to the hazards prevalent, proof of such training must be kept on file.
- 13) In the event where the risk assessment reveals the risk relating to working from an elevated position the contractor shall cause the designation of a competent person, responsible for the preparation of a Fall Protection Plan.
- 14) The Fall Protection Plan shall include:
 - 14.1 A risk assessment of all work carried out from an elevated position
 - 14.2 Procedures and methods to address all the identified risks per location
 - 14.3 Evaluation of employees physical and psychological fitness necessary to work at elevated position.
 - 14.4 The training of employees working from an elevated position.
 - 14.5 Procedure addressing the inspection, testing and maintenance of all fall protection equipment.
- 15) The contractor shall advise the * Health and Safety Section / Risk Manager/ Occupational Risk Manager of Transnet Limited of any hazardous situations which may arise from work being performed either by the contractor or his sub-contractor.
- 16) Copies of all appointments required by the act must be given to * Health and Safety Section / Risk Manager / Occupational Risk Manager of Transnet Limited.
- 17) The contractor shall ensure that a Health and Safety File is available which shall include all documentation as required by the Act, copy of his and his subcontractors Risk Assessment and Health and Safety Plan.
- 18) All incidents referred to in Section 24 of the Act involving the contractor and his subcontractor on Transnet Ltd premises, shall be reported as prescribed. Transnet Ltd hereby obtains an interest in the issue of any investigation, formal inquiry conducted in terms of Section 31 and 32 of the Act into any incident involving the contractor, his subcontractor, any person or machinery under his control on Transnet Ltd premises.
- 19) No alcohol or any other intoxicating substance shall be allowed on Transnet Ltd premises. The contractor shall not allow anyone under or suspected to be under the influence of alcohol or any other intoxicating substance on Transnet Ltd premises.
- 20) Contractor to ensure its employees undergo medical surveillance as required by legislation
- 21) Contractor will be required to provide monthly safety performance reports and statistics
- 22) A letter of good standing in terms of Section 80 (Employer to register with the Compensation Commissioner) of the Compensation for Occupational Injuries and Disease Act 1993 (Act 130 of 1993) must also be furnished.
- 23) All clauses in the contract pertaining health and safety forms an integral part of the contract and if not complied with may be construed as breach of contract.

*As applicable

Tenderer OH & S Management System Questionnaire

This questionnaire forms part of TFR tender evaluation process and is to be completed by all Tenderer's and submitted with their tender offer. The objective of the questionnaire is to provide an overview of the status of the Tenderer's OH&S management system. Tenderer's will be required to verify their responses noted in their questionnaire by providing evidence of their ability and capacity in relevant matters. **TFR will verify accuracy of this information during the physical visit as part of the tender evaluation.**

The information provided in this questionnaire is an accurate summary of the company's occupational health and safety management system.		
Company Name:		
Signed:	Name:	
Position:	Date:	
Tender Description:		
Tender Number:		
Tenderer OH&S Management System Questionnaire	Yes	No
1. OH&S Policy and Management		
- Is there a written company health and safety policy? - If yes provide a copy of the policy		
- Does the company have an OH&S Management system e.g NOSA, OHSAS, IRCA System etc - If yes provide details		
- Is there a company OH&S Management System, procedures manual or plan? - If yes provide a copy of the content page(s)		
- Are health and safety responsibilities clearly identified for all levels of Management and employees? - If yes provide details		
2. Safe Work Practices and Procedures		
- Are safe operating procedures or specific safety instructions relevant to its operations available? - If yes provide a summary listing of procedures or instructions		

<p>- Is there a register of injury document? If yes provide a copy</p>		
<p>- Are Risk Assessments conducted and appropriate techniques used? - If yes provide details</p>		
3. OH&S Training		
<p>Describe briefly how health and safety training is conducted in your company:</p>		
<p>- Is a record maintained of all training and induction programs undertaken for employees in your company? - If yes provide examples of safety training records</p>		
4. Health and Safety Workplace Inspection		
<p>- Are regular health and safety inspections at worksites undertaken? -If yes provide details</p>		
<p>- Is there a procedure by which employees can report hazards at workplaces? - If yes provide details</p>		
5. Health and Safety Consultation		
<p>- Is there a workplace health and safety committee?</p>		
<p>- Are employees involved in decision making over OH&S matters? - If yes provide details</p>		
<p>- Are there employee elected health and safety representatives? - Comments</p>		
6. OH&S Performance Monitoring		
<p>- Is there a system for recording and analysing health and safety performance statistics including injuries and</p>		

incidents? - If yes provide details		
- Are employees regularly provided with information on company health and safety performance? - If yes provide details		
Is company registered with workmen's compensation and up to date? - If yes provide proof of letter of good standing		
- Has the company ever been convicted of an occupational health and safety offence? - If yes provide details		

Safety Performance Report

Monthly DIFR for previous months

Previous Year	No of Disabling Injuries	Total Number of employees	DIFR per month
Jan			
Feb			
Mar			
Apr			
May			
Jun			
Jul			
Aug			
Sep			
Oct			
Nov			
Dec			

DIFR = Number of Disabling injuries x 200000 divided by number of manhours worked for the period

=====

Signed
(Tenderer)



delivering on our commitment *to you*

Suppliers Code of Conduct

PREVIEW COPY ONLY



Suppliers Code of Conduct

Transnet aims to achieve the best value for money when buying or selling goods and obtaining services. This, however, must be done in an open and fair manner that supports and drives a competitive economy. Underpinning our process are several acts and policies that any supplier dealing with Transnet must understand and support.

These are:

- » Transnet Procurement Policy - A guide for tenderers;
- » Section 217 of the Constitution - the five pillars of Public PSCM (Procurement and Supply Chain Management): fair, equitable, transparent, competitive and cost effective;
- » The Public Finance Management Act (PFMA);
- » The Broad Based Black Economic Empowerment Act (BBBEE); and
- » The Anti-Corruption Act.

This code of conduct has been compiled to formally apprise Transnet Suppliers of Transnet's expectations regarding behaviour and conduct of its Suppliers.

Prohibition of Bribes, Kickbacks, Unlawful Payments, and Other Corrupt Practices

Transnet is in the process of transforming itself into a self-sustaining State Owned Enterprise, actively competing in the logistics industry. Our aim is to become a world class, profitable, logistics organisation. As such, our transformation is focused on adopting a performance culture and to adopt behaviours that will enable this transformation.

Transnet will not participate in corrupt practices. Therefore, it expects its suppliers to act in a similar manner.

- » Transnet and its employees will follow the laws of this country and keep accurate business records that reflect actual transactions with, and payments to, our suppliers.



- » Employees must not accept or request money or anything of value, directly or indirectly, from suppliers.

Employees may not receive anything that is calculated to:

- Illegally influence their judgement or conduct or to influence the outcome of a sourcing activity;
 - Win or retain business or to influence any act or decision of any person involved in sourcing decisions; gain an improper advantage.
- » There may be times when a supplier is confronted with fraudulent or corrupt behaviour of Transnet employees. We expect our suppliers to use our "Tip-offs Anonymous" Hotline to report these acts - 0800 003 056.

Transnet is firmly committed to free and competitive enterprise.

- » Suppliers are expected to comply with all applicable laws and regulations regarding fair competition and antitrust practices
- » Transnet does not engage non-value adding agents or representatives solely for the purpose of increasing BBBEE spend (fronting).

Transnet's relationship with suppliers requires us to clearly define requirements, to exchange information and share mutual benefits.

- » Generally, suppliers have their own business standards and regulations. Although Transnet cannot control the actions of our suppliers, we will not tolerate any illegal activities.



These include, but are not limited to:

- Misrepresentation of their product (origin of manufacture, specifications, intellectual property rights, etc);
 - Collusion;
 - Failure to disclose accurate information required during the sourcing activity (ownership financial situation, BBBEE status, etc.);
 - Corrupt activities listed above; and harassment, intimidation or other aggressive actions towards Transnet employees.
- >> Suppliers must be evaluated and approved before any materials, components, products or services are purchased from them. Rigorous due diligence must be conducted and the supplier is expected to participate in an honest and straight forward manner.
- >> Suppliers must record and report facts accurately, honestly and objectively. Financial records must be accurate in all material respects.

Conflict of Interest

A conflict of interest arises when personal interests or activities influence (or appear to influence) the ability to act in the best interests of Transnet. Examples are:

- >> Doing business with family members.
- >> Having a financial interest in another company in our industry.



Show that you support good business practice by logging onto www.transnet-suppliers.net and completing the form.

This will allow us to confirm that you have received, and agree to, the terms and conditions set out in our Suppliers Code of Conduct.

TIP-OFFS ANONYMOUS HOTLINE
0800 003 056

TRANSNET



**STANDARD TERMS AND CONDITIONS OF CONTRACT
FOR THE PROVISION OF SERVICES TO TRANSNET**

FORM US7 – SERVICES

“PREVIEW COPY ONLY”

TABLE OF CONTENTS

1.....	INTRODUCTION	3
2.....	DEFINITIONS	3
3.....	INTERPRETATION	7
4.....	NATURE AND SCOPE	8
5.....	AUTHORITY OF PARTIES	8
6.....	WARRANTIES.....	9
7.....	TRANSNET'S OBLIGATIONS.....	11
8.....	GENERAL OBLIGATIONS OF THE SUPPLIER.....	11
9.....	FEES AND EXPENSES.....	13
10.....	INVOICING AND PAYMENT.....	13
11.....	FEE ADJUSTMENTS.....	14
12.....	INTELLECTUAL PROPERTY RIGHTS.....	14
13.....	SUPPLIER'S PERSONNEL.....	17
14.....	LIMITATION OF LIABILITY.....	18
15.....	INSURANCES.....	19
16.....	CONFIDENTIALITY.....	19
17.....	TOTAL OR PARTIAL FAILURE TO PERFORM THE SCOPE OF SERVICES.....	22
18.....	TERM AND TERMINATION.....	22
19.....	CONSEQUENCE OF TERMINATION.....	23
20.....	ASSIGNMENT.....	24
21.....	FORCE MAJEURE.....	24
22.....	EQUALITY AND DIVERSITY.....	25
23.....	NON-WAIVER.....	25
24.....	PARTIAL INVALIDITY.....	25
25.....	DISPUTE RESOLUTION.....	25
26.....	ADDRESSES FOR NOTICES.....	26
27.....	WHOLE AND ONLY AGREEMENT.....	26
28.....	AMENDMENT AND CHANGE CONTROL.....	27
29.....	GOVERNING LAW.....	27
30.....	COUNTERPARTS.....	27

SCHEDULE 1 - ADDRESSES FOR NOTICES

SCHEDULE 2 - SCHEDULE OF REQUIREMENTS and / or WORK ORDER/S

SCHEDULE 3 - NON-DISCLOSURE AGREEMENT

1. INTRODUCTION

When an Agreement is entered into between Transnet and the Supplier of Services to Transnet, these Standard Terms and Conditions of Contract, the General Tender Conditions, a Schedule of Requirements and/or Work Order(s) including such special conditions as applicable, and any terms in the associated tender documents, exclusively govern the provision of Services by the Supplier to Transnet.

2. DEFINITIONS

Where the following words or phrases are used in the Agreement, such words or phrases shall have the meaning assigned thereto in this clause, except where the context clearly requires otherwise:

- 2.1. **"AFSA"** means the Arbitration Foundation of South Africa;
- 2.2. **"Agreement"** means the Agreement and its associated schedules and/or annexures and/or appendices, including the Schedule of Requirements and/or Work Order(s), specifications for the Services and such special conditions as shall apply to the Agreement, together with the General Tender Conditions and any additional provisions in the associated bid documents tendered by the Supplier (as agreed between the Parties), which collectively and exclusively govern the provision of Services by the Supplier to Transnet;
- 2.3. **"Background Intellectual Property"** means all Intellectual Property introduced and required by either Party to give effect to their obligations under the Agreement owned in whole or in part by or licensed to either Party or their affiliates prior to the Commencement Date or developed after the Commencement Date otherwise pursuant to the Agreement;
- 2.4. **"Business Day(s)"** means Mondays to Fridays between 07:30 and 16:00, excluding public holidays;
- 2.5. **"Commencement Date"** means the effective date at which time the Supplier's provision of Services to Transnet in terms of the Agreement shall commence, as detailed in Schedule 2 hereto (SCHEDULE OF REQUIREMENTS / WORK ORDER);
- 2.6. **"Confidential Information"** means any information or other data, whether in written, oral, graphic or in any other form such as in documents, papers, memoranda, correspondence, notebooks, reports, drawings, diagrams, discs, articles, samples, test results, prototypes, designs, plans, formulae, patents, or inventor's certificates, which a Party discloses or provides to the other Party (intentionally or unintentionally, or as a result of one Party permitting the

Respondent's Signature

Date & Company Stamp

representative of the other Party to visit any of its premises), or which otherwise becomes known to a Party, and which is not in the public domain and includes, without limiting the generality of the term –

- (a) information relating to methods of operation, data and plans of the disclosing Party;
- (b) the contents of the Agreement;
- (c) private and personal details of employees or clients of the disclosing Party or any other person where an onus rests on the disclosing Party to maintain the confidentiality of such information;
- (d) any information disclosed by either Party and which is clearly marked as being confidential or secret;
- (e) information relating to the strategic objectives and planning of the disclosing Party relating to its existing and planned future business activities;
- (f) information relating to the past, present and future research and development of the disclosing Party;
- (g) information relating to the business activities, business relationships, products, services, customers, clients and Subcontractors of the disclosing Party where an onus rests on the disclosing Party to maintain the confidentiality of such information;
- (h) information contained in the software and associated material and documentation belonging to the disclosing Party;
- (i) technical and scientific information, Know-How and trade secrets of a disclosing Party including inventions, applications and processes;
- (j) Copyright works;
- (k) commercial, financial and marketing information;
- (l) data concerning architecture, demonstrations, tools and techniques, processes, machinery and equipment of the disclosing Party;
- (m) plans, designs, concepts, drawings, functional and technical requirements and specifications of the disclosing Party;
- (n) information concerning faults or defects in goods, equipment, hardware or software or the incidence of such faults or defects; and

Respondent's Signature

Date & Company Stamp

- (o) information concerning the charges, Fees and / or costs of the disclosing Party or its authorised Subcontractors, or their methods, practices or service performance levels actually achieved;
- 2.7. **“Copyright”** means the right in expressions, procedures, methods of operations or mathematical concepts, computer program codes, compilations of data or other material, literary works, musical works, artistic works, sound recordings, broadcasts, program carrying signals, published editions, photographic works, or cinematographic works of the copyright owner to do or to authorise the doing of certain acts specified in respect of the different categories of works;
- 2.8. **“Default”** means any breach of the obligations of either Party (including but not limited to fundamental breach or breach of a fundamental term) or any Default, act, omission, negligence or statement of either Party, its employees, agents or Subcontractors in connection with or in relation to the subject of the Agreement and in respect of which such Party is liable to the other;
- 2.9. **“Deliverable(s)”** means any and all works of authorship, products and materials developed, written, prepared, assembled, integrated, modified or provided by the Supplier in relation to the Services;
- 2.10. **“Designs”** mean registered designs and/or design applications and will include the monopoly right granted for the protection of an independently created industrial design including designs dictated essentially by technical or functional considerations as well as topographies of integrated circuits and integrated circuits;
- 2.11. **“Fee(s)”** shall mean the agreed Fees for the Services to be purchased from the Supplier by Transnet, as detailed in the Schedule of Requirements or Work Order(s), issued in accordance with the Agreement, as amended by mutual agreement between the Parties and in accordance with the provisions of the Agreement from time to time;
- 2.12. **“Foreground Intellectual Property”** means all Intellectual Property developed by either Party pursuant to the Agreement;
- 2.13. **“Intellectual Property”** means Patents, Designs, Know-How, Copyright and Trade Marks and all rights having equivalent or similar effect which may exist anywhere in the world and includes all future additions and improvements to the Intellectual Property;
- 2.14. **“Know-How”** means all Confidential Information of whatever nature relating to the Intellectual Property and its exploitation as well as all other Confidential Information generally relating to

Respondent's Signature

Date & Company Stamp

Transnet's field of technology, including technical information, processing or manufacturing techniques, Designs, specifications, formulae, systems, processes, information concerning materials and marketing and business information in general;

- 2.15. **"Materials"** means the Deliverables, the Supplier Materials and the Third Party Materials;
- 2.16. **"Parties"** mean the Parties to the Agreement together with their subsidiaries, divisions, business units, successors-in-title and their assigns;
- 2.17. **"Party"** means either one of these Parties;
- 2.18. **"Patents"** mean registered patents and patent applications, once the latter have proceeded to grant, and includes a right granted for any inventions, products or processes in all fields of technology;
- 2.19. **"Permitted Purpose"** means any activity or process to be undertaken or supervised by Personnel or employees of one Party during the term of the Agreement, for which purpose authorised disclosure of the other Party's Confidential Information or Intellectual Property is a prerequisite in order to enable such activity or process to be accomplished;
- 2.20. **"Personnel"** means any partner, employee, agent, consultant, independent associate or supplier, Subcontractor and the staff of such Subcontractor, or other authorised representative of either Party;
- 2.21. **"Purchase Order(s)"** means official orders issued by an operating division of Transnet to the Supplier for the provision of Services;
- 2.22. **"Schedule of Requirements"** means Schedule 2 hereto, unless substituted by a Work Order or Work Orders, as defined;
- 2.23. **"Service(s)"** means the Service(s) provided to Transnet by the Supplier, pursuant to the Schedule of Requirements or Work Order(s) in terms of the Agreement;
- 2.24. **"Service Level Agreement"** or **"SLA"** means the processes, deliverables, key performance indicators and performance standards relating to the Services to be provided by the Supplier;
- 2.25. **"Subcontract"** means any contract or agreement or proposed contract or agreement between the Supplier and any third party whereby that third party agrees to provide to the Supplier the Services or any part thereof;
- 2.26. **"Subcontractor"** means the third party with whom the Supplier enters into a Subcontract;

Respondent's Signature

Date & Company Stamp

- 2.27. **“Supplier Materials”** means all works of authorship, products and materials (including, but not limited to, data, diagrams, charts, reports, specifications, studies, inventions, software, software development tools, methodologies, ideas, methods, processes, concepts and techniques) owned by, or licensed to, the Supplier prior to the Commencement Date or independently developed by the Supplier outside the scope of the Agreement at no expense to Transnet, and used by the Supplier in the performance of the Services;
- 2.28. **“Tax Invoice”** means the document as required by Section 20 of the Value-Added Tax Act, 89 of 1991;
- 2.29. **“Third Party Material”** means software, software development tools, methodologies, ideas, methods, processes, concepts and techniques owned by, or licensed to a third party and used by the Supplier in the performance of the Services;
- 2.30. **“Trade Marks”** mean registered trade marks and trade mark applications and includes any sign or logo, or combination of signs and/or logos capable of distinguishing the goods or services of one undertaking from those of another undertaking;
- 2.31. **“VAT”** means Value-Added Tax in terms of the Value-Added Tax Act, 89 of 1991; and
- 2.32. **“Work Order(s)”** means a detailed scope of work for a Service required by Transnet, including timeframes, Deliverable, Fees and costs for the supply of the Service to Transnet, which may be appended to the Agreement from time to time.

3. INTERPRETATION

- 3.1. Clause headings in the Agreement are included for ease of reference only and do not form part of the Agreement for the purposes of interpretation or for any other purpose. No provision shall be construed against or interpreted to the disadvantage of either Party hereto by reason of such Party having or being deemed to have structured or drafted such provision.
- 3.2. Any term, word, acronym or phrase used in the Agreement, other than those defined under the clause heading “DEFINITIONS,” shall be given its plain English meaning, and those terms, words, acronyms, and phrases used in the Agreement will be interpreted in accordance with the generally accepted meanings accorded thereto.
- 3.3. A reference to the singular incorporates a reference to the plural and vice versa.
- 3.4. A reference to natural persons incorporates a reference to legal persons and vice versa.
- 3.5. A reference to a particular gender incorporates a reference to the other genders.

Respondent's Signature

Date & Company Stamp

4. NATURE AND SCOPE

- 4.1. The Agreement is an agreement under the terms and conditions of which the Supplier will arrange for the provision to Transnet of the Services which meet the requirements of Transnet, the delivery of which Services is controlled by means of Purchase Orders to be issued by Transnet and executed by the Supplier, in accordance with the Agreement.
- 4.2. Such Purchase Orders shall be agreed between the Parties from time to time, subject to the terms of the Schedule of Requirements and / or relevant Work Order(s).
- 4.3. Each properly executed Purchase Order forms an inseparable part of the Agreement as if it were fully incorporated into the body of the Agreement.
- 4.4. During the period of the Agreement, both Parties can make written suggestions for amendments to the Schedule of Requirements or Work Orders, in accordance with procedures set out in clause 28 (AMENDMENT AND CHANGE CONTROL) below. A Party will advise the other Party within 14 (fourteen) Business Days, or such other period as mutually agreed, whether the amendment is acceptable.
- 4.5. Insofar as any term, provision or condition in the Schedule of Requirements and/or Work Order(s) conflicts with a like term, provision or condition in the Agreement and/or a Purchase Order, or where the Agreement is silent on the matter, the term, provision or condition in the Schedule of Requirements and/or Work Order(s) shall prevail.
- 4.6. Time will be of the essence and the Supplier will perform its obligations under the Agreement in accordance with the timeframe(s) (if any) set out in the relevant schedule, save that the Supplier will not be liable under this clause if it is unable to meet such obligation within the time required as a direct result of any act or omission by Transnet and it has used its best endeavours to advise Transnet of such act or omission. In the event of such delay, any time deadlines detailed in the relevant schedule shall be extended by a period equal to the period of that delay.

5. AUTHORITY OF PARTIES

- 5.1. Nothing in the Agreement will constitute or be deemed to constitute a partnership between the Parties, or constitute or be deemed to constitute the Parties as agents or employees of one another for any purpose or in any form whatsoever.
- 5.2. Neither Party shall be entitled to, or have the power or authority to enter into an agreement in the name of the other; or give any warranty, representation or undertaking on the other's behalf;

Respondent's Signature

Date & Company Stamp

or create any liability against the other or bind the other's credit in any way or for any purpose whatsoever.

6. WARRANTIES

- 6.1. The Supplier warrants to Transnet that -
- (a) it has full capacity and authority to enter into and to perform the Agreement and that the Agreement is executed by a duly authorised representatives of the Supplier;
 - (b) it will discharge its obligations under the Agreement and any annexure or schedule hereto with all due skill, care and diligence;
 - (c) it will be solely responsible for the payment of remuneration and associated benefits, if any, of its Personnel and for withholding and remitting income tax for its Personnel in conformance with any applicable laws and regulations;
 - (d) it will procure licences for Transnet in respect of all Third Party Material detailed in the Work Order(s), and will procure the right for Transnet to take such copies (in whole or in part) of such Third Party Materials as it may reasonably require for the purposes of back-up for archiving and disaster recovery; and
 - (e) the use or possession by Transnet of any Materials will not subject Transnet to any claim for infringement of any Intellectual Property Rights of any third party.
- 6.2. The Supplier warrants that it will perform its obligations under the Agreement in accordance with the Service Levels as defined in the relevant schedule. Transnet may at its discretion audit compliance with the Service Levels, provided that any such audit is carried out with reasonable prior notice and in a reasonable way so as not to have an adverse effect on the performance of the Services. Without prejudice to sub-clause 6.3 below, in the event that the Supplier fails to meet the Service Levels, Transnet may claim appropriate service credits or invoke a retention of Fees as detailed in the relevant schedule and/or Work Order.
- 6.3. The Supplier warrants that for a period of 90 (ninety) days from Acceptance of the Deliverables they will, if properly used, conform in all materials respects with the requirements set out in the relevant schedule. The Supplier will at its expense remedy any such non-conformance as soon as possible but in any event within 30 (thirty) days of notification by Transnet. In the event that the Supplier fails or is unable to remedy such non-conformance within such time-scale, Transnet will be entitled to employ a third party to do so in place of the Supplier and any excess charges or costs incurred by Transnet as a result shall be paid by the Supplier.

Respondent's Signature

Date & Company Stamp

- 6.4. The Supplier will remedy any defect within 14 (fourteen) days of being notified of that defect by Transnet in writing.
- 6.5. The Supplier will not be liable to remedy any problem arising from or caused by any modification made by Transnet to the Deliverables, or any part thereof, without the prior approval of the Supplier.
- 6.6. The Supplier shall advise Transnet of the effects of any steps proposed by Transnet pursuant to sub-clause 6.5 above, including but not limited to any cost implications or any disruption or delay in the performance of the Services. The Parties agree that any changes to the Services, including the charges for the Services or any timetables for delivery of the Services, will be agreed in accordance with the change control procedure, as set out in clause 28 (AMENDMENT AND CHANGE CONTROL).
- 6.7. The Supplier warrants that -
- (a) it has, using the most up-to-date software available, tested for (and deleted) all commonly known viruses in the Materials and for all viruses known by the Supplier at the date of the relevant Work Order; and
 - (b) at the time of delivery to Transnet, the Materials do not contain any trojan horse, worm, logic bomb, time bomb, back door, trap door, keys or other harmful components.
- The Supplier agrees that, in the event that a virus is found, it will at its own expense use its best endeavours to assist Transnet in reducing the effect of the virus and, particularly in the event that a virus causes loss of operational efficiency or loss of data, to assist Transnet to the same extent to mitigate such losses and to restore Transnet to its original operating efficiency.
- 6.8. The Supplier undertakes to comply with South Africa's general privacy protection in terms of the Bill of Rights (Section 14) in connection with the Agreement and shall procure that its Personnel shall observe the provisions of such Act (as applicable) or any amendments and re-enactments thereof and any regulations made pursuant thereto.
- 6.9. The Supplier warrants that it has taken all reasonable precautions to ensure that, in the event of a disaster, the impact of such disaster on the ability of the Supplier to comply with its obligations under the Agreement will be reduced to the greatest extent possible, and that the Supplier shall ensure that it has appropriate, tested and documented recovery arrangements in place.
- 6.10. In compliance with the National Railway Safety Regulator Act, 16 of 2002, the Supplier shall ensure that the Services, to be supplied to Transnet under the terms and conditions of the

Respondent's Signature

Date & Company Stamp

Agreement, comply fully with the Specifications as set forth in Schedule 2 hereto, and shall thereby adhere to railway safety requirements and/or regulations. Permission for the engagement of a Subcontractor by the Supplier, as applicable, shall be subject to a review of the capability of the proposed Subcontractor to comply with the specified railway safety requirements and/or regulations. The Supplier and/or its Subcontractor shall grant Transnet access, during the term of the Agreement, to review any safety-related activities, including the coordination of such activities across all parts of its organisation.

7. TRANSNET'S OBLIGATIONS

- 7.1. Transnet undertakes to promptly comply with any reasonable request by the Supplier for information, including information concerning Transnet's operations and activities, that relates to the Services as may be necessary for the Supplier to perform the Services, but for no other purpose. However, Transnet's compliance with any request for information is subject to any internal security rules and requirements and subject to the observance by the Supplier of its confidentiality obligations under the Agreement.
- 7.2. The Supplier shall give Transnet reasonable notice of any information it requires in accordance with sub-clause 7.1 above.
- 7.3. Subject to clause 13 (SUPPLIER'S PERSONNEL), Transnet agrees to provide the Supplier or its Personnel such access to and use of its facilities as is necessary to allow the Supplier to perform its obligations under the Agreement.

8. GENERAL OBLIGATIONS OF THE SUPPLIER

- 8.1. The Supplier shall –
 - (a) respond promptly to all complaints and enquiries from Transnet;
 - (b) inform Transnet immediately of any dispute or complaint arising in relation to the provision of the Services;
 - (c) conduct its business in a professional manner that will reflect positively upon the Supplier and the Supplier's Services;
 - (d) keep full records clearly indicating all transactions concluded by the Supplier relating to the performance of the Services and keep such records for at least 5 (five) years from the date of each such transaction;

Respondent's Signature

Date & Company Stamp

- (e) obtain, and at all times maintain in full force and effect, any and all licences, permits and the like required under applicable laws for the provision of the Services and the conduct of the business and activities of the Supplier;
- (f) observe and ensure compliance with all requirements and obligations as set out in the labour and related legislation of South Africa, including the Occupational Health and Safety Act, 85 of 1993; and
- (g) comply with all applicable environmental legislation and regulations, and demonstrate sound environmental policies, management and performance.

8.2. The Supplier acknowledges and agrees that it shall at all times -

- (a) render the Services and perform all its duties with honesty and integrity;
- (b) communicate openly and honestly with Transnet and demonstrate a commitment to performing the Services timeously, efficiently and to the required standards;
- (c) endeavour to provide the highest possible standards of service and professionalism, with a reasonable degree of care and diligence;
- (d) use its best endeavours and make every diligent effort to meet agreed deadlines;
- (e) treat its own Personnel, as well as all Transnet's officers, employees, agents and consultants, with fairness and courtesy and respect for their human rights;
- (f) practice and promote its own internal policies aimed at prohibiting and preventing unfair discrimination (as further referred to in clause 22 – EQUALITY AND DIVERSITY);
- (g) treat all enquiries from Transnet in connection with the Services with courtesy and respond to all enquiries promptly and efficiently. Where the Supplier is unable to comply with the provisions of this sub-clause, the Supplier will advise Transnet of the delay and the reasons therefor and will keep Transnet informed of progress made regarding the enquiry;
- (h) when requested by Transnet, provide clear and accurate information regarding the Supplier's own policies and procedures, excluding Know-How and other Confidential Information, except where a non-disclosure undertaking has been entered into between the Parties;
- (i) not allow a conflict of interest to develop between its own interests (or the interests of any of its other customers) and the interests of Transnet;

Respondent's Signature

Date & Company Stamp

- (j) not accept or offer, nor allow, induce or promote the acceptance or offering of any gratuity, enticement, incentive or gift that could reasonably be regarded as bribery or an attempt to otherwise exert undue influence over the recipient;
- (k) not mislead Transnet or its officers, employees and stakeholders, whether by act or omission;
- (l) not otherwise act in an unethical manner or do anything which could reasonably be expected to damage or tarnish Transnet's reputation or business image; and
- (m) immediately report to Transnet any unethical, fraudulent or otherwise unlawful conduct of which it becomes aware in connection with Transnet or the provision of Services.

9. FEES AND EXPENSES

- 9.1. In consideration of the provision of the Services, Transnet will pay to the Supplier the Fees detailed in the relevant schedule or Work Order.
- 9.2. Transnet will not be invoiced for materials used in the provision of the Services save for those materials (if any) set out in the Work Order and accepted by Transnet or in any relevant Work Order (which will be invoiced to Transnet at cost).
- 9.3. Unless otherwise agreed in a schedule or Work Order, Transnet will reimburse to the Supplier all reasonable and proper expenses incurred directly and solely in connection with the provision of the Services, provided that all such expenses -
 - (a) are agreed by Transnet in advance;
 - (b) are incurred in accordance with Transnet's standard travel and expenses policies;
 - (c) are passed on to Transnet at cost with no administration fee; and
 - (d) will only be reimbursed if supported by relevant receipts.
- 9.4. All Tax Invoices relating to Fees, out of pocket expenses and, if applicable, travel and accommodation costs, will provide the detail for each of the Personnel carrying out the Services and incurring the expenses, and the Tax Invoice will, where appropriate, include VAT as a separate item.

10. INVOICING AND PAYMENT

- 10.1. Transnet shall pay the Supplier the amounts stipulated in the relevant schedule or Work Order, subject to the terms and conditions of the Agreement.

Respondent's Signature

Date & Company Stamp

- 10.2. Transnet shall pay such amounts to the Supplier, upon receipt of a correct and undisputed Tax Invoice together with the supporting documentation as specified in the Schedule of Requirements or Work Order appended hereto, once the undisputed Tax Invoices, or such portion of the Tax Invoices which are undisputed become due and payable to the Supplier for the provision of the Services, in terms of sub-clause 10.4 below.
- 10.3. All Fees and other sums payable under the Agreement are exclusive of VAT, which will be payable at the applicable rate.
- 10.4. Unless otherwise provided for in the Schedule of Requirements or Work Order(s) appended to the Agreement, Tax Invoices shall be submitted together with a month-end statement. Payment against such month-end statement shall be made by Transnet within 30 (thirty) days after date of receipt by Transnet of the statement together with all undisputed Tax Invoices and supporting documentation.
- 10.5. Where the payment of any Tax Invoice, or any part thereof which is not in dispute, is not made in accordance with this clause 10, the Supplier shall be entitled to charge interest on the outstanding amount, at The Standard Bank of South Africa's prime rate of interest in force, for the period from the due date of payment until the outstanding amount is paid.

11. FEE ADJUSTMENTS

- 11.1. Fees for Services rendered in terms of the Agreement shall be subject to review as indicated in the Schedule of Requirements or Work Orders annexed hereto from time to time.
- 11.2. No less than 2 (two) months prior to any proposed Fee adjustment, the Parties shall commence negotiations for Fees for the next period or as otherwise indicated and appended hereto.
- 11.3. Should Transnet and the Supplier fail to reach an agreement on Fees for the successive period, either Party shall be entitled to terminate the Agreement and/or the relevant Work Order after giving 30 (thirty) days written notice to the other.
- 11.4. Neither Party shall have any claim against the other of whatsoever nature by reason of such cancellation as envisaged in sub-clause 11.3 above.

12. INTELLECTUAL PROPERTY RIGHTS

12.1. Title to Confidential Information

- (a) Transnet will retain all right, title and interest in and to its Confidential Information and Background Intellectual Property and the Supplier acknowledges that it has no claim of

Respondent's Signature

Date & Company Stamp

any nature in and to the Confidential Information and Background Intellectual Property that is proprietary to Transnet. For the avoidance of doubt, all the Supplier's Background Intellectual Property shall remain vested in the Supplier.

- (b) Transnet shall grant to the Supplier an irrevocable royalty free non-exclusive licence to use Transnet's Background Intellectual Property only for the Permitted Purpose. This licence shall not permit the Supplier to sub-license to other parties.
- (c) The Supplier shall grant to Transnet an irrevocable, royalty free, non-exclusive licence to use the Supplier's Background Intellectual Property for the Permitted Purpose. This licence shall not permit Transnet to sub-license to other parties.
- (d) The Supplier shall grant Transnet access to the Supplier's Background Intellectual Property on terms which shall be bona fide negotiated between the Parties for the purpose of commercially exploiting the Foreground Intellectual Property, to the extent that such access is required.

12.2. Title to Intellectual Property

- (a) All right, title and interest in and to Foreground Intellectual Property prepared conceived or developed by the Supplier, its researchers, agents and employees shall vest in Transnet and the Supplier acknowledges that it has no claim of any nature in and to the Foreground Intellectual Property. The Supplier shall not at any time during or after the termination or cancellation of the Agreement dispute the validity or enforceability of such Foreground Intellectual Property, or cause to be done any act or anything contesting or in any way impairing or tending to impair any part of that right, title and interest to any of the Foreground Intellectual Property and shall not counsel or assist any person to do so.
- (b) Transnet shall be entitled to seek protection in respect of the Foreground Intellectual Property anywhere in the world as it shall decide in its own absolute discretion and the Supplier shall reasonably assist Transnet in attaining and maintaining protection of the Foreground Intellectual Property.
- (c) Where the Foreground Intellectual Property was created by the Supplier or its researchers, agents and employees and where Transnet elects not to exercise its option to seek protection or decides to discontinue the financial support of the prosecution or maintenance of any such protection, Transnet shall notify the Supplier who shall have the right of first refusal to file or continue prosecution or maintain any such applications and to maintain any protection issuing on the Foreground Intellectual Property.

Respondent's Signature

Date & Company Stamp

- (d) No consideration shall be paid by Transnet to the Supplier for the assignment of any Foreground Intellectual Property from the Supplier to Transnet, over and above the sums payable in terms of the Agreement. The Supplier undertakes to sign all documents and do all things as may be necessary to effect, record and perfect the assignment of the Foreground Intellectual Property to Transnet.
- (e) Subject to anything contrary contained in the Agreement and/or the prior written consent of Transnet (which consent shall not be unreasonably withheld), the Supplier shall under no circumstances be entitled as of right, or to claim the right, to use Transnet's Background Intellectual Property and/or Foreground intellectual Property.

12.3. Title to Improvements

Any improvements, developments, adaptations and/or modifications to the Foreground Intellectual Property, and any and all new inventions or discoveries, based on or resulting from the use of Transnet's Background Intellectual Property and/or Confidential Information shall be exclusively owned by Transnet. The Supplier shall disclose promptly to Transnet all such improvements, developments, adaptations and/or modifications, inventions or discoveries. The Supplier hereby undertakes to sign all documents and do all things as may be necessary to effect, record and perfect the assignment of such improvements, developments, adaptations and/or modifications, inventions or discoveries to Transnet and the Supplier shall reasonably assist Transnet in attaining, maintaining or documenting ownership and/or protection of the improved Foreground Intellectual Property.

12.4. Unauthorised Use of Confidential Information

The Supplier shall not authorise any party to act on or use in any way any Confidential Information belonging to Transnet whether or not such party is aware of such Confidential Information, and shall promptly notify Transnet of the information if it becomes aware of any party so acting, and shall provide Transnet the information with such assistance as Transnet reasonably requires, at Transnet's cost and expense, to prevent such third party from so acting.

12.5. Unauthorised Use of Intellectual Property

- (a) The Supplier agrees to notify Transnet in writing of any conflicting uses of, and applications of registrations of Patents, Designs and Trade Marks or any act of infringement, unfair competition or passing off involving the Intellectual Property of Transnet of which the Supplier acquires knowledge and Transnet shall have the right, as its own option, to proceed against any party infringing its Intellectual Property.

Respondent's Signature

Date & Company Stamp

- (b) It shall be within the discretion of Transnet to determine what steps shall be taken against the infringer and the Supplier shall co-operate fully with Transnet, at Transnet's cost, in whatever measure including legal action to bring any infringement of illegal use to an end.
- (c) The Supplier shall cooperate to provide Transnet promptly with all relevant ascertainable facts.
- (d) If proceedings are commenced by Transnet alone, Transnet shall be responsible for all expenses but shall be entitled to all damages or other award arising out of such proceedings. If proceedings are commenced by both Parties, both Parties will be responsible for the expenses and both Parties shall be entitled to damages or other award arising out of proceedings.

13. SUPPLIER'S PERSONNEL

- 13.1. The Supplier's Personnel shall be regarded at all times as employees, agents or Subcontractors of the Supplier and no relationship of employer and employee shall arise between Transnet and any Supplier Personnel under any circumstances regardless of the degree of supervision that may be exercised over the Personnel by Transnet.
- 13.2. The Supplier warrants that all its Personnel will be entitled to work in South Africa or any other country in which the Services are to be performed.
- 13.3. The Supplier will ensure that its Personnel comply with all reasonable requirements made known to the Supplier by Transnet concerning conduct at any Transnet premises or any other premises upon which the Services are to be performed (including but not limited to security regulations, policy standards and codes of practice and health and safety requirements). The Supplier will ensure that such Personnel at all times act in a lawful and proper manner in accordance with these requirements.
- 13.4. Transnet reserves the right to refuse to admit or to remove from any premises occupied by or on behalf of it, any Supplier Personnel whose admission or presence would, in the reasonable opinion of Transnet, be undesirable or who represents a threat to confidentiality or security or whose presence would be in breach of any rules and regulations governing Transnet's Personnel, provided that Transnet notifies the Supplier of any such refusal (with reasons why). The reasonable exclusion of any such individual from such premises shall not relieve the Supplier from the performance of its obligations under the Agreement.

Respondent's Signature

Date & Company Stamp

13.5. The Supplier agrees to use all reasonable endeavours to ensure the continuity of its Personnel assigned to perform the Services. If any re-assignment by the Supplier of those Personnel is necessary, or if Transnet advises that any such Personnel assigned are in any respect unsatisfactory, including where any such Personnel are, or are expected to be or have been absent for any period, then the Supplier will promptly supply a replacement of equivalent calibre and experience, and any such replacement shall be approved by Transnet prior to commencing provision of the Services, such approval not to be unreasonably withheld.

14. LIMITATION OF LIABILITY

14.1. Neither Party excludes or limits liability to the other Party for -

- (a) death or personal injury due to negligence; or
- (b) fraud.

14.2. The Supplier shall indemnify and keep Transnet indemnified from and against liability for damage to any Transnet property (whether tangible or intangible) or any other loss, costs or damage suffered by Transnet to the extent that it results from any act of or omission by the Supplier or its Personnel in connection with the Agreement. The Supplier's liability arising out of this sub-clause 14.2 shall be limited to a maximum amount payable in respect of any one occurrence or a series of related occurrences in a single calendar year, such amount to be agreed in writing by the Parties.

14.3. Subject always to sub-clauses 14.1 and 14.2 above, the liability of either the Supplier or Transnet under or in connection with the Agreement, whether for negligence, misrepresentation, breach of contract or otherwise, for direct loss or damage arising out of each Default or series of related Defaults shall not exceed 100% (one hundred percent) of the Fees paid under the schedule or Work Order to which the Default(s) relates.

14.4. Subject to sub-clause 14.1 above, and except as provided in sub-clauses 14.2 and 14.3 above, in no event shall either Party be liable to the other for indirect or consequential loss or damage or including indirect or consequential loss of profits, business, revenue, goodwill or anticipated savings of an indirect nature or loss or damage incurred by the other Party as a result of third party claims.

14.5. If for any reason the exclusion of liability in sub-clause 14.4 above is void or unenforceable, either Party's total liability for all loss or damage under the Agreement shall be as provided in sub-clause 14.3 above.

Respondent's Signature

Date & Company Stamp

14.6. Nothing in this clause 14 shall be taken as limiting the liability of the Supplier in respect of clause 12 (INTELLECTUAL PROPERTY RIGHTS) or clause 16 (CONFIDENTIALITY).

15. INSURANCES

15.1. Without limiting the liability of the Supplier under the Agreement, the Supplier shall take out insurance in respect of all risks for which it is prudent for the Supplier to insure against, including any liability it may have as a result of its activities under the Agreement for theft, destruction, death or injury to any person and damage to property. The level of insurance will be kept under review by Transnet, on an annual basis, to ensure its adequacy, provided that any variation to the level of such insurance shall be entirely at the discretion of the Supplier.

15.2. The Supplier shall arrange insurance with reputable insurers and will produce to Transnet evidence of the existence of the policies on an annual basis within 30 (thirty) days after date of policy renewals.

15.3. Subject to sub-clause 15.4 below, if the Supplier fails to effect adequate insurance under this clause 15, it shall notify Transnet in writing as soon as it becomes aware of the reduction or inadequate cover and Transnet may arrange or purchase such insurance. The Supplier shall promptly reimburse Transnet for any premiums paid provided such insurance protects the Supplier's liability. Transnet assumes no responsibility for such insurance being adequate to protect all of the Supplier's liability.

15.4. In the event that the Supplier receives written notice from its insurers advising of the termination of its insurance cover referred to in sub-clause 15.1 above or if the insurance ceases to be available upon commercially reasonable terms, the Supplier shall immediately notify Transnet in writing of such termination and/or unavailability, whereafter either the Supplier or Transnet may terminate the Agreement on giving the other Party not less than 30 (thirty) days prior written notice to that effect.

16. CONFIDENTIALITY

16.1. The Parties hereby undertake the following, with regard to Confidential Information -

- (a) not to divulge or disclose to any person whomsoever in any form or manner whatsoever, either directly or indirectly, any Confidential Information of the other, without the prior written consent of such other Party, other than when called upon to do so in accordance with a statute, or by a court having jurisdiction, or by any other duly authorised and empowered authority or official, in which event the Party concerned shall do what is

Respondent's Signature

Date & Company Stamp

reasonably possible to inform the other of such a demand and each shall assist the other in seeking appropriate relief or the instituting of a defensive action to protect the Confidential Information concerned;

- (b) not to use, exploit, permit the use of, directly or indirectly, or in any other manner whatsoever apply the Confidential Information, disclosed to it as a result of the Agreement, for any purpose whatsoever other than for the purpose for which it is disclosed or otherwise than in strict compliance with the provisions in the Agreement;
- (c) not to make any notes, sketches, drawings, photographs or copies of any kind of any part of the disclosed Confidential Information, without the prior written consent of such other Party, except when reasonably necessary for the purpose of the Agreement, in which case such copies shall be regarded as Confidential Information;
- (d) not to de-compile, disassemble or reverse engineer any composition, compilation, concept application, item, component de-compilation, including software or hardware disclosed and shall not analyse any sample provided by Transnet, or otherwise determine the composition or structure or cause to permit these tasks to be carried out except in the performance of its obligations pursuant to the Agreement;
- (e) not to exercise less care to safeguard Transnet Confidential Information than the Party exercises in safeguarding its own competitive, sensitive or Confidential Information;
- (f) Confidential Information disclosed by either Party to the other or by either Party to any other party used by such Party in the performance of the Agreement, shall be dealt with as "restricted" or shall be dealt with according to any other appropriate level of confidentiality relevant to the nature of the information concerned, agreed between the Parties concerned and stipulated in writing for such information in such cases;
- (g) the Parties shall not make or permit to be made by any other person subject to their control, any public statements or issue press releases or disclose Confidential Information with regard to any matter related to the Agreement, unless written authorisation to do so has first been obtained from the Party first disclosing such information;
- (h) each Party shall be entitled to disclose such aspects of Confidential Information as may be relevant to one or more technically qualified employees or consultants of the Party who are required in the course of their duties to receive the Confidential Information for the Permitted Purpose provided that the employee or consultant concerned has a legitimate interest therein, and then only to the extent necessary for the Permitted Purpose, and is

Respondent's Signature

Date & Company Stamp

informed by the Party of the confidential nature of the Confidential Information and the obligations of the confidentiality to which such disclosure is subject and the Party shall ensure such employees or consultants honour such obligations;

- (i) each Party shall notify the other Party of the name of each person or entity to whom any Confidential Information has been disclosed as soon as practicable after such disclosure;
 - (j) each Party shall ensure that any person or entity to which it discloses Confidential Information shall observe and perform all of the covenants the Party has accepted in the Agreement as if such person or entity has signed the Agreement. The Party disclosing the Confidential Information shall be responsible for any breach of the provisions of the Agreement by the person or entity; and
 - (k) each Party may by written notice to the other Party specify which of the Party's employees, officers or agents are required to sign a non-disclosure undertaking.
- 16.2. The duties and obligations with regard to Confidential Information in this clause 16 shall not apply where -
- (a) a Party can demonstrate that such information is already in the public domain or becomes available to the public through no breach of the Agreement by that Party, or its Personnel; or
 - (b) was rightfully in a Party's possession prior to receipt from the other Party, as proven by the first-mentioned Party's written records, without an infringement of an obligation or duty of confidentiality; or
 - (c) can be proved to have been rightfully received by a Party from a third party without a breach of a duty or obligation of confidentiality; or
 - (d) is independently developed by a Party as proven by its written records.

16.3. This clause 16 shall survive termination for any reason of the Agreement and shall remain in force and effect from the Commencement Date of the Agreement and 5 (five) years after the termination of the Agreement. Upon termination of the Agreement, all documentation furnished to the Supplier by Transnet pursuant to the Agreement shall be returned to Transnet including, without limitation all corporate identity equipment including dies, blocks, labels, advertising matter, printing matter and the like.

Respondent's Signature

Date & Company Stamp

17. TOTAL OR PARTIAL FAILURE TO PERFORM THE SCOPE OF SERVICES

Should the Supplier fail or neglect to execute the work or to deliver any portion of the Service, as required by the terms of the Agreement or Work Order, Transnet may cancel the Agreement or Work Order in so far as it relates to the unexecuted work or rejected portion of the Service, and, in such event, the provision of any remaining commitment shall remain subject in all respects to these conditions.

18. TERM AND TERMINATION

- 18.1. The Agreement shall commence on the Commencement Date, as specified in the schedules or Work Orders hereto, and shall continue subject to termination in accordance with the provisions of the Agreement or otherwise in accordance with law or equity.
- 18.2. Transnet may terminate the Agreement without cause by giving the Supplier 30 (thirty) days' notice in writing.
- 18.3. Either Party may terminate the Agreement forthwith by notice in writing to the other Party where the other Party has committed a material Default and, where such Default is capable of remedy, has failed to remedy such Default within 30 (thirty) days of receiving notice specifying the Default and requiring its remedy.
- 18.4. Either Party may terminate the Agreement forthwith by notice in writing to the other Party when the other Party is unable to pay its debts as they fall due or commits any act or omission which would be an act of insolvency in terms of the Insolvency Act, 1936 (as amended), or if any action, application or proceeding is made with regard to it for -
- (a) a voluntary arrangement or composition or reconstruction of its debts;
 - (b) the presentation of an administrative petition;
 - (c) its winding-up or dissolution;
 - (d) the appointment of a liquidator, trustee, receiver, administrative receiver or similar officer;
- or
- (e) any similar action, application or proceeding in any jurisdiction to which it is subject.
- 18.5. Transnet may terminate the Agreement at any time within 2 (two) months of becoming aware of a change of control of the Supplier by notice in writing to the Supplier. For the purposes of this clause, "control" means the right to direct the affairs of a company whether by ownership of shares, membership of the board of directors, agreement or otherwise.

 Respondent's Signature

 Date & Company Stamp

18.6. Transnet may cancel any schedule hereto or Work Order at any time on giving the Supplier 30 (thirty) days' notice.

19. CONSEQUENCE OF TERMINATION

19.1. Termination in accordance with clause 18 (TERM AND TERMINATION) shall not prejudice or affect any right of action or remedy which shall have accrued or shall thereafter accrue to either Party and all provisions which are to survive the Agreement or impliedly do so shall remain in force and in effect.

19.2. On termination of the Agreement or a Work Order, the Supplier will immediately deliver up, and procure that its Personnel will immediately deliver up to Transnet, all Deliverables and property belonging to Transnet (or, in the event of termination of a Work Order, such as is relevant to that Work Order) which may be in the possession of, or under the control of the Supplier, and certify to Transnet in writing that this has been done.

19.3. To the extent that any of the Deliverables and property referred to in sub-clause 19.2 above are in electronic form and contained on non-detachable storage devices, the Supplier will provide Transnet with unencrypted copies of the same on magnetic media and will irretrievably destroy and delete copies so held.

19.4. In the event that the Agreement is terminated by the Supplier under sub-clause 18.3 (TERM AND TERMINATION), or in the event that a Work Order is terminated by Transnet under sub-clause 18.6 (TERM AND TERMINATION), Transnet will pay to the Supplier all outstanding Fees (apportioned on a pro rata basis) relating to the work undertaken by the Supplier up until the date of such termination. Transnet will also pay the costs of any goods and materials ordered by the Supplier in relation to the such work for which the Supplier has paid or is legally obliged to pay, in which case, on delivery of such goods or materials, the Supplier will promptly deliver such goods and materials to Transnet or as it may direct.

19.5. The provisions of clauses 2 (DEFINITIONS), 6 (WARRANTIES), 12 (INTELLECTUAL PROPERTY RIGHTS), 14 (LIMITATION OF LIABILITY), 16 (CONFIDENTIALITY), 19 (CONSEQUENCE OF TERMINATION), 25 (DISPUTE RESOLUTION) and 29 (GOVERNING LAW) shall survive termination or expiry of the Agreement.

19.6. If either Party (the "Defaulting Party") commits a material breach of the Agreement and fails to remedy such breach within 30 (thirty) Business Days of written notice thereof, the other Party (hereinafter the "Aggrieved Party"), shall be entitled, in addition to any other rights and remedies that it may have in terms of the Agreement, to terminate the Agreement forthwith without any

Respondent's Signature

Date & Company Stamp

liability and without prejudice to any claims which the Aggrieved Party may have for damages against the Defaulting Party.

19.7. Should -

- (a) the Supplier effect or attempt to effect a compromise or composition with its creditors; or
- (b) either Party be provisionally or finally liquidated or placed under judicial management, whether provisionally or finally; or
- (c) either Party cease or threaten to cease to carry on its normal line of business or default or threaten to default in the payment of its liabilities generally, or commit any act or omission which would be an act of insolvency in terms of the Insolvency Act, 1936 (as amended);

then the other Party shall be entitled, but not obliged, to terminate the Agreement on written notice, in which event such termination shall be without any liability and without prejudice to any claims which either Party may have for damages against the other.

20. ASSIGNMENT

Neither Party may assign the benefit of the Agreement or any interest hereunder except with the prior written consent of the other. Further, in the event that Transnet wishes to assign or novate the Agreement to any third party, the Supplier agrees that it shall not unreasonably withhold or delay its consent to such assignment or novation and that it shall only be entitled to recover from Transnet any reasonable legal costs incurred by it as a direct result of such assignment or novation.

21. FORCE MAJEURE

21.1. Neither Party shall have any claim against the other Party arising from any failure or delay in the performance of any obligation of either Party under the Agreement caused by an act of force majeure such as acts of God, fire, flood, war, strike, lockout, industrial dispute, government action, laws or regulations, riots, terrorism or civil disturbance, defaults, delays or discontinuance on the part of independent contractors, suppliers, or other circumstances or factors beyond the reasonable control of either Party, and to the extent that the performance of obligations of either Party hereunder is delayed by virtue of the foregoing, any period stipulated for any such performance shall be reasonably extended.

21.2. Each Party will take all reasonable steps by whatever lawful means that are available, to resume full performance as soon as practicable and will seek agreement to modification of the relevant provisions of the Agreement in order to accommodate the new circumstances caused by the act of force majeure. If a Party fails to agree to such modifications proposed by the other

Respondent's Signature

Date & Company Stamp

Party within 90 (ninety) days of the act of force majeure first occurring, either Party may thereafter terminate the Agreement with immediate notice.

22. EQUALITY AND DIVERSITY

- 22.1. The Supplier will not victimise, harass or discriminate against any employee of either Party to the Agreement or any applicant for employment with either Party to the Agreement due to their gender, race, disability, age, religious belief, sexual orientation or part-time status. This provision applies, but is not limited to employment, upgrading, work environment, demotion, transfer, recruitment, recruitment advertising, termination of employment, rates of pay or other forms of compensation and selection for training.
- 22.2. Both Parties to the Agreement undertake that they will not, and shall procure that its employees, agents and Subcontractors will not breach any applicable discrimination legislation and any amendments and re-enactments thereof.

23. NON-WAIVER

- 23.1. Failure or neglect by either Party, at any time, to enforce any of the provisions of the Agreement, shall not, in any manner, be construed to be a waiver of any of that Party's rights in that regard and in terms of the Agreement.
- 23.2. Such failure or neglect shall not, in any manner, affect the continued, unaltered validity of the Agreement, or prejudice the right of that Party to institute subsequent action.

24. PARTIAL INVALIDITY

If any provision of the Agreement shall be held to be invalid, illegal or unenforceable, or shall be required to be modified, the validity, legality and enforceability of the remaining provisions shall not be affected thereby.

25. DISPUTE RESOLUTION

- 25.1. Should any dispute of whatsoever nature arise between the Parties concerning the Agreement, the Parties shall try to resolve the dispute by negotiation within 10 (ten) Business Days of such dispute arising.
- 25.2. If the dispute has not been resolved by such negotiation, either of the Parties may refer the dispute to AFSA and notify the other Party accordingly.
- 25.3. Such dispute shall be finally resolved in accordance with the rules of AFSA by an arbitrator or arbitrators appointed by AFSA.

Respondent's Signature

Date & Company Stamp

25.4. This clause constitutes an irrevocable consent by the Parties to any proceedings in terms hereof, and neither of the Parties shall be entitled to withdraw from the provisions of this clause or claim at any such proceedings that it is not bound by this clause 25.

25.5. This clause 25 is severable from the rest of the Agreement and shall remain in effect even if the Agreement is terminated for any reason.

25.6. This clause 25 shall not preclude either Party from seeking urgent relief in a court of appropriate jurisdiction, where grounds for urgency exist.

26. ADDRESSES FOR NOTICES

26.1. The Parties to the Agreement select the physical addresses and facsimile ("fax") numbers, detailed in Schedule 1 hereto, as their respective addresses for giving or sending any notice provided for or required in terms of the Agreement, provided that either Party shall be entitled to substitute such other address or fax number, as may be, by written notice to the other.

26.2. Any notice addressed to a Party at its physical or postal address shall be sent by prepaid registered post, or delivered by hand, or sent by fax.

26.3. Any notice shall be deemed to have been given -

- (a) if posted by prepaid registered post, 10 (ten) days after the date of posting thereof;
- (b) if hand delivered, on the day of delivery; or
- (c) if faxed, on the date and time of sending of such fax, as evidenced by a fax confirmation printout, provided that such notice shall be confirmed by prepaid registered post on the date of dispatch of such fax, or, should no postal facilities be available on that date, on the next Business Day.

27. WHOLE AND ONLY AGREEMENT

27.1. The Parties hereby confirm that the Agreement constitutes the whole and only agreement between them with regard to the subject matter of the Agreement.

27.2. The Parties hereby confirm that the Agreement replaces all other agreements which exist or may have existed in any form whatever between them, with regard to the subject matter dealt with in the Agreement, including any annexures, schedules or Work Order(s) appended hereto.

Respondent's Signature

Date & Company Stamp

28. AMENDMENT AND CHANGE CONTROL

28.1. Any requirement for an amendment or change to the Agreement or to the Schedule of Requirements or to a Work Order shall only be valid if it is in writing, signed by both Parties and added to the Agreement as an addendum hereto.

28.2. In the event the Parties cannot agree upon changes, the Parties shall in good faith seek to agree any proposed changes using the dispute resolution procedures in clause 25 (DISPUTE RESOLUTION).

29. GOVERNING LAW

The Agreement is exclusively governed by and construed in accordance with the laws of the Republic of South Africa and is subject to the jurisdiction of the courts of the Republic of South Africa.

29.1. **Change of Law:** In the Agreement, unless the context otherwise requires, references to a statutory provision include references to that statutory provision as from time to time amended, extended or re-enacted and any regulations made under it, provided that in the event that the amendment, extension or re-enactment of any statutory provision or introduction of any new statutory provision has a material impact on the obligations of either Party, the Parties will negotiate in good faith to agree such amendments to the Agreement as may be appropriate in the circumstances. If, within a reasonable period of time, the Supplier and Transnet cannot reach agreement on the nature of the changes required or on modification of Fees, Deliverables, warranties, or other terms and conditions, either Party may seek to have the matter determined in accordance with clause 25 (DISPUTE RESOLUTION) above.

30. COUNTERPARTS

The Agreement may be signed in any number of counterparts, all of which taken together shall constitute one and the same instrument. Either Party may enter into the Agreement by signing any such counterpart.

oooOOooo

Respondent's Signature

Date & Company Stamp